

2017



WGP MX2
TEAM SUZUKI
JEREMY SEEWER

ZETA
HIGH PERFORMANCE PRODUCTS

DRC
HARDWARE

CATALOG

Yoshimura Suzuki Shell ADVANCE Racing Team



Photo credit: Yoshimura Japan

JAPAN MOTOCROSS



YAMAHA FACTORY RACING TEAM



KAWASAKI RACING TEAM



TEAM SUZUKI



UZUSHIO RACING

TEAM SRM **SRF TEAM REDZONE** **TEAM SRF Team BLUE EAGLES** **Flying Dolphin Sansei**

WORLD MOTOCROSS



WMXGP 24MX HONDA RACING



WMXGP SUZUKI EUROPE

WMXGP
KEMEA RACING YAMAHA
SUZUKI REINECKE

MX NATIONALS
PENRITE HONDA RACING
DPH YAMAHA RACING



Rest in Peace

FMX
Paul Smith



FMX Taka Higashino
Clinton Moore
Brody Wilson
Keith Sayers

TEAM MX-VIRUS
TEAM THUGWAY



ENDURO

Kenji Suzuki
Taichi Tanaka
Yutaro Uchiyama
Masami Ishii
Kazuhiro Yoshikawa
Takeshi Koikeda



RALLY CRF250L Patric Trahan



TRIAL Fumitaka Nozaki



SUPER MOTARD

Tomoyoshi Masuda
Ikki Morita
Takahiro Ikeda



SUZUKA 8h
YOSHIMURA SUZUKI
Shell ADVANCE RACING TEAM
Photo credit: Yoshimura Japan



SBK YAMALUBE / WESTBY RACING TEAM



SBK YOSHIMURA SUZUKI FACTORY RACING
CRESCENT YAMAHA

INDEX		OFF
Z ZETA	CONTROL	4-10
	BARCLAMP	11-15
	LEVER	16-20
	FOOT PARTS	21-24
	HAND GUARD	25-28
	BODY GUARD	29-33
	BODY	34-48
	ACCESSORIES	49
Z Z CARBON	CARBON	50-53
Z WHEEL	WHEEL	54-63
	BRAKE DISC	64
	BRAKE HOSE	65
	STICKER	66
Z ZETA	TITANIUM	68-79
Z ZETA	CONTROL	80-85
	LEVER	86-90
	BODY	91-98
	ELECTRICAL	99
ABC	STAND	100-101
	TRANSPORT	102-105
	TOOL	106-119
	CONTROL	120-121
	EXHAUST	122-123
	ELECTRICAL	124-131
	DRIVE	132-135
	BODY	136-144
	ACCESSORIES	145
M motion	COVER DECAL	146-147
M MUDOFF	MUD PARTS	148-149
DELTA	EXHAUST	150-151
DFG	INNER WEAR	152-154



SX3

TAPERTUBE HANDLEBAR

7075-T6
ALUMINUM

ZETA

SX-3 HANDLEBAR 1 1/8 in (28.6 mm)

- ZETA revolutionary over-sized handlebar.
- Tested and developed by Japanese factory riders.
- Made of A7075-T6 aluminum for strength and durability.
- Knurled grip area to resist slippage.
- Many bends available for MX racers, ED, Mini racer, Free style, Super Motard, and Trial.
- Included large size foam bar pad.
- Available in black, red and blue colors.

- 1 Black
- 2 Blue
- 3 Red

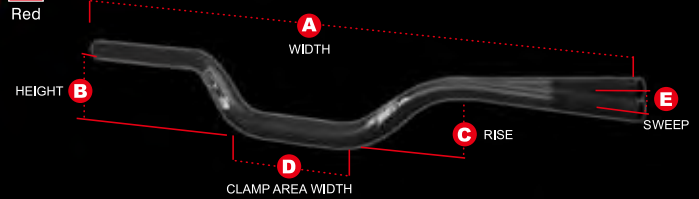

CONTROL

BARCLAMP

LEVER

FOOT PARTS

HAND GUARD

BODY GUARD

BODY

ACCESSORIES

CARBON



Tapered handlebar provides high rigidity and shock absorption.



Comes with large foam SX Bar pad.



Plastic bar end caps installed.

Model	Part #	Handlebar dimensions					Color	Approximate bend
		A	B	C	D	E		
MX-111	ZE06-111 #	806	83	49	215	53	1 2 3	CR/CRF-Low, KXF-Low
MX-123	ZE06-123 #	806	98	64	215	53	1 2 3	CR125R/250R'04-07, CRF250R'04-17, CRF450R'04-17, CRF450RX'17, KX125/250/250F/450F'06-17, KLX450R'08-09
MX-214	ZE06-214 #	803	95	57	213	54	1 2 3	KX125/250'03-05, RM125/250'02-05, RMZ250'04-06, KX250F'04-05
MX-313	ZE06-313 #	805	80	52	205	60	1 2 3	RM125/250'06-, RMZ250'07-17, RMZ450'05-17, DRZ400SM, 125/150SX'08-12, 250SX'08-12, 250/350/450SX-F'08-12, 250XC-F'11-12, 350XC-F'12
MX-414	ZE06-414 #	803	84	55	209	49	1 2 3	YZ125/250'06-17, YZ250F'06-17, YZ450F'06-17, YZ125X'17, YZ250X'16-17, YZ250FX'15-17, YZ450FX'16-17
MX-542	ZE06-542 #	811	79	42	195	50	1	KTM SX/SX-F'16-
MX-543	ZE06-543 #	805	88	61	205	40	1	KTM EXC/EXC-F'16-
Super-Low	ZE06-602 #	805	65	29	200	48	1	
ED-Low	ZE06-631 #	805	73	53	205	72	1	XR250/Baja/Motard
ED-Medium	ZE06-635 #	815	88	68	205	72	1	
ED-High	ZE06-638 #	825	103	83	215	72	1	
Motard-High	ZE06-658 #	825	107	79	215	64	1	
Super Moto-Low	ZE06-661 #	800	80	45	200	62	1	
Super Moto-Medium	ZE06-665 #	800	95	60	200	62	1	
FMX	ZE06-671 #	802	108	70	220	54	1	EIGO SATO MODEL
FMX-TAKA	ZE06-674 #	777	123	70	228	56	1	TAKA HIGASHINO MODEL
Trial Competition	ZE06-754 #	797	99	62	178	45	1	FUMITAKA NOZAKI MODEL
Mini Racer-Low	ZE06-922 #	740	95	62	190	55	1	RM85, KX85
Mini Racer-Medium	ZE06-931 #	750	110	77	195	55	1	CR85, CRF150R, YZ85
Mini Racer-High	ZE06-942 #	760	125	92	205	55	1	

#Add color number to complete number for ordering.

UZUSHIO RACING JMX

YUUI HOSHINO

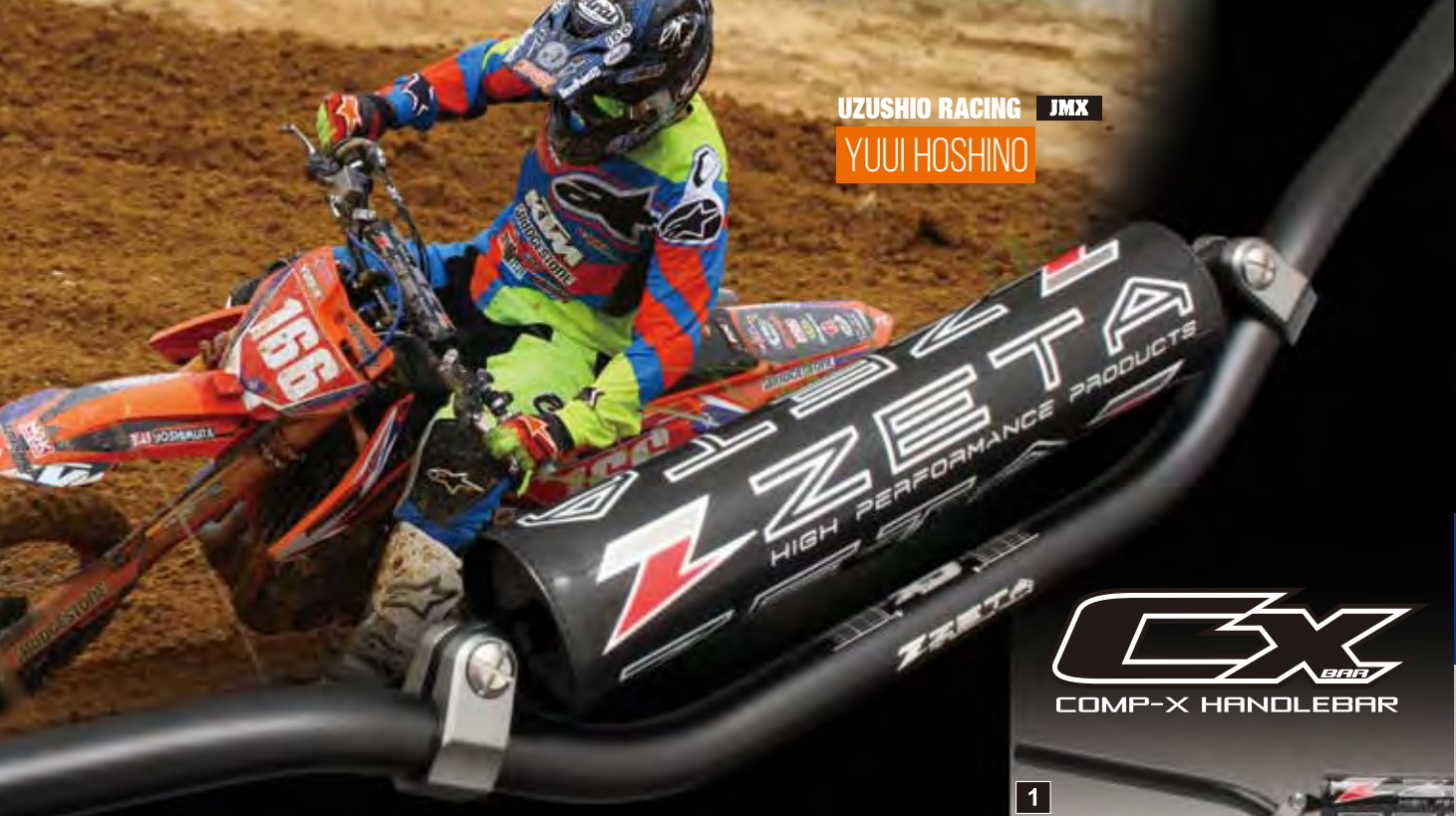

ZETA
CX HANDLEBAR 7/8 in (22.2 mm)

- ZETA 22.2mm handlebar for top riders.
- Made of durable 7075-T6 aluminum with brace on the handlebar to provide direct control.
- Laser printed logos and handlebar positioning gauge for accurate handlebar position setting.
- Knurled grip area to resist slippage.
- Comes with plastic bar end cap and comp handlebar pad.
- Many bends available for MX racers, ED, Mini racers, Super motard and Trial.
- Available in black, red and blue colors.

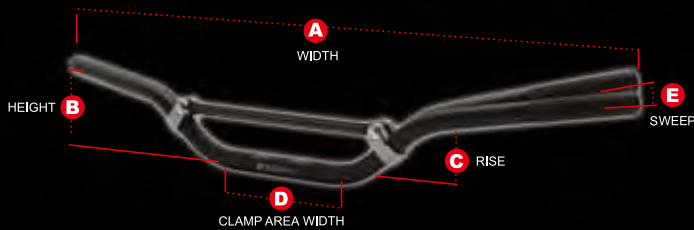

7075-T6 ALUMINUM

Model	Part #	Handlebar dimensions					Color	Approximate bend
		A	B	C	D	E		
MX-111	ZE09-111 #	806	83	49	215	53	1 2 3	CR/CRF-Low, KXF-Low
MX-121	ZE09-121 #	797	87	49	210	55	1	CR125R/250R'02-03, CRF450R'02-03
MX-123	ZE09-123 #	806	98	64	215	53	1 2 3	CR125R/250R'04-07, CRF250R'04-17, CRF450R'04-16, KX125/250/250F/450F'06-17, KLX450R'08-09
MX-214	ZE09-214 #	803	95	57	213	54	1 2 3	KX125/250'03-05, RM125/250'02-05, RMZ250'04-06, KX250F'04-05
MX-412	ZE09-412 #	800	90	63	213	58	1 2 3	YZ125/250/250F/450F'03-05, WR250F/450F03-05
ED-Medium	ZE09-635 #	815	88	68	205	72	1	
ED-High	ZE09-638 #	825	103	83	215	72	1	
Dual Sport-Low	ZE09-641 #	800	75	46	200	78	1 2 3	XR250/Baja/Motard, XR230/Motard, SEROW225
Dual Sport-Medium	ZE09-645 #	800	90	61	200	78	1 2 3	DRZ400S/SM, KLX250'07, D-TRACKER'07, CRF250L/M
Super Moto-Low	ZE09-661 #	800	80	45	200	62	1 2 3	SEROW250
Super Moto-Medium	ZE09-665 #	800	95	60	200	62	1 2 3	KLX250'08-15, D-TRACKER'08-15, WR250R/X
Trial-5.0inch	ZE09-750 #	820	116	75	186	54	1	
Mini Racer-Low	ZE09-922 #	740	95	62	190	55	1	RM85, KX85
Mini Racer-Medium	ZE09-931 #	750	110	77	195	55	1	CR85, CRF150R, YZ85
Mini Racer-High	ZE09-942 #	760	125	92	205	55	1	

#Add color number to complete number for ordering.

COMP-X HANDLEBAR

- 1 Black
- 2 Blue
- 3 Red



Laser printed logos and handlebar positioning gauge for accurate handlebar position setting.



Comes with high gloss bar pad.



Plastic bar end caps installed.

CONTROL

BARCLAMP

LEVER

FOOT PARTS

HAND GUARD

BODY GUARD

BODY

ACCESSORIES

CARBON

CONTROL



BARCLAMP



LEVER



FOOT PARTS



HAND GUARD



BODY GUARD



BODY



ACCESSORIES



CARBON



SOLID

TAPERTUBE HANDLEBAR

ZETA

SOLID HANDLEBAR 1 1/8 in (28.6 mm)

- Oversized (28.6 mm) handlebar for all riders.
- Available in MX / ED and dual sports bends.
- Available in blue, red and titanium colors.
- Knurled grip area to resist slippage.
- Laser printed handlebar position grid.
- Comes with plastic bar end caps.

2
Blue

3
Red

8
Titanium

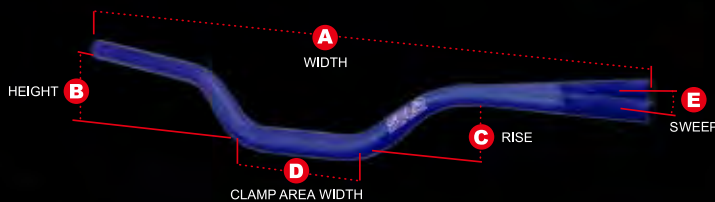

Laser printed logos and handlebar positioning gauge for accurate handlebar position setting.



Plastic bar end caps installed.

Model	Part number	Handlebar dimensions					Color		
		A	B	C	D	E	2	3	8
MX/ED-Low	ZE04-111 #	806	83	49	215	53	2	3	8
MX/ED-Medium	ZE04-123 #	806	98	64	215	53	2	3	8
Motard/Sport-Low	ZE04-661 #	800	80	45	200	62		3	8
Motard/Sport-Medium	ZE04-665 #	800	95	60	200	62	2	3	8

#Add color number to complete number for ordering.

ZETA

SX BAR PAD

- Large form SX bar pad.
- Wrapped in a sleek vinyl cover.
- Provides rider protection while padding the bar mount area.

Part number **ZE01-0132** Color Black





COMP

7/8" (22.2mm) HANDLEBAR



2
Blue

3
Red

8
Titanium

ZETA COMP HANDLEBAR 7/8 in (22.2mm)

- Upgrade comp handlebar for all riders.
- Made of a stronger durable material.
- Available in titanium, red and blue anodized colors.
- Knurled grip area to resist slippage.
- Comes with plastic bar end caps.
- Laser printed position grid.

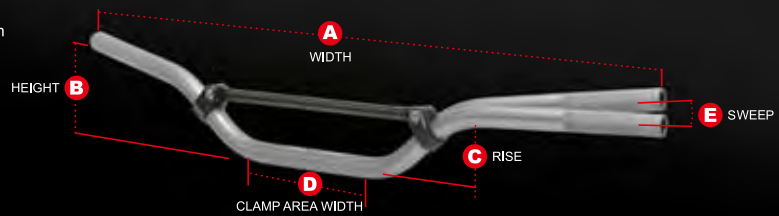

Plastic bar end caps installed.



Laser printed logos and handlebar positioning gauge for accurate handlebar position setting.

Model	Part #	Handlebar dimensions					Color	Approximate bend
		A	B	C	D	E		
MX/ED-Low	ZE07-111#	806	83	49	215	53	8	YZ/YZF, RM/RMZ
Dual Sport-Low	ZE07-641#	800	75	46	200	78	2 3 8	XR250/Baja/Motard, XR230/Motard, SEROW225
Dual Sport-Medium	ZE07-645#	800	90	61	200	78	2 3 8	DRZ400S/SM, KLX250-'07, D-TRACKER-'07, CRF250L/M
Motard-Low	ZE07-661#	800	80	45	200	62	2 3 8	SEROW250
Motard-Medium	ZE07-665#	800	95	60	200	62	2 3 8	KLX250'08-16, D-TRACKER'08-16, WR250R/X
50-Mini	ZE07-902#	715	215	193	145	40	8	CRF50, TTR50, DRZ50/70
110-Mini	ZE07-904#	743	173	144	190	45	8	KLX110/L
Mini-Trail	ZE07-993#	775	106	80	181	60	2 3 8	KLX125, D-TRACKER125, KLX150S

#Add color number to complete number for ordering.

ZETA COMP BAR PAD

- Provides rider protection while padding the bar mount area.
- Graphics resistant to power washers and stains.
- Available in 4 colors.



Standard size	254 mm (10")	Mini size	220 mm (8.8")	Kids size	195 mm (7.8")
Part number		Part number		Part number	
Color	Blue	Color	Blue	Color	White
	ZE47-9131		ZE47-9231		ZE47-9336
	ZE47-9132		ZE47-9232		
	ZE47-9133				
	ZE47-9134				
	ZE47-9135				

- CONTROL
- BARCLAMP
- LEVER
- FOOT PARTS
- HAND GUARD
- BODY GUARD
- BODY
- ACCESSORIES
- CARBON

RACE GRIPS



CONTROL



BARCLAMP



LEVER



FOOT PARTS



HAND GUARD



BODY GUARD



BODY



ACCESSORIES



CARBON



ZETA RACE GRIPS

- Dual compound motocross and enduro racing grip available from ZETA.
- Grip body in gray is made of soft compound to reduce shock, while durable inner layer and grip end improve bar adhesion and give longer grip life.
- Provides greater grip with upper side anti slip diamond pattern, and better finger grip with lower in half waffle pattern.
- Incorporates 3 safety wire grooves to allow accurate and secure grip placement.
- Available in 4 different colors.
- Length 119 mm



CLOSED END

Part number **Color**
ZE47-5000 Black / Gray
ZE47-5002 Red / Gray

Part number **Color**
ZE47-5003 Orange / Gray
ZE47-5006 Blue / Gray



OPEN END

Part number **Color**
ZE47-5100 Black / Gray
ZE47-5102 Red / Gray

Part number **Color**
ZE47-5103 Orange / Gray
ZE47-5106 Blue / Gray

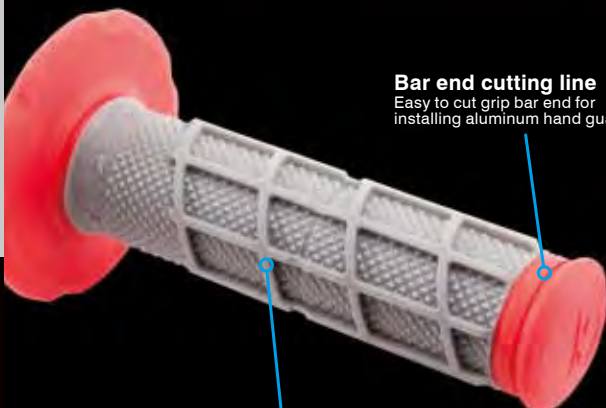

Bar end cutting line
 Easy to cut grip bar end for installing aluminum hand guards.

Twist half waffle pattern
 Lower twist half waffle pattern for better finger grip.

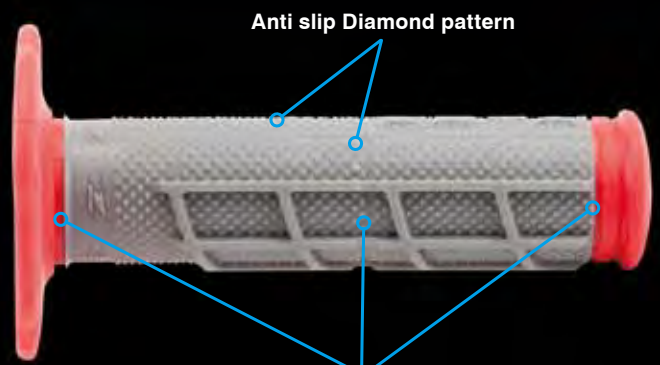

Anti slip Diamond pattern

3 safety wire grooves

	Bike	Year	Standard	Hi Speed
HONDA	CRF150R	07-17	ZE45-5015	-
	CRF250R/X	04-17	ZE45-5007	-
	CRF450R	04-17	ZE45-5007	-
	CRF450RX	17	ZE45-5007	-
	CRF450X	05-17	ZE45-5007	-
YAMAHA	YZ250F	98-11	ZE45-5001	ZE45-5101
		12-17	ZE45-5014	-
	YZ400F-450F	98-13	ZE45-5001	ZE45-5101
	YZ450F	14-15	ZE45-5014	-
		16-17	ZE45-5001	-
	YZ250FX	15-17	ZE45-5014	-
	YZ450FX	16-17	ZE45-5014	-
		01-14	ZE45-5001	ZE45-5101
	WR250F	15-16	ZE45-5014	-
		98-15	ZE45-5001	ZE45-5101
	16	ZE45-5014	-	
	WR400F-450F	00-16	ZE45-5001	ZE45-5101
	SEROW225/250,TRICKER	06-16	ZE45-5001	ZE45-5101
	XT250X	06-16	ZE45-5001	ZE45-5101
	WR250R/X	07-17	ZE45-5001	ZE45-5101
KAWASAKI	KX250F	04-17	ZE45-5001	ZE45-5101
	KX450F	06-17	ZE45-5001	ZE45-5101
	KLX450R	08-09	ZE45-5001	ZE45-5101
	KLX125,D-TRACKER125	10-16	ZE45-5001	ZE45-5101
	KLX150S	09-13	ZE45-5001	ZE45-5101
	KLX250,D-TRACKER	04-16	ZE45-5001	ZE45-5101
SUZUKI	RMZ250	04-06	ZE45-5001	ZE45-5101
		07-17	ZE45-5014	-
		05-06	ZE45-5001	ZE45-5101
	RMZ450	07	ZE45-5014	-
		08-17	ZE45-5001	ZE45-5101
		10-16	ZE45-5001	ZE45-5101
	DRZ400R/S/SM	00-16	-	ZE45-5111
	DR250S/R	92-04	-	ZE45-5111
	250SB	04-06	ZE45-5001	ZE45-5101
KTM	250SX-F/XC-F	06-15	ZE45-5021	-
	250EXC-F/XCF-W	06-16	ZE45-5021	-
	350SX-F/XC-F	11-15	ZE45-5021	-
	350EXC-F/XCF-W	12-16	ZE45-5021	-
	450SX-F/XC-F	06-15	ZE45-5021	-
	450EXC/XC-W	06-16	ZE45-5021	-
HUSQVARNA	400-530SX-R/EXC	04-16	ZE45-5021	-
	FC250-450	14-15	ZE45-5021	-
	FE250-501	14-16	ZE45-5021	-



ZETA ALUMINIUM THROTTLE TUBE

- Made of A6061 aluminum with hard anodized finish.
- Removable end cap design allows the use with bar end plugs or aluminum hand guards.
- High throttle tubes available for dual sport models for better acceleration.
- Special tapered inside tube design keeps the distance between the throttle tube inner and handlebar. Greatly reduce frictional resistance and allows smooth acceleration.

Aluminum throttle tube cutaway view

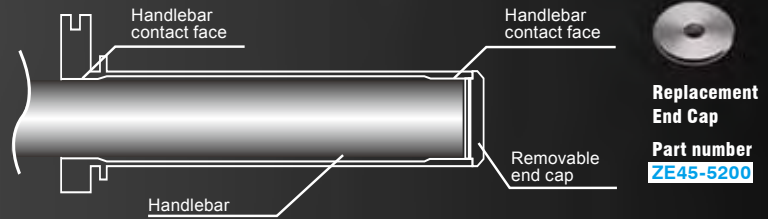

Replacement End Cap
Part number **ZE45-5200**

	Bike	Year	Closed End	Open End	
KAWASAKI	KX60/65/80/85/100	89-17	ZE45-8004	ZE45-8104	
		92-02	-	ZE45-8103	
	KX125/250	03-08	ZE45-8008	ZE45-8108	
		04-12	ZE45-8001	ZE45-8101	
	KX250F	13	ZE45-8023	ZE45-8123	
		14-17	ZE45-8001	ZE45-8101	
		06-12	ZE45-8001	ZE45-8101	
	KX450F	13	ZE45-8023	ZE45-8123	
		14-17	ZE45-8001	ZE45-8101	
		08-14	ZE45-8001	ZE45-8101	
		KDX125/200/220/250	89-	ZE45-8004	ZE45-8104
		KLX110	10-17	ZE45-8004	ZE45-8104
		KLX125,D-TRACKER125	10-16	ZE45-8023	ZE45-8123
		KLX140	08-16	ZE45-8004	ZE45-8104
		KLX150S	09-13	ZE45-8023	ZE45-8123
SUZUKI	KLX250, D-TRACKER	93-03	ZE45-8002	ZE45-8102	
		04-16	ZE45-8023	ZE45-8123	
	RM80/85	95-16	-	ZE45-8103	
	RM125/250	95-08	-	ZE45-8103	
	RMZ250	04-06	ZE45-8001	ZE45-8101	
		07-17	ZE45-8014	ZE45-8114	
		05-06	ZE45-8001	ZE45-8101	
	RMZ450	07	ZE45-8014	ZE45-8114	
		08-17	ZE45-8001	ZE45-8101	
		10-16	ZE45-8001	ZE45-8101	
KTM	TS125/200/R	89-97	ZE45-8004	ZE45-8104	
	RMX250S/R	89-98	ZE45-8004	ZE45-8104	
	DRZ125	01-16	ZE45-8004	ZE45-8104	
	DR250S/R	92-04	ZE45-8011	-	
	DRZ400S/R/SM	00-16	ZE45-8011	-	
		02-03	ZE45-8002	ZE45-8102	
		04-06	ZE45-8023	ZE45-8123	
		12-17	ZE45-8022	-	
		65SX	09-17	ZE45-8022	-
		85SX	04-17	ZE45-8020	ZE45-8120
	125-300SX/XC-W/EXC	04-16	ZE45-8020	ZE45-8120	
		17	ZE45-8025	-	
	250SX-F/XC-F	06-15	ZE45-8021	ZE45-8121	
		16-17	ZE45-8025	-	
	250EXC-F/XCF-W	06-16	ZE45-8021	ZE45-8121	
		17	ZE45-8025	-	
	350SX-F/XC-F	11-15	ZE45-8021	ZE45-8121	
		16-17	ZE45-8025	-	
	350EXC-F/XCF-W	12-16	ZE45-8021	ZE45-8121	
		17	ZE45-8025	-	
	450SX-F/XC-F	06-15	ZE45-8021	ZE45-8121	
		16-17	ZE45-8025	-	
	450EXC/XC-W	06-16	ZE45-8021	ZE45-8121	
		17	ZE45-8025	-	
	500EXC	17	ZE45-8025	-	
	400-530SX-R/EXC/XC-W	04-16	ZE45-8021	ZE45-8121	
	FREERIDE250R	14-17	ZE45-8020	ZE45-8120	
	FREERIDE350	13-17	ZE45-8021	ZE45-8121	
Husqvarna	TC85	14-17	ZE45-8020	ZE45-8120	
	TC125/250	14-16	ZE45-8020	ZE45-8120	
		17	ZE45-8025	-	
	TE125-300	14-16	ZE45-8020	ZE45-8120	
		17	ZE45-8025	-	
	FC250-450	14-15	ZE45-8021	ZE45-8121	
		16-17	ZE45-8025	-	
	TX/FX125-450	17	ZE45-8025	-	
	FE250-501	14-16	ZE45-8021	ZE45-8121	
		17	ZE45-8025	-	



ZETA THROTTLE TUBE

- Replaces stock throttle tube.
- Teflon coated nylon fabric provides smooth acceleration.
- Open end type available for use with aluminum hand guards and bar ends.

	Bike	Year	Closed End	Open End
HONDA	CR80R/85R	90-07	ZE45-8006	ZE45-8106
	CR125R/250R	95-05	ZE45-8005	ZE45-8105
	CRF150R	07-17	ZE45-8015	ZE45-8115
	CRF250R/X	04-17	ZE45-8007	ZE45-8107
	CRF450R	02-17	ZE45-8007	ZE45-8107
	CRF450RX	17	ZE45-8007	ZE45-8107
	CRF450X	05-17	ZE45-8007	ZE45-8107
	CRM250	91-96	ZE45-8010	ZE45-8110
		97-99	ZE45-8002	ZE45-8102
	CRF1000L	12-16	ZE45-8024	ZE45-8124
		16	-	ZE45-8124
	XR250/BAJA/MOTARD	95-07	ZE45-8013	ZE45-8113
	XR230/MOTARD	05-12	ZE45-8002	ZE45-8102
	XR400MOTARD	05-07	ZE45-8002	ZE45-8102
	XR250R,XLR250	-94	ZE45-8002	ZE45-8102
XR650R	00-07	ZE45-8002	ZE45-8102	
YAMAHA	YZ80/85	93-17	ZE45-8012	-
		96	-	ZE45-8103
	YZ125/250	97-17	ZE45-8009	ZE45-8109
		01-11	ZE45-8001	ZE45-8101
	YZ250F	12-17	ZE45-8014	ZE45-8114
	YZ400F-450F	98-13	ZE45-8001	ZE45-8101
	YZ450F	14-15	ZE45-8014	ZE45-8114
		16-17	ZE45-8001	ZE45-8101
	YZ125X	17	ZE45-8009	ZE45-8109
	YZ250X	16-17	ZE45-8009	ZE45-8109
	YZ250FX	15-17	ZE45-8014	ZE45-8114
	YZ450FX	16-17	ZE45-8014	ZE45-8114
	WR250F	01-14	ZE45-8001	ZE45-8101
		15-16	ZE45-8014	ZE45-8114
		98-15	ZE45-8001	ZE45-8101
	16	ZE45-8014	ZE45-8114	
	97-	ZE45-8012	-	
	DT230 LANZA	00-16	ZE45-8001	ZE45-8101
	SEROW225/250,TRICKER	06-16	ZE45-8001	ZE45-8101
	XT250X	06-16	ZE45-8001	ZE45-8101
	WR250R/X	07-17	ZE45-8001	ZE45-8101



ZETA BAR END PLUGS SWIVEL

- Fits throttle tube and allows smoother throttle movement than standard bar end plug. (Installation on the clutch side is the same as the standard bar end plug.)
- Made of 6061-T6 aluminum. Diameter : 29 mm (1.15 inch)
- Comes in pairs.

29 mm

Part number	Color
ZE48-8101	Silver
ZE48-8103	Titanium
ZE48-8104	Gold
ZE48-8105	Black
ZE48-8106	Red
ZE48-8107	Blue



(Throttle side Cutaway View)

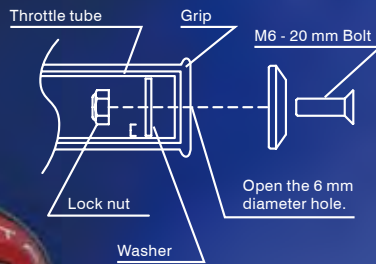

ZETA BAR END PLUGS 29 mm / 35 mm

- Prevents grip damage in the event of a fall.
- Light weight aluminum hardware.
- Available in 7 different colors for each size. (35 mm and 29 mm)
- Replacement parts available.

29 mm

Part number	Color
ZE48-7001	Silver
ZE48-7003	Titanium
ZE48-7004	Gold
ZE48-7005	Black
ZE48-7006	Red
ZE48-7007	Blue
ZE48-7009	Orange



35 mm

Part number	Color
ZE48-7101	Silver
ZE48-7103	Titanium
ZE48-7104	Gold
ZE48-7105	Black
ZE48-7106	Red
ZE48-7107	Blue
ZE48-7109	Orange



ZETA BAR END SLIDER

- Bar end slider made of durable POM material.
- Protects your throttle tube and grips from damages in a crash.
- Can be used handlebar inner diameter size from 13.5 mm to 19 mm

Part number	Color
ZE48-0010	Black



ZETA ROTATING BAR CLAMP UN

- Universal rotating bar clamp. Bolts on to your existing perch.
- Includes nylon sleeve to insert between the clamp and your bar allowing the perch to rotate upon impact.
- Made of A7009-T6 aluminum.

Part number	Color	Part number	Color
ZE40-9111	Titanium	ZE40-9098	Replacement nylon sleeve 180°
ZE40-9112	Red		
ZE40-9113	Blue		
ZE40-9114	Orange		



ZETA ROTATING BAR CLAMP MH

- Universal rotating bar clamp with mirror hole (10 mm). Bolts on to your existing perch.
- Includes nylon sleeve to insert between the clamp and your bar allowing the perch to rotate upon impact.
- Made of A7009-T6 aluminum.

Part number	Color	Part number	Color
ZE40-9411	Titanium	ZE40-9413	Blue
ZE40-9412	Red	ZE40-9098	Replacement nylon sleeve 180°



ZETA ROTATING BAR CLAMP HS

- Universal hot starter lever with rotating bar clamp.
- Bolts on to your existing brake master cylinder or clutch perch.
- Re-locates the stock hot start lever over to the right or left side perch for easy access.
- Includes nylon sleeve to insert between the clamp and your bar allowing the lever perch to rotate upon impact.

Part number	Color	Part number	Color
ZE40-9211	Titanium	ZE40-9098	Replacement nylon sleeve 180°
ZE40-9212	Red		
ZE40-9213	Blue		

ZETA GRIP PADS

- Made of Neoprene rubber, installed at base of grips.
- Prevents blisters on your thumbs.

Part number	Color
ZE49-9301	Black / White
ZE49-9303	Black / Red



ZETA KILL SWITCH

- Engine kill switch with bar clamp, bolt on to clutch Perch.
- Saves space on your handlebar.
- Bar clamp body is made of aluminum with titanium-color anodized finish.
- Comes with plug type terminals for installation.
- Made of A7009-T6 aluminum CNC machined.

Part number	Description
ZE51-1201	YZ / YZF ('08) , KX / KXF , RM-Z



CONTROL

BARCLAMP

LEVER

FOOT PARTS

HAND GUARD

BODY GUARD

BODY

ACCESSORIES

CARBON



Bar Rise Kit 7/8 in (28.6 mm)
H 19 mm



Bar Rise Kit 7/8 in (22.2 mm)
H 30 mm

Bar rise kit dimension

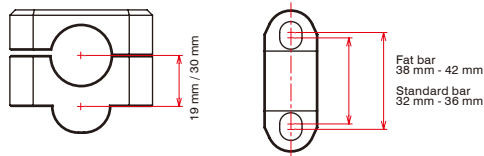

Bar Rise Kit Offset 7/8 in (22.2 mm)
H 26 mm

400X



KX85/100



H : 19 mm

H : 30 mm

ZETA

BAR RISE KIT 1 1/8 in (28.6 mm)

- Universal bar riser kit for over sized (28.6 mm, 1 1/8") bar mount.
- Provides 19 mm and 30 mm higher bar position than stock bar position.
- For use on dirt bikes and ATVs.
- Comes with bar clamp bolts.
- Made of A7009-T6 aluminum.

Part number	Size
ZE53-0219	H: 19 mm
ZE53-0230	H: 30 mm



H : 19 mm

H : 30 mm

ZETA

BAR RISE KIT 7/8 in (22.2 mm)

- Universal bar riser kit for standard sized (22.2 mm, 7/8") bar mount.
- Provides 19 mm and 30 mm higher bar position than stock bar position.
- For use on dirt bikes and ATVs.
- Comes with bar clamp bolts.
- Made of A7009-T6 aluminum.

Part number	Size
ZE53-0119	H: 19 mm
ZE53-0130	H: 30 mm



ZETA

BAR RISE KIT OFFSET 7/8 in (22.2 mm)

- Handlebar rise and offset kit.
- Provides 26 mm higher, 20 mm back and forth positions from stock handlebar position.
- Great to use for 85 / 150 cc tall rider with 20 mm forward position.
- Can be used with 22.2 mm OE bar clamp models with bar clamp width in between 32 mm to 36 mm.

Part number
ZE53-0526

Bar rise kit offset dimension

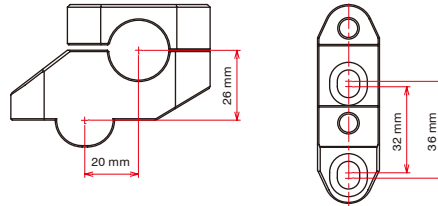

HANDLEBAR CLAMP KIT

- Adjustment system to fit each rider's size, style and type of riding .
- The innovative adjusting system gives you the option of 8 different " back and forth " positions . (Maximum)
- The optional lower clamp enables a total of 4 different heights .
- Provides 32 different positions to fit anyone's needs . (Maximum)
- Made of CNC machined A7009-T6 aluminum.
- Available for SX over-sized bars and Comp standard-sized bars as well .



CRF250R/450R
ZE11-1125



CRF250R/450R
ZE11-1124



Specially designed lower bar clamp provides the option of 8 different back and forth positions in 5 mm increments. (Maximum)



One piece stabilizer is set by 4 special bolts. To securely mount handlebar, the clamp is designed to be tightened first with the 2 front side bolts, then the 2 rear side bolts.



Reinforcing ribs are positioned for maximized strength and minimized weight.



The one-piece upper bar clamp helps stabilize handlebar and prevents bar twist when falling down.



The two holes allow 2 back and forth positions of the handlebar clamp on the top clamp. Utilizing the optional lower clamp enables different handlebar height positions.



Front fork clamp area designed to securely clamp the front fork. Specially designed Front fork bolts are made of stainless to prevent corrosion.

CONTROL

BARCLAMP

LEVER

FOOT PARTS

HAND GUARD

BODY GUARD

BODY

ACCESSORIES

CARBON

Bike (Competition)	Year	Part #		Bar Clamp Size(mm)			
		SX	COMP	Upper	Lower		
HONDA	CR85R	03-07	ZE11-1081	ZE12-1081	80	50	
	CRF150R	07-17	ZE11-1081	ZE12-1081	80	50	
	CR125R/250R	00-07	ZE11-1122	ZE12-1122	90	35	
	CRF250R	04-07	ZE11-1122	ZE12-1122	90	35	
		08-09	ZE11-1123	ZE12-1123	90	35	
		10-17	ZE11-1124	-	90	35	
	CRF250R(Red body)	10-17	ZE11-1125	-	90	35	
	CRF450R	02-07	ZE11-1122	ZE12-1122	90	35	
		08	ZE11-1123	ZE12-1123	90	35	
		09-16	ZE11-1124	-	90	35	
		09-16	ZE11-1125	-	90	35	
		CRF450R(Red Body)	00-08	ZE11-1101	ZE12-1101	80	35
		XR100R/CRF100F	06-17	ZE11-4124	ZE12-4124	90	35
		CRF125F(Red Body)	14-17	ZE11-1102	ZE12-1102	80	35
	CRF230F	03-15	ZE11-1235	ZE12-1235	90	35	
YAMAHA	YZ80/85	93-17	ZE11-4081	ZE12-4081	80	50	
	YZ125/250	06-17	ZE11-4124	ZE12-4124	90	35	
	YZ125X	17	ZE11-4124	ZE12-4124	90	35	
	YZ250X	16-17	ZE11-4124	ZE12-4124	90	35	
	YZ250F	06-08	ZE11-4124	ZE12-4124	90	35	
	YZ450F	09-11	ZE11-4127	-	90	40	
		06-08	ZE11-4124	ZE12-4124	90	35	
		09	ZE11-4127	-	90	40	
		05	ZE11-4123	ZE12-4123	90	35	
		06	ZE11-4125	ZE12-4125	90	35	
KAWASAKI	WR250F	07-14	ZE11-4126	ZE12-4126	90	35	
	WR450F	07-14	ZE11-4126	ZE12-4126	90	35	
		05	ZE11-4123	ZE12-4123	90	35	
		06	ZE11-4125	ZE12-4125	90	35	
SUZUKI	KX80/85/100	98-17	ZE11-2081	ZE12-2081	80	50	
	KX250F	06-08	ZE11-2125	ZE12-2125	90	35	
	KX450F	09-10	ZE11-2129	-	90	35	
		06-08	ZE11-2126	ZE12-2126	90	35	
KTM	RM85	02-16	ZE11-3081	ZE12-3081	80	50	
	RM125	05-08	ZE11-3122	ZE12-3122	90	40	
	RM250	04-08	ZE11-3122	ZE12-3122	90	40	
	RMZ250	07-15	ZE11-3123	ZE12-3123	90	40	
	RMZ450	05-09	ZE11-3123	ZE12-3123	90	40	
125-530EXC /EXC-F/EXC-R	03-08	ZE11-5121	ZE12-5121	90	35		

Handlebar clamp kit (Dual Sports)	Year	Part #		Bar Clamp Size(mm)		
		SX	COMP	Upper	Lower	
HONDA	CRF250L (Red Body)	12-16	ZE11-1255	ZE12-1255	90	35
	XR50/100 MOTARD	05-07	-	ZE12-1053	80	35
	XR250/MOTARD	03-07	ZE11-1252	ZE12-1252	90	35
	XR400 MOTARD	05-08	ZE11-1252	ZE12-1252	90	35
	CRM250R/AR	94-98	ZE11-1252	ZE12-1252	90	35
YAMAHA	TRICKER	04-16	ZE11-4232	ZE12-4232	80	35
	SEROW250	05-16	-	ZE12-4233	80	35
	XT250X	06-16	-	ZE12-4233	80	35
KAWASAKI	WR250R/X (Blue body)	07-17	ZE11-4252	ZE12-4252	90	35
	KLX250/ D-TRACKER	98-07	ZE11-2253	ZE12-2253	90	35
SUZUKI	DRZ400SM	08-16	ZE11-2254	ZE12-2254	90	35
	250SB	02-06	ZE11-2253	ZE12-2253	90	35
	DRZ400SM (Black Body)	04-16	ZE11-3402	ZE12-3402	90	40

Handlebar clamp kit (Mini Moto)	Year	Part #	Bar Clamp Size(mm)		
		COMP	Upper	Lower	
HONDA	CRF50F	04-17	ZE12-1052	-	-
YAMAHA	TT-R50E	06-15	ZE12-4051	-	-
KAWASAKI	KLX110/L	02-17	ZE12-2101	80	35
SUZUKI	DRZ50/70	08-15	ZE12-3051	-	-



CRF125F(SX)
ZE11-1102

CRF125F(COMP)
ZE12-1102



ZETA TRIPLE CLAMP KIT

- Complete triple clamp kits for CRF250L, WR250R/X and DRZ400SM.
- Clamp body is made of CNC machined durable aluminum with beautiful anodized finish.
- Comes with upper and lower clamps, stem shaft, stem nuts and SX bar size (28.6 mm) clamp.

Part number	Bike	Color
ZE14-1255	CRF250L	Red
ZE14-3403	DRZ400SM	Black
ZE14-4252	WR250R/X	Blue
ZE14-4253	WR250X (3 mm offset)	Black

CAUTION

- This kit does not come with stem bearings.
- OE lower clamp bearing, dust seal and 2 of main switch mount bolts may be required for installing this top triple clamp kit.
- Press fit machine or special bearing installation tool would be required for lower clamp bearing installation.



CONTROL

BARCLAMP

LEVER

FOOT PARTS

HAND GUARD

BODY GUARD

BODY

ACCESSORIES

CARBON



WR250X 3mm OFFSET CLAMP

3mm front fork offset clamp increases trail amount, provides quicker and more stable handling for super moto riding.

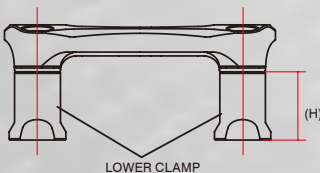

LOWER CLAMP



H 50 mm SX

H 35 mm SX

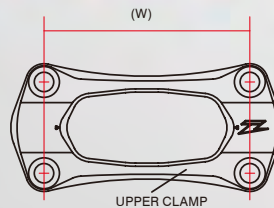

UPPER CLAMP



80 mm

90 mm

ZETA OPTION LOWER CLAMP

- Optional lower clamps for adjusting the height of handlebar.
- Available in 4 different heights.
- Set-ups range from 35 mm to 65 mm in 10 mm increments.

SX (For 28.6mm/1 1/8" bars)

Part number	Height
ZE31-4235	35 mm (1.2")
ZE31-4240	40 mm (1.6")
ZE31-4250	50 mm (2.0")
ZE31-4265	65 mm (2.6")

COMP (For 22.2mm/ 7/8" bars)

Part number	Height
ZE31-4135	35 mm (1.2")
ZE31-4140	40 mm (1.6")
ZE31-4150	50 mm (2.0")
ZE31-4165	65 mm (2.6")

ZETA OPTION UPPER CLAMP

- Replacement stabilizer for ZETA handlebar clamp kit.
- Use with optional lower bar clamp when changing bar size.

SX (For 28.6 mm / 1 1/8" bars)

Part number	Wide
ZE31-3180	80 mm (3.2")
ZE31-3190	90 mm (3.5")

COMP (For 22.2 mm / 7/8" bars)

Part number	Wide
ZE31-2180	80 mm (3.2")
ZE31-2190	90 mm (3.5")



ZE32-4011

ZETA
RX CLAMP KIT

- Designed for easy installation of over-sized bars (1 1/8") to stock rubber-mounted top clamp.
- Accepts 28.6 mm (1 1/8") handlebars with OEM triple clamps.
- The one-piece top bar mount helps stabilize rubber-mounted bars.
- Made of CNC machined A7009-T6 aluminum.

	Bike	Year	Part #
HONDA	CR125R	00-07	ZE32-4011
	CR250R	99-07	
	CRF250R/X	04-17	
	CRF450R	02-17	
	CRF450RX	17	
YAMAHA	WR250R/X	05-16	ZE32-4045
	WR250R/X	07-17	
KAWASAKI	KX125	06-08	ZE32-4051
	KX250	05-08	
	KX250F	05-12	
	KX250F*	15-17	
SUZUKI	KX450F*	06-17	ZE32-4051
	RMZ250	05-06	

*12-17 model can set only near side.



CRF450R



CONTROL

BARCLAMP

LEVER

FOOT PARTS

HAND GUARD

BODY GUARD

BODY

ACCESSORIES

CARBON



ZE32-4201

ZE32-4245

ZETA
RX2 CLAMP KIT

- Two-piece handlebar clamp kit developed for easy installation of over-sized bars (1 1/8") to stock rubber-mounted top clamp.
- Specially designed bolts enable three different back and forth positions (stock , stock + / - 4 mm)
- Available for CR, CRF, KX, KXF and WR250R / X . The height is not adjustable.
- WR250R / X clamp is 10mm higher than stock bar position.

	Bike	Year	Part #
HONDA	CR125R	00-07	ZE32-4201
	CR250R	99-07	
	CRF250R/X	04-17	
	CRF450R	02-17	
	CRF450RX	17	
YAMAHA	WR250R/X #	05-16	ZE32-4245
	WR250R/X #	07-17	
KAWASAKI	KX125	06-08	ZE32-4201
	KX250	05-08	
	KX250F	05-17	
	KX450F	06-17	
SUZUKI	RMZ250	05-06	ZE32-4201

WR250R



ZE37-0311

ZE37-0322

ZE37-0352

ZETA
RUBBER KILLER

- Solid cones for rubber bar mounted stock triple top clamps.
- Provides direct control and prevents bar twist when falling down.
- Finished in anodized red and blue colors.
- Comes in a set of 4 solid cones.
- Made of A7009-T6 aluminum.

	Bike	Color	Part #
HONDA	CR125R'00-, CR250R'99-, CRF250R'04-, CRF450R'02-, CRF450RX'17-	Red	ZE37-0311
KAWASAKI	KX125'02-, KX250'96-, KX250F'04-14, KX450F'06-11	Red	ZE37-0321
	KLX125'10-, KLX150S'09-, D-TRACKER125'10-, RMZ250'04-'06		
SUZUKI	KX250F'15-, KX450F'12-	Blue	ZE37-0322
	RM125'05-, RM250'02-, RMZ250'07-, RMZ450'05-, DRZ400SM'05-	Red	ZE37-0331
YAMAHA	YZ250F'14-, YZ450F'14-, YZ250FX'15-	Blue	ZE37-0341
	YZ450FX'16-, WR250F'15-		
Husqvarna	TC125'16-, TC250'16-, FC250'16-, FC350'16-, FC450'16-	Blue	ZE37-0351
KTM	125SX'16-, 150SX'16-, 250SX'16-	Orange	ZE37-0352
	250SX-F'16-, 350SX-F'16-, 450SX-F'16-		



ZE33-3100

YZ250F

Bike	Year	SX
YAMAHA		
YZ125/250	07-17	ZE33-3100
YZ125X	17	ZE33-3100
	16-17	ZE33-3100
YZ250X	06-08	ZE33-3100
	14-17	ZE33-3103
	06-08	ZE33-3100
YZ400F-450F	14-17	ZE33-3103
YZ250FX	15-17	ZE33-3103
YZ450FX	16-17	ZE33-3103
WR250F	07-09	ZE33-3100
	15-16	ZE33-3103
	07-09	ZE33-3100
WR400F-450F	16	ZE33-3103

Bike	Year	SX
SUZUKI		
RM125	06-08	ZE33-3096
RM250	06-08	ZE33-3096
RMZ250	07-15	ZE33-3096
RMX450	05-17	ZE33-3096
RMX450Z	10-15	ZE33-3096
KTM		
125-450SX/SX-F	10-16	ZE33-3091
150-300XC	10-16	ZE33-3091
250/350XC-F	11-16	ZE33-3091
450XC-F	13-16	ZE33-3091

ZETA

SX STABILIZER 1 1/8 in (28.6 mm)

- The one-piece top bar mount for over sized bars.
- Improves steering control and rigidity.
- Comes with bar clamp bolts.
- Made of CNC machined A7009-T6 aluminum.



ZE33-2085

ZETA

COMP STABILIZER 7/8 in (22.2 mm)

- The one-piece top bar mount for standard size handlebars.
- Improves steering control and rigidity.
- Install with stock handlebar clamp bolts.
- Made of CNC machined A7009-T6 aluminum.

Bike	Year	Comp
HONDA		
CR125R	95-99	ZE33-2100
	00-07	ZE33-2106
CR250R	95-98	ZE33-2100
	99-07	ZE33-2106
CRF250R/X	04-17	ZE33-2106
CRF450R	02-16	ZE33-2106
CRF450X	05-17	ZE33-2106
CRM250R/AR	89-98	ZE33-2100
CRF250L	12-16	ZE33-2100
XLR125R/200R	93-00	ZE33-2100
XLR250/XR250, BAJA	-94	ZE33-2100
XR230	05-12	ZE33-2100
XR250/BAJA/MOTARD	95-07	ZE33-2100
XR250R/400R	96-04	ZE33-2100
XR600R/650R	88-06	ZE33-2100
FTR223, SL230	97-08	ZE33-2100
YAMAHA		
YZ80/85	93-14	ZE33-2085
YZ125/250	90-06	ZE33-2100
YZ250F	01-05	ZE33-2100
YZ400F-450F	98-05	ZE33-2100
WR250F	99-06	ZE33-2100
WR400F-450F	99-06	ZE33-2100
TTR125	00-04	ZE33-2085
TTR250R/RAID	93-07	ZE33-2100
DT125/200	88-92	ZE33-2100
DT200WR	91-96	ZE33-2100
DT230 LANZA	97-98	ZE33-2085
TW200	91-04	ZE33-2085
SEROW225WE/250, XT225	93-16	ZE33-2085
TRICKER	04-16	ZE33-2085
XT250X	06-16	ZE33-2085
WR250R/X	07-17	ZE33-2100

Bike	Year	Comp
KAWASAKI		
KX60/65	94-17	ZE33-2085
KX80/85/100	96-17	ZE33-2085
KX125	96-05	ZE33-2090
	06-08	ZE33-2098
KX250	92-04	ZE33-2090
	05-08	ZE33-2098
KX250F	04	ZE33-2090
	05-12	ZE33-2098
KX450F*	06-16	ZE33-2098
KDX125-250	88-99	ZE33-2090
KLX250/D-TRACKER	98-16	ZE33-2090
SUZUKI		
RM125	96-05	ZE33-2098
	96-00	ZE33-2098
RM250	01	ZE33-2100
	02-05	ZE33-2098
	04	ZE33-2090
RMZ250	05-06	ZE33-2098
DRZ250, DR250R, DJEBEL 250XC	95-07	ZE33-2100
DRZ400S/R/SM	00-16	ZE33-2098
TS125R/200R		ZE33-2100
SX/DR/DF125/200		ZE33-2100
RMX250S/R	96-98	ZE33-2100
250SB	02-06	ZE33-2090

* 2012-2017 model can set only near side.



ZETA

UX3 CLAMP KIT

- Adapts stock 22.2 mm (7/8") bar mounts to accept 28.6 mm (1 1/8") handlebars.
- Adds 20 mm (4/5") to bar height. Please take this into consideration when selecting bars.

Part number
ZE32-1200

CRF450R

CONTROL

BARCLAMP

LEVER

FOOT PARTS

HAND GUARD

BODY GUARD

BODY

ACCESSORIES

CARBON

PMOT
L E V E R
FORGED LEVER ARM **FP**

ZETA
PIVOT LEVER FP

- Original pivot lever design, in a durable forged lever body.
- Lever arm holder and lever body M type designed for racing use.
- Laser printed ZETA logo on the front of the lever.
- Titanium anodized finish.



Replacement parts



Mount Kit	Clutch Lever Arm	Brake Lever Arm
ZE41-0190 Brake	ZE42-3600 3 Finger	ZE41-3600 3 Finger
ZE42-0190 Clutch	ZE42-4600 4 Finger	

PIVOT LEVER FP
Forged lever arm

Smooth surface forged lever arm with laser printed logo.

CONTROL

BARCLAMP

LEVER

FOOT PARTS

HAND GUARD

BODY GUARD

BODY

ACCESSORIES

CARBON

PMOT
L E V E R
CNC MACHINED **CP**

ZETA
PIVOT LEVER CP

- CNC Machined aluminum folding levers.
- The pivot design allows the lever to fold outward to prevent bending or breaking in the event of a crash.
- Hard anodized finish, made of CNC machined aircraft grade aluminum.
- M-type rectilinear lever available for more competitive use.
- Exclusively designed for each bike, available 3 and 4 finger lever lengths.



Replacement parts



Mount Kit	Brake Lever Arm K-Type	Brake Lever Arm M-Type
ZE41-0190 Brake	ZE41-3100 3 Finger	ZE41-3200 3 Finger
ZE42-0190 Clutch	ZE41-4100 4 Finger	ZE41-4200 4 Finger
	Clutch Lever Arm K-Type	Clutch Lever Arm M-Type
	ZE42-3100 3 Finger	ZE42-3200 3 Finger
	ZE42-4100 4 Finger	ZE42-4200 4 Finger



PIVOT LEVER CP
PIVOT LEVER FP

Pivot

Pivot design with return spring allows the lever to fold outward to prevent bending or breaking.

Adjustable

Adjustable reach system provides the perfect lever position for all riders.

CNC Machined lever arm

Machined ZETA logo provides better lever grip.

K Type
For street bikes with switch boxes on the handlebar.

M Type
For racing bikes without switch boxes on the handlebar.

PIVOT LEVER CP and FP BRAKE	Year	Pivot CP			Pivot FP	
		4 Finger	3 Finger	Type	4 Finger	3 Finger
HONDA	CR80R/85R	98-07	-	ZE41-3206	M	ZE41-3606
	CRF150R	07-17	-	ZE41-3206	M	ZE41-3606
	CR125R/250R	92-07	-	ZE41-3206	M	ZE41-3606
	CRF250R	04-06	-	ZE41-3206	M	ZE41-3606
	CRF250R	07-17	-	ZE41-3207	M	ZE41-3607
	CRF450R	02-06	-	ZE41-3206	M	ZE41-3606
	CRF450R	07-17	-	ZE41-3207	M	ZE41-3607
	CRF250X	04-17	-	ZE41-3206	M	ZE41-3606
	CRF450X	05-17	-	ZE41-3206	M	ZE41-3606
	CRF125F	14-17	-	ZE41-3206	M	ZE41-3606
	CRF150F/230F	03-17	-	ZE41-3206	M	ZE41-3606
	SL230	97-04	ZE41-4105	ZE41-3105	K	-
	XR230/MOTARD	05-12	ZE41-4105	ZE41-3105	K	-
	XR250/MOTARD	95-07	ZE41-4105	ZE41-3105	K	-
	CRM250R/AR	94-99	ZE41-4105	ZE41-3105	K	-
	XR400MOTARD	05-08	ZE41-4105	ZE41-3105	K	-
CRF250L/M	12-16	ZE41-4144	ZE41-3145	K	-	
CRF1000L	16	ZE41-4298	-	M	-	
YZ80/85	01-17	-	ZE41-3262	M	ZE41-3662	
YZ125/250	01-07	-	ZE41-3262	M	ZE41-3662	
YZ250F	08-17	-	ZE41-3265	M	ZE41-3665	
YZ250F	01-06	-	ZE41-3262	M	ZE41-3662	
YZ250F	07-17	-	ZE41-3265	M	ZE41-3665	
YZ426F/450F	01-07	-	ZE41-3262	M	ZE41-3662	
YZ426F	08-17	-	ZE41-3265	M	ZE41-3665	
YZ125X	18-17	-	ZE41-3265	M	ZE41-3665	
YZ250X	16-17	-	ZE41-3265	M	ZE41-3665	
YZ250FX	15-17	-	ZE41-3265	M	ZE41-3665	
YZ450FX	16-17	-	ZE41-3265	M	ZE41-3665	
WR250F	01-16	-	ZE41-3262	M	ZE41-3662	
WR450F	01-15	-	ZE41-3262	M	ZE41-3662	
WR250R/X	16	-	ZE41-3265	M	ZE41-3665	
SEROW225/250	07-17	ZE41-4161	ZE41-3161	K	-	
TTR250	86-16	ZE41-4161	ZE41-3161	K	-	
TTR600	93-	ZE41-4161	ZE41-3161	K	-	
XT250X	98	ZE41-4264	-	M	-	
TRICKER	04-16	ZE41-4161	ZE41-3161	K	-	
DT230LANZA	97-	ZE41-4161	ZE41-3161	K	-	
YF2450	07-10	ZE41-4298	-	M	-	
KAWASAKI	KX65	00-17	-	ZE41-3262	M	ZE41-3662
	KX85/100	01-17	-	ZE41-3262	M	ZE41-3662
	KX125/250	00-08	-	ZE41-3262	M	ZE41-3662
	KX250/450F	04-12	-	ZE41-3262	M	ZE41-3662
	KX250/450F	13-17	-	ZE41-3265	M	ZE41-3665
	KLX125,D-TRACKER125	10-16	ZE41-4145	ZE41-3145	K	-
	KLX150S	00-13	ZE41-4145	ZE41-3145	K	-
	KLX250,D-TRACKER	93-07	ZE41-4144	ZE41-3144	K	-
	KLX450R	08-16	ZE41-4145	ZE41-3145	K	-
	KDX125SR	08-09	-	ZE41-3262	M	ZE41-3662
	KDX250SR	90-	ZE41-4145	ZE41-3145	K	-
	KDX250SR	92-94	ZE41-4144	ZE41-3144	K	-
	KFX450R	08-10	ZE41-4293	-	M	-

PIVOT LEVER CP and FP BRAKE	Year	Pivot CP			Pivot FP	
		4 Finger	3 Finger	Type	4 Finger	3 Finger
SUZUKI	RM85	05-16	-	ZE41-3262	M	ZE41-3662
	RM125/250	96-03	-	ZE41-3206	M	ZE41-3606
	RMZ250	04-08	-	ZE41-3262	M	ZE41-3662
	RMZ450	04-17	-	ZE41-3262	M	ZE41-3662
	RMX450Z	04-17	-	ZE41-3262	M	ZE41-3662
	RMX250S	10-16	-	ZE41-3262	M	ZE41-3662
	RMX250S	93-95	ZE41-4144	ZE41-3144	K	-
	DR2400S/SM	00-16	ZE41-4142	ZE41-3142	K	-
	DR250R	96-00	ZE41-4142	ZE41-3142	K	-
	DR250S	90-94	ZE41-4144	ZE41-3144	K	-
	250SB	02-06	ZE41-4144	ZE41-3144	K	-
	LTZ400/450	06-09	ZE41-4295	-	M	-
	65SX/XC	04-11	-	ZE41-3282	M	ZE41-3682
	85/150SX/XC	14-16	-	Under development	-	-
	125SX/XC-W/EXC(SIX DAYS)	03-11	-	ZE41-3282	M	ZE41-3682
	144/150SX/150XC/150XC-W	13-17	-	Under development	-	-
200XC-W/EXC	05-13	-	ZE41-3281	M	ZE41-3681	
250SX/SX-F/XC/XC-F	14-17	-	ZE41-3283	M	ZE41-3683	
250XC-W/XCF-W	14-17	-	ZE41-3283	M	ZE41-3683	
250XC/EXC-R/EXC-F(SIX DAYS)	11-13	-	ZE41-3281	M	ZE41-3681	
300XC/XC-W/EXC(SIX DAYS)	14-17	-	ZE41-3283	M	ZE41-3683	
350SX-F/XC-F/XCF-W	05-11	-	ZE41-3281	M	ZE41-3681	
350XC-F(SIX DAYS)	05-13	-	ZE41-3281	M	ZE41-3681	
400XC-W/EXC/EXC-R	12-13	-	ZE41-3281	M	ZE41-3681	
450SX/SX-R/SX-F	14-17	-	ZE41-3283	M	ZE41-3683	
450XC/XC-F/XCF-W, XC-W	12-13	-	ZE41-3281	M	ZE41-3681	
450XC-R/EXC/EXC-F(SIX DAYS)	14-17	-	ZE41-3283	M	ZE41-3683	
500XC-W/EXC/EXC-F(SIX DAYS)	08-09	-	ZE41-3281	M	ZE41-3681	
505SX-F/XC-F	05-07	-	ZE41-3281	M	ZE41-3681	
525SX/SX-R/XC/XC-W/EXC-R	08-11	-	ZE41-3281	M	ZE41-3681	
530XC-W/XCF-W/EXC-R/EXC	07-09	-	ZE41-3271	M	-	
450SMR	13	-	ZE41-3281	M	ZE41-3681	
FREERIDE 250R	14-17	-	Under development	-	-	
FREERIDE 350	12-17	-	Under development	-	-	
Husqvarna	TC/TE/WR125-511	-13	-	ZE41-3281	M	ZE41-3681
	TC85	14-17	-	Under development	-	-
	TC/TE/XT125-300	14-17	-	ZE41-3283	M	ZE41-3683
	TC/TE/FX250-501	14-17	-	ZE41-3283	M	ZE41-3683
BETA	RR 2T	13-17	-	ZE41-3206	M	ZE41-3606
	RR/RS 4T	08-16	-	ZE41-3206	M	ZE41-3606
GASGAS	X-Trainee	15-17	-	ZE41-3206	M	ZE41-3606
	EC 2T	00-17	-	ZE41-3206	M	ZE41-3606
TRIAL	EC 4T	10-15	-	ZE41-3206	M	ZE41-3606
	FSE/FSR	03-09	-	ZE41-3206	M	ZE41-3606
MOTARD	AJP	-	-	ZE41-3185	K	-
	BREMBO RADIAL SHORT	-	-	ZE41-3275	M	-
MAJURA 195.5 SHORT	-	-	ZE41-3271	M	-	
NISSIN RS-TYPE	-	-	ZE41-4299	M	-	

PIVOT LEVER CP and FP CLUTCH	Year	Pivot CP			Pivot FP	
		4 Finger	3 Finger	Type	4 Finger	3 Finger
HONDA	CR80R/85R	83-07	ZE42-4101	ZE42-3101	K	-
	CRF150R	07-17	ZE42-4101	ZE42-3101	K	-
	CR125R/250R	92-03	ZE42-4101	ZE42-3101	K	-
	CRF250R	04-07	ZE42-4210	ZE42-3210	M	ZE42-4610 ZE42-3610
	CRF250R	04-17	ZE42-4210	ZE42-3210	M	ZE42-4610 ZE42-3610
	CRF450R	02-03	ZE42-4101	ZE42-3101	K	-
	CRF450R	04-17	ZE42-4210	ZE42-3210	M	ZE42-4610 ZE42-3610
	CRF250X	04-17	ZE42-4210	ZE42-3210	M	ZE42-4610 ZE42-3610
	CRF450X	05-17	ZE42-4210	ZE42-3210	M	ZE42-4610 ZE42-3610
	CRF230F	03-09	ZE42-4103	ZE42-3103	K	-
	CRF250L/M	12-16	ZE42-4104	ZE42-3104	K	-
	CRF1000L	16	ZE42-4105	-	K	-
	SL230	97-04	ZE42-4103	ZE42-3103	K	-
	XR230/MOTARD	05-12	ZE42-4103	ZE42-3103	K	-
	XR250/MOTARD	95-07	ZE42-4101	ZE42-3101	K	-
	XR400MOTARD	05-08	ZE42-4101	ZE42-3101	K	-
CRM250R/AR	94-98	ZE42-4101	ZE42-3101	K	-	
XR650R	00-06	ZE42-4101	ZE42-3101	K	-	
YZ80/85	95-14	ZE42-4160	ZE42-3160	K	-	
YZ125/250	15-17	ZE42-4266	ZE42-3266	M	ZE42-4666 ZE42-3666	
YZ250F	00-14	ZE42-4261	ZE42-3261	M	ZE42-4661 ZE42-3661	
YZ250F	15-17	ZE42-4266	ZE42-3266	M	ZE42-4666 ZE42-3666	
YZ250F	00-08	ZE42-4261	ZE42-3261	M	ZE42-4661 ZE42-3661	
YZ426F/450F	09-17	ZE42-4266	ZE42-3266	M	ZE42-4666 ZE42-3666	
YZ125X	18-17	ZE42-4266	ZE42-3266	M	ZE42-4666 ZE42-3666	
YZ250X	16-17	ZE42-4266	ZE42-3266	M	ZE42-4666 ZE42-3666	
YZ250FX	15-17	ZE42-4267	ZE42-3267	M	ZE42-4667 ZE42-3667	
YZ450FX	16-17	ZE42-4267	ZE42-3267	M	ZE42-4667 ZE42-3667	
WR250F	05-16	ZE42-4165	ZE42-3165	K	-	
WR450F	05-16	ZE42-4165	ZE42-3165	K	-	
WR250R/X	07-17	ZE42-4160	ZE42-3160	K	-	
SEROW225/250	86-16	ZE42-4160	ZE42-3160	K	-	
TTR125/LW/E	00-08	ZE42-4160	ZE42-3160	K	-	
TTR250	93-97	ZE42-4160	ZE42-3160	K	-	
TTR600	98-02	ZE42-4182	-	K	-	
XT250X	08-16	ZE42-4160	ZE42-3160	K	-	
TRICKER	04-16	ZE42-4160	ZE42-3160	K	-	
DT230LANZA	97-99	ZE42-4160	ZE42-3160	K	-	
KAWASAKI	KX65	00-17	ZE42-4220	ZE42-3220	M	ZE42-4620 ZE42-3620
	KX80/85	98-17	ZE42-4220	ZE42-3220	M	ZE42-4620 ZE42-3620
	KX125	90-05	ZE42-4220	ZE42-3220	M	ZE42-4620 ZE42-3620
	KX250	06-08	ZE42-4261	ZE42-3261	M	ZE42-4661 ZE42-3661
	KX250	90-04	ZE42-4220	ZE42-3220	M	ZE42-4620 ZE42-3620
	KX250F	05-08	ZE42-4261	ZE42-3261	M	ZE42-4661 ZE42-3661
	KX450R	04	ZE42-4220	ZE42-3220	M	ZE42-4620 ZE42-3620
	KX125-250	05-17	ZE42-4261	ZE42-3261	M	ZE42-4661 ZE42-3661
	KLX450R	08-15	ZE42-4165	ZE42-3165	K	-
	KDX125-250	86-99	ZE42-4160	ZE42-3160	K	-
	KLX125,D-TRACKER125	10-16	ZE42-4127	ZE42-3127	K	-
	KLX150S	09-13	ZE42-4127	ZE42-3127	K	-
	KLX250,D-TRACKER	93-97	ZE42-4160	ZE42-3160	K	-
	TTR600	98-02	ZE42-4182	-	K	-
	XT250X	08-16	ZE42-4160	ZE42-3160	K	-
	SUPER SHERPA	97-07	ZE42-4125	ZE42-3125	K	-
SUZUKI	RM85	05-16	ZE42-4160	ZE42-3160	K	-
	RM125/250	92-08	ZE42-4160	ZE42-3160	K	-
	RMZ250	04	ZE42-4220	ZE42-3220	M	ZE42-4620 ZE42-3620
	RMZ450	05-06	ZE42-4261	ZE42-3261	M	ZE42-4661 ZE42-3661
	RMZ450	07-17	ZE42-4220	ZE42-3220	M	ZE42-4620 ZE42-3620
	RMX250R/S	05-17	ZE42-4220	ZE42-3220	M	ZE42-4620 ZE42-3620
	RMX250R/S	93-98	ZE42-4160	ZE42-3160	K	-
	DR2400S/SM	00-04	ZE42-4140	ZE42-3140	K	-
	DR250R	00-16	ZE42-4140	ZE42-3140	K	-
	DR250S	97-00	ZE42-4140	ZE42-3140	K	-
	DJEBEL250XC	98-06	ZE42-4140	ZE42-3140	K	-
	250SB	02-06	ZE42-4125	ZE42-3125	K	-

PIVOT LEVER CP and FP CLUTCH	Year	Pivot CP			Pivot FP		
		4 Finger	3 Finger	Type	4 Finger	3 Finger	
SUZUKI	65SX/XC	04-13	#1	ZE42-4182	ZE42-3182	K	-
	65SX/XC	14-16	#4	-	Under development	-	-
	85SX/XC	03-12	#1	ZE42-4182	ZE42-3182	K	-
	105SX/XC	13-17	#4	-	Under development	-	-
	105SX/XC	07-11	#1	ZE42-4182	ZE42-3182	K	-
	125XC(SIX DAYS)	04-08	#1	ZE42-4182	ZE42-3182	K	-
	125SX/XC-W/144SX	09-16	#2	ZE42-4284	ZE42-3284	M	ZE42-4684 ZE42-3684
	150SX/XC/XC-W	05-08	#1	ZE4			



4 Finger
Titanium / Blue



3 Finger
Titanium / Red

ZETA PIVOT PERCH CP

- High quality CNC machined rotating clutch perch with Pivot Lever CP Clutch K-Type.
- Clutch perch is made of CNC machined A7009 aluminum. Lever is made of CNC machined aluminum for durable construction.
- Provides 2 different lever ratios, light pulling and accurate clutch control by changing position of Ratio Device (**PATENT PENDING**).
- Best to use with PIVOT LEVER CP BRAKE.
- 3 finger and 4 finger lever arm models are available.
- Clutch wire adjuster available in blue and red colors.
- Optional hot starter lever is available.



Cp K-Type lever is designed to avoid interference with switch assembly.

Part number	Description
ZE43-1310	3 Finger Titanium / Red
ZE43-1311	3 Finger Titanium / Blue
ZE43-1410	4 Finger Titanium / Red
ZE43-1411	4 Finger Titanium / Blue

Optional parts

	Part number ZE43-9080	Description Hot Starter lever Red
---	---	---

Pivot Perch CP Replacement parts

	Lever Arm K-Type ZE42-3100 3 Finger ZE42-4100 4 Finger		Adjuster Assy ZE43-9393 Red ZE43-9394 Blue		Adapter Assy ZE43-9289		Perch Assy ZE43-9396		Dust cover ZE43-9292		Bolt set ZE43-9399
---	---	---	---	--	--	---	--	---	--	---	--

PIVOT PERCH CP & FP FUNCTION

Ratio Device

PATENT PENDING

ACCURATE RATIO

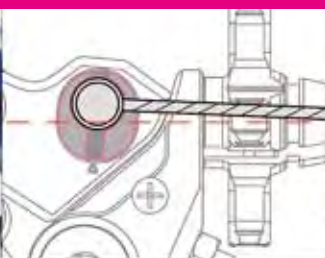

LIGHT RATIO

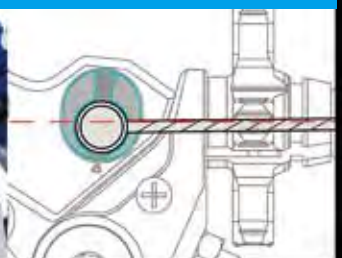

Provides 2 different lever ratios, light pulling and accurate clutch control, by changing position of Ratio Device.



4 Finger
Titanium / Blue

3 Finger
Titanium / Red

ZETA
PIVOT PERCH FP

- High quality CNC machined rotating clutch perch with PIVOT LEVER FP CLUTCH.
- Clutch perch is made of CNC machined A7009 aluminum. Lever arm is made of forged aluminum for durable construction, more competitive use for MX or ED.
- Provides 2 different lever ratios, light pulling and accurate clutch control, by changing position of Ratio Device (*PATENT PENDING*).
- Best to use with PIVOT LEVER FP BRAKE.
- 3 finger and 4 finger lever arm models are available.
- Clutch wire adjuster available in red and blue colors.
- Optional hot starter lever is available.

Part number	Description
ZE43-2310	3 Finger Titanium / Red
ZE43-2311	3 Finger Titanium / Blue
ZE43-2410	4 Finger Titanium / Red
ZE43-2411	4 Finger Titanium / Blue

< Caution > Can not be used if lever interferes with switch box on your handlebar.



Optional parts

PIVOT PERCH FP Replacement parts



Part number [ZE43-9080](#)
Description Hot Starter lever Red



Lever Arm
[ZE42-3600](#) 3 Finger
[ZE42-4600](#) 4 Finger



Adjuster Assy
[ZE43-9393](#) Red
[ZE43-9394](#) Blue



Adapter Assy
[ZE43-9389](#)



Perch Assy
[ZE43-9396](#)



Dust cover
[ZE43-9392](#)



Bolt set
[ZE43-9399](#)

Adjust bolt & Quick cable adjuster

Quick clamp system & Nylon Sleeve

Flex outward



- Quick and easy to adjust clutch play even during the ride.
- Provides the best lever position for any hand size.

- Hinge style clamp for easy and quick maintenance.
- Nylon sleeve placed between the clamp and handlebar allows the perch to rotate upon impact.

- Built-in return spring in the Pivot lever allows the lever to swing forward in the event of crash and prevents lever breakage.

CONTROL

BARCLAMP

LEVER

FOOT PARTS

HAND GUARD

BODY GUARD

BODY

ACCESSORIES

CARBON

ZETA

PIVOT LEVER SET FP

- Pivot FP clutch and brake lever set for MX racing models.
- Comes with durable forged color anodized lever arm.
- Lever folds outward to prevent breakage in the event of a crash.
- Lever adapter is ultraprecise CNC machined out of high grade aluminum for super light weight design.
- Available red, blue, orange and black colors for specific models.
- Function consistent with style.

Bike	Year	Black	Blue	Red
HONDA				
CRF250R	07-17	ZE44-0101	-	ZE44-0103
CRF450R	07-17	ZE44-0101	-	ZE44-0103
CRF450RX	17	ZE44-0101	-	ZE44-0103
YAMAHA				
YZ125/250	01-07	ZE44-1101	ZE44-1102	ZE44-1103
	08-14	ZE44-1111	ZE44-1112	ZE44-1113
	15-17	ZE44-1101	ZE44-1102	-
	01-06	ZE44-1101	ZE44-1102	ZE44-1103
YZ250F	07-08	ZE44-1111	ZE44-1112	ZE44-1113
	09-17	ZE44-3101	ZE44-3102	-
YZ426F/450F	01-07	ZE44-1101	ZE44-1102	ZE44-1103
	08	ZE44-1111	ZE44-1112	ZE44-1113
	09-17	ZE44-3101	ZE44-3102	-
YZ125X	17	ZE44-3101	ZE44-3102	-
YZ250X	16-17	ZE44-3101	ZE44-3102	-
YZ250FX	15-17	ZE44-3111	ZE44-3112	-
YZ450FX	16-17	ZE44-3111	ZE44-3112	-
KAWASAKI				
KX65	00-17	ZE44-2101	ZE44-2102	ZE44-2103
KX85/100	01-17	ZE44-2101	ZE44-2102	ZE44-2103
	00-05	ZE44-2101	ZE44-2102	ZE44-2103
KX125	06-08	ZE44-1101	ZE44-1102	ZE44-1103
	00-04	ZE44-2101	ZE44-2102	ZE44-2103
KX250	05-08	ZE44-1101	ZE44-1102	ZE44-1103
	04	ZE44-2101	ZE44-2102	ZE44-2103
KX250F	05-12	ZE44-1101	ZE44-1102	ZE44-1103
	13-17	ZE44-1111	ZE44-1112	ZE44-1113
KX450F	06-12	ZE44-1101	ZE44-1102	ZE44-1103
	13-17	ZE44-1111	ZE44-1112	ZE44-1113
SUZUKI				
	04	ZE44-2101	ZE44-2102	ZE44-2103
RMZ250	05-06	ZE44-1101	ZE44-1102	ZE44-1103
	07-17	ZE44-2101	ZE44-2102	ZE44-2103
RMZ450	05-17	ZE44-2101	ZE44-2102	ZE44-2103
HUSQVARNA				
TC125	14-17	#4 ZE44-4131	ZE44-4132	-
TC250	14-17	#4 ZE44-4131	ZE44-4132	-
TE125	14-16	#4 ZE44-4131	ZE44-4132	-
TE150	17	#4 ZE44-4131	ZE44-4132	-
TE250/300	14-16	#3 ZE44-4121	ZE44-4122	-
	17	#4 ZE44-4131	ZE44-4132	-
FC250-450	14-15	#3 ZE44-4121	ZE44-4122	-
	16-17	#4 ZE44-4131	ZE44-4132	-
FE250-501/S	14-16	#3 ZE44-4121	ZE44-4122	-
	17	#4 ZE44-4131	ZE44-4132	-
TX125-300	17	#4 ZE44-4131	ZE44-4132	-
FX350-450	17	#4 ZE44-4131	ZE44-4132	-

	Clutch	Brake
#1	Brembo	Brembo-'13
#2	New MAGURA	Brembo-'13
#3	Brembo	Brembo-'14-
#4	New MAGURA	Brembo-'14-

Bike	Year	Black	Orange
KTM			
125EXC (SIX DAYS)	09-13	#2 ZE44-4111	ZE44-4117
	14-16	#4 ZE44-4131	ZE44-4137
	09-13	#2 ZE44-4111	ZE44-4117
125SX/XC-W/144SX	14-15	#4 ZE44-4131	ZE44-4137
	16-17	#3 ZE44-4121	ZE44-4127
	09-13	#2 ZE44-4111	ZE44-4117
150SX/XC/XC-W	14-15	#4 ZE44-4131	ZE44-4137
	16-17	#3 ZE44-4121	ZE44-4127
	09-13	#2 ZE44-4111	ZE44-4117
200XC-W	14-16	#4 ZE44-4131	ZE44-4137
	09-13	#2 ZE44-4111	ZE44-4117
200EXC/XC	14-15	#4 ZE44-4131	ZE44-4137
	16	#3 ZE44-4121	ZE44-4127
250EXC/EXC-F (SIX DAYS)	06-13	#1 ZE44-4101	ZE44-4107
	14-17	#3 ZE44-4121	ZE44-4127
	07-13	#1 ZE44-4101	ZE44-4107
250SX-F	14-17	#3 ZE44-4121	ZE44-4127
250SX	06-13	#1 ZE44-4101	ZE44-4107
	14-17	#3 ZE44-4121	ZE44-4127
250XC	06-13	#1 ZE44-4101	ZE44-4107
	14-17	#3 ZE44-4121	ZE44-4127
250XC-F/XCF-W	07-13	#1 ZE44-4101	ZE44-4107
	14-17	#3 ZE44-4121	ZE44-4127
250/300XC-W	06-13	#1 ZE44-4101	ZE44-4107
	14-17	#3 ZE44-4121	ZE44-4127
300EXC (SIX DAYS)	14-17	#3 ZE44-4121	ZE44-4127
300XC	06-13	#1 ZE44-4101	ZE44-4107
	14-17	#3 ZE44-4121	ZE44-4127
350EXC-F/SIX DAYS	11-13	#1 ZE44-4101	ZE44-4107
350SX-F/XC-F/XCF-W	14-17	#3 ZE44-4121	ZE44-4127
400EXC	09-11	#1 ZE44-4101	ZE44-4107
400XC-W	09-10	#1 ZE44-4101	ZE44-4107
450EXC/R/EXC-F (SIX DAYS)	07-13	#1 ZE44-4101	ZE44-4107
450RALLY REPLICAS	14-17	#3 ZE44-4121	ZE44-4127
	15-16	#3 ZE44-4121	ZE44-4127
	09	#2 ZE44-4111	ZE44-4117
450SMR	13	#1 ZE44-4101	ZE44-4107
	14	#3 ZE44-4121	ZE44-4127
	09-12	#2 ZE44-4111	ZE44-4117
450SX/SX-F/SX-R	13	#1 ZE44-4101	ZE44-4107
	14-17	#3 ZE44-4121	ZE44-4127
450XC-F/EXC/EXC-F	08	#1 ZE44-4101	ZE44-4107
	13	#1 ZE44-4101	ZE44-4107
	14-17	#3 ZE44-4121	ZE44-4127
450XC-W/XCR-W (SIX DAYS)	08-13	#1 ZE44-4101	ZE44-4107
	14-16	#3 ZE44-4121	ZE44-4127
500EXC/EXC-F/XC-W (SIX DAYS)	12-13	#1 ZE44-4101	ZE44-4107
	14-17	#3 ZE44-4121	ZE44-4127
505XC-F	08	#1 ZE44-4101	ZE44-4107
525EXC-R	07	#1 ZE44-4101	ZE44-4107
530EXC-/EXC-R/XCR-W/XC-W (SIX DAYS)	08-11	#1 ZE44-4101	ZE44-4107

Pivot lever FP Replacement

Brake Lever Arm

ZE41-36001	Black	ZE41-36003	Red
ZE41-36002	Blue	ZE41-36007	Orange

Clutch Lever Arm

ZE42-36001	Black	ZE42-36003	Red
ZE42-36002	Blue	ZE42-36007	Orange

ZETA

PIVOT LEVER SET CP

- Pivot CP clutch and brake lever set for Trail models.
- Lever folds outward to prevent breakage in the event of a crash.
- Lever adapter is ultraprecise CNC machined out of high grade aluminum for super light weight design.
- Available red, blue and black colors for specific models.

Bike	Year	Black	Blue	Red	
HONDA	CRF250L/M	12-16	ZE44-5011	-	ZE44-5013
YAMAHA	WR250R/X	07-17	ZE44-8011	ZE44-8012	-
	SEROW225/250	86-16	ZE44-8011	ZE44-8012	-
	TTR250	93-97	ZE44-8011	ZE44-8012	-
	XT250X	06-16	ZE44-8011	ZE44-8012	-
KAWASAKI	TRICKER	04-16	ZE44-8011	ZE44-8012	-
	DT230LANZA	97-99	ZE44-8011	ZE44-8012	-
	KLX125,D-TRACKER125	10-16	ZE44-6011	ZE44-6012	-
SUZUKI	KLX250,D-TRACKER/X	08-16	ZE44-6011	ZE44-6012	-
	DRZ400S/SM	00-16	ZE44-7011	ZE44-7012	ZE44-7013
	DR250R	97-00	ZE44-7011	ZE44-7012	ZE44-7013

Pivot lever CP Replacement

Brake Lever Arm

ZE41-31001	Black	ZE41-31003	Red
ZE41-31002	Blue		

Clutch Lever Arm

ZE42-31001	Black	ZE42-31003	Red
ZE42-31002	Blue		

CONTROL

BARCLAMP

LEVER

FOOT PARTS

HAND GUARD

BODY GUARD

BODY

ACCESSORIES

CARBON

ALUMINUM FOOTPEG



ZETA ALUMINUM FOOT PEGS

- CNC machined A2014 forged aluminum foot peg.
- 57 mm width foot pegs provides better foot peg traction and control.
- Light weight design comes with beautiful anodized finish and zeta laser print logo.
- SUS 304 stainless pins provides better grip.
- Available for recent MX bikes.



RMZ250

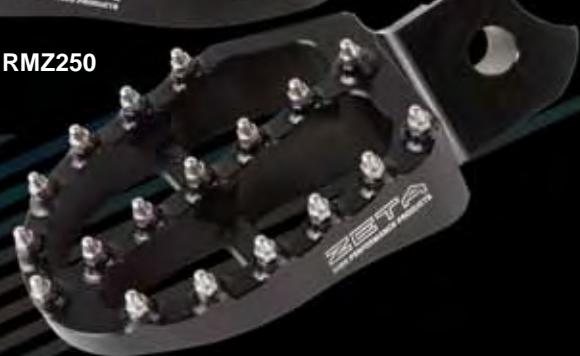

YZ125-450

	Bike	Year	Color
HONDA (Red)	CR125R/250R	02-07	ZE93-1022
	CRF150R	07-17	ZE93-1022
	CRF250R	04-17	ZE93-1022
	CRF450R	02-17	ZE93-1022
	CRF450R X	17	ZE93-1022
	CRF250X	04-17	ZE93-1022
	CRF450X	05-17	ZE93-1022
	CRF250L/M	12-16	ZE93-1022
YAMAHA (Blue)	YZ125	97-17	ZE93-1623
	YZ250	98-17	ZE93-1623
	YZ125X	17	ZE93-1623
	YZ250X	16-17	ZE93-1623
	YZ250X	01-16	ZE93-1623
	YZ250F	17	ZE93-1623 #1
	YZ250FX	15-17	ZE93-1623 #1
	YZ450F	03-15	ZE93-1623
	YZ450FX	16-17	ZE93-1623 #1
	YZ450FX	16-17	ZE93-1623 #1
	WR250F	01-06	ZE93-1623
	WR250F	07-16	ZE93-1623 #1
WR450F	03-15	ZE93-1623	
WR450F	16	ZE93-1623 #1	
WR250R/X	07-17	ZE93-1663	
Kawasaki (Black)	KX250F	09-17	ZE93-1220
	KX450F	09-17	ZE93-1220
SUZUKI (Black)	RMZ250	10-17	ZE93-1420
	RMZ450	08-17	ZE93-1420
	RMX450Z	10-16	ZE93-1420
KTM (Orange)	65SX	09-17	ZE93-1817
	85SX	03-17	ZE93-1817
	125SX/250-450SX-F	98-15	ZE93-1817
		16-17	ZE93-1827
	250SX	98-16	ZE93-1817
		17	ZE93-1827 #2
	125-530 EXC/EXC-F	98-16	ZE93-1817
		17	ZE93-1827 #2
	150-300XC/250XC-F	06-16	ZE93-1817
		17	ZE93-1827
	350-450XC-F	08-15	ZE93-1817
		16-17	ZE93-1827
	200-530XC-W/XCF-W	06-16	ZE93-1817
	125-300XC-W	17	ZE93-1827 #2
	FREERIDE250R	14-17	ZE93-1817
FREERIDE350	12-17	ZE93-1817	

#1 OEM + 5 mm #2 OEM - 5 mm

Footpeg Color

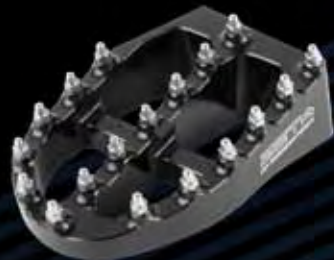

KAWASAKI / SUZUKI



YAMAHA



HONDA



KTM

CONTROL

BARCLAMP

LEVER

FOOT PARTS

HAND GUARD

BODY GUARD

BODY

ACCESSORIES

CARBON

REVOLVER SHIFT

Rotating shift tip provides 6 different positions!

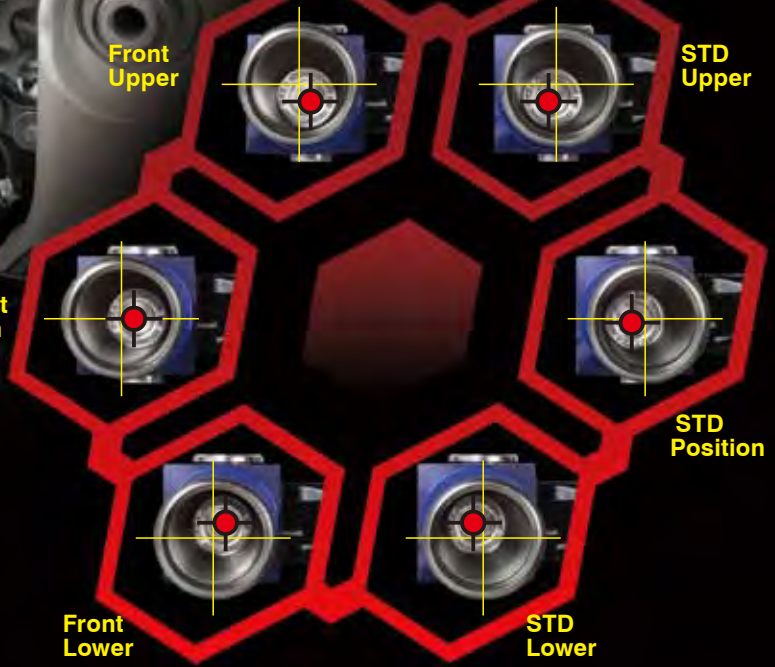

ZETA REVOLVER SHIFT LEVER

- Revolving shift tip design provides best shift positions for all riders.
- Rotating shift tip provides 6 different positions, offer more sensitive shift position adjustment.
- Shift arm is made of A2014 forged aluminum for durability.
- Forged arm is black anodized finish with laser print logo.
- Foldable shift tip is made of CNC aluminum with knurled finish for better shift grip.
- Shift tip is color anodized with ZETA laser print logo.
- Replacement shift tips and tip mounts are available.

Yellow line tip senter

YZ125/250/
YZ125X/250X

CRF450R

KTM SX

YZ250X

Shift tip is color anodized with ZETA laser print logo.

Forged arm is black anodized finish with laser print logo.

REVOLVER SHIFT RACER Application

	Bike	Year	Color	Part #	Rep Shift Tip	Rep Tip Mount
HONDA	CRF50F/70F(Standard)	04-17	Red	ZE90-3502	ZE90-3930	ZE90-3902
	CRF50F/70F(10mm Long)	04-17		ZE90-3512	ZE90-3930	ZE90-3912
	CRF125F	14-17		ZE90-3012	ZE90-3920	ZE90-3902
	CRF150R	07-17		ZE90-3042	ZE90-3920	ZE90-3902
	CR80R/85R	96-07		ZE90-3532	ZE90-3920	ZE90-3902
	XR250R(ME06/ME08)	93-04		ZE90-3532	ZE90-3920	ZE90-3902
	XR400R	96-04		ZE90-3052	ZE90-3920	ZE90-3902
	CRF250R	04-09		ZE90-3052	ZE90-3920	ZE90-3902
	CRF250X	04-17		ZE90-3022	ZE90-3920	ZE90-3902
	CRF250R	10-17		ZE90-3032	ZE90-3930	ZE90-3912
YAMAHA	TTR50E(Standard)	06-16	Blue	ZE90-3506	ZE90-3930	ZE90-3906
	TTR50E(10mmLong)	06-16		ZE90-3516	ZE90-3930	ZE90-3916
	YZ85	07-17		ZE90-3306	ZE90-3920	ZE90-3906
	YZ125/250	06-17		ZE90-3316	ZE90-3920	ZE90-3906
	YZ125X	17		ZE90-3316	ZE90-3920	ZE90-3906
	YZ250X	16-17		ZE90-3316	ZE90-3920	ZE90-3906
	YZ250F	06-13		ZE90-3336	ZE90-3920	ZE90-3916
	YZ250F	14-17		ZE90-3326	ZE90-3930	ZE90-3916
	YZ250FX	15-17		ZE90-3336	ZE90-3920	ZE90-3916
	YZ250F(10mmLong)	06-13		ZE90-3326	ZE90-3930	ZE90-3916
Kawasaki	KX250F	16-17	Red	ZE90-3326	ZE90-3930	ZE90-3916
	WR450F	07-15		ZE90-3336	ZE90-3920	ZE90-3916
	WR450F	16		ZE90-3326	ZE90-3930	ZE90-3916
	KX80/85	09-17		ZE90-3102	ZE90-3920	ZE90-3912
	KX100	14-17		ZE90-3112	ZE90-3920	ZE90-3912
SUZUKI	RMX250R	89-98	Red	ZE90-3242	ZE90-3920	ZE90-3902
	RMZ250	07-17		ZE90-3212	ZE90-3930	ZE90-3902
	RMZ450	08-17		ZE90-3222	ZE90-3920	ZE90-3902
	RMX450Z	10-16		ZE90-3222	ZE90-3920	ZE90-3902

NOTE : After selecting the tip position. Always coat with a screw locking agent, and tighten firmly.

	Bike	Year	Color	Part #	Rep Shift Tip	Rep Tip Mount
KTM	85SX	03-17	Orange	ZE90-3403	ZE90-3920	ZE90-3913
	125SX/EXC	01-15		ZE90-3413	ZE90-3920	ZE90-3913
	150SX	16		ZE90-3433	ZE90-3920	ZE90-3913
	150SX/XC	09-15		ZE90-3413	ZE90-3920	ZE90-3913
	150SX	16		ZE90-3433	ZE90-3920	ZE90-3913
	200EXC	01-16		ZE90-3413	ZE90-3920	ZE90-3913
	200SX/MXC	01-04		ZE90-3413	ZE90-3920	ZE90-3913
	200XC/XC-W	06-15		ZE90-3413	ZE90-3920	ZE90-3913
	250SX-F/XC-F	11-12		ZE90-3423	ZE90-3930	ZE90-3913
	250EXC-F/XCF-F	12-16		ZE90-3423	ZE90-3930	ZE90-3913
	250EXC-F	17		ZE90-3413	ZE90-3920	ZE90-3913
	350SX-F/XC-F	11-17		ZE90-3413	ZE90-3920	ZE90-3913
	350EXC-F/XCF-F	12-16		ZE90-3423	ZE90-3930	ZE90-3913
	450SX	03-06		ZE90-3413	ZE90-3920	ZE90-3913
	450SX-S-F	07-08		ZE90-3413	ZE90-3920	ZE90-3913
	450SX-F	07-12		ZE90-3413	ZE90-3920	ZE90-3913
	450XC-F	08-09		ZE90-3413	ZE90-3920	ZE90-3913
	450SX-F/XC-F	13-15		ZE90-3423	ZE90-3930	ZE90-3913
	450EXC-F	16-17		ZE90-3433	ZE90-3920	ZE90-3913
	450EXC	03-16		ZE90-3423	ZE90-3930	ZE90-3913
450EXC-F	17	ZE90-3433	ZE90-3920	ZE90-3913		
450XC-W	07-16	ZE90-3423	ZE90-3930	ZE90-3913		
500EXC	12-16	ZE90-3423	ZE90-3930	ZE90-3913		
500EXC-F	17	ZE90-3433	ZE90-3920	ZE90-3913		
500XC-W	12-16	ZE90-3423	ZE90-3930	ZE90-3913		
505SX-F	07-08	ZE90-3413	ZE90-3920	ZE90-3913		
505XC-F	08-09	ZE90-3413	ZE90-3920	ZE90-3913		
Husqvarna	TC85	15-17	Blue	ZE90-3406	ZE90-3920	ZE90-3916
	TE125	14-16		ZE90-3416	ZE90-3920	ZE90-3916
	TC125	14-15		ZE90-3416	ZE90-3920	ZE90-3916
	FC250/350	14-17		ZE90-3436	ZE90-3920	ZE90-3916
	FC450	14-15		ZE90-3426	ZE90-3930	ZE90-3916
	FE250-501	16-17		ZE90-3436	ZE90-3920	ZE90-3916
	FE250/350	14-16		ZE90-3426	ZE90-3930	ZE90-3916
	FE450/501	17		ZE90-3416	ZE90-3920	ZE90-3916
	FX350	17		ZE90-3416	ZE90-3920	ZE90-3916
	FX450	17		ZE90-3436	ZE90-3920	ZE90-3916



Replacement Tip Mount

Part #	Color	Description
ZE90-3902	Red	Straight type
ZE90-3906	Blue	
ZE90-3912	Red	Offset type
ZE90-3913	Orange	
ZE90-3916	Blue	

Note replacement chip mount, please use the same shape as the compatibility table. If you install a different shape and may interfere with the engine case cover.



Replacement Shift tip

Part number	Color	Description
ZE90-3920	Titanium	23 mm
ZE90-3930	Titanium	28 mm

	Bike	Year	Color	Part #	Rep Shift Tip	Rep Tip Mount
HONDA	CRM50/80	93-97	Red	ZE90-3512	ZE90-3930	ZE90-3912
	CRM50F/70F	93-97	Blue	ZE90-3516	ZE90-3930	ZE90-3916
	CRM250R/AR	89-00		ZE90-3522	ZE90-3930	ZE90-3902
	XLR250R/BAJA	87-94		ZE90-3532	ZE90-3920	ZE90-3902
	XR250/BAJA/MOTARD	95-07	Red	ZE90-3532	ZE90-3920	ZE90-3902
	CRF250L/M	12-16		ZE90-3042	ZE90-3920	ZE90-3902
YAMAHA	XR400M	05-08		ZE90-3532	ZE90-3920	ZE90-3902
	XT200	82-84	Red	ZE90-3502	ZE90-3930	ZE90-3902
		82-84	Blue	ZE90-3506	ZE90-3930	ZE90-3906
	DT200WR	91-94	Red	ZE90-3502	ZE90-3930	ZE90-3902
		91-94	Blue	ZE90-3506	ZE90-3930	ZE90-3906
	DT230LANZA	97-00	Red	ZE90-3512	ZE90-3930	ZE90-3912
KAWASAKI	WR250R/X	97-00	Blue	ZE90-3516	ZE90-3930	ZE90-3916
		07-17		ZE90-3346	ZE90-3930	ZE90-3906
	KLX125,D-TRACKER125	10-16		ZE90-3532	ZE90-3920	ZE90-3902
	KDX125SR	92-99	Red	ZE90-3602 #	ZE90-3920	ZE90-3902
	KDX200SR	90-93		ZE90-3602 #	ZE90-3920	ZE90-3902
	KDX220SR	94-99		ZE90-3602 #	ZE90-3920	ZE90-3902
SUZUKI	KDX250SR	92-94		ZE90-3602 #	ZE90-3920	ZE90-3902
	KL250 Super Sherpa	97-07	Blue	ZE90-3502	ZE90-3930	ZE90-3902
	KL250 Super Sherpa	97-07	Red	ZE90-3506	ZE90-3930	ZE90-3906
	KLX250,D-TRACKER	01-16		ZE90-3142	ZE90-3920	ZE90-3902
	RMX250S	96-98		ZE90-3242	ZE90-3920	ZE90-3902
	250SB	02-06	Red	ZE90-3142	ZE90-3920	ZE90-3902
	DR-Z400S/SM	00-16		ZE90-3242	ZE90-3920	ZE90-3902

After selecting the chip position is always coated with a screw locking agent, please tighten firmly. **ZE90-3062 (KDX125SR / 200SR / 220SR / 250SR) up and down the shift position is with the use of only genuine position.**



ZETA FORGED SHIFT LEVER

- Forged lever arm shift lever available from ZETA.
- Shift arm is made of A2014 forged aluminum for durability.
- Forged arm is black anodized finish.
- Foldable shift tip is made of CNC aluminum with knurled finish for better shift grip.
- Shift tip is color anodized with ZETA laser print logo.
- Available for most motocross and dual sport models.

RACER Application

Bike	Year	Color	Part #
HONDA			
CRF50F/70F(Standard)	04-17	Red	ZE90-4502
CRF50F/70F(10mm Long)	04-17		ZE90-4512
CRF125F	14-17		ZE90-4512
CRF150R	07-17		ZE90-4012
CR80R/85R	96-07		ZE90-4042
XR250R(ME06/ME08)	93-04		ZE90-4532
XR400R	96-04	ZE90-4532	
CRF250R	04-09	ZE90-4052	
CRF250X	10-17	ZE90-4022	
CRF450R	04-17	ZE90-4052	
	07-16	ZE90-4032	
YAMAHA			
TTR50E(Standard)	06-16	Blue	ZE90-4506
TTR50E(10mmLong)	06-16		ZE90-4516
YZ85	07-17		ZE90-4306
YZ125/250	06-17		ZE90-4316
YZ125X	17		ZE90-4316
YZ250X	16-17		ZE90-4316
YZ250F	06-13	ZE90-4336	
YZ250FX	14-17	ZE90-4326	
YZ250FX	15-17	ZE90-4356	
YZ450F(10mmLong)	06-13	ZE90-4336	
YZ450F	14-17	ZE90-4326	
YZ450FX	16-17	ZE90-4326	
WR250F	07-13	ZE90-4336	
WR450F	15-16	ZE90-4356	
	07-15	ZE90-4336	
	16	ZE90-4326	
KAWASAKI			
KX80/85	09-17	Red	ZE90-4102
KX100	14-17		ZE90-4102
KX250F/450F	09-17		ZE90-4112
SUZUKI			
RMX250R	89-98	Red	ZE90-4242
RMZ250	07-17		ZE90-4212
RMZ450	08-17		ZE90-4222
RMX450Z	10-16		ZE90-4222

DUAL SPORTS Application

Bike	Year	Color	Part #
HONDA			
CRM50/80	93-97	Red	ZE90-4512
	93-97	Blue	ZE90-4516
CRM250R/AR	89-00	Red	ZE90-4522
XLR250R/BAJA	87-94		ZE90-4532
XR250/BAJA/MOTARD	95-07		ZE90-4532
CRF250L/M	12-16		ZE90-4042
XR400M	05-08	ZE90-4532	
YAMAHA			
XT200	82-84	Red	ZE90-4502
	82-84	Blue	ZE90-4506
DT200WR	91-94	Red	ZE90-4502
	91-94	Blue	ZE90-4506
DT230LANZA	97-00	Red	ZE90-4512
	97-00	Blue	ZE90-4516
WR250R/X	07-17		ZE90-4346
KAWASAKI			
KLX125,D-TRACKER125	10-16	Red	ZE90-4532
KDX125SR	92-99		ZE90-4602 #
KDX200SR	90-93		ZE90-4602 #
KDX220SR	94-99		ZE90-4602 #
KDX250SR	92-94	ZE90-4602 #	
KL250 Super Sherpa	97-07		ZE90-4502
KLX250,D-TRACKER	01-16	Blue	ZE90-4506
	01-16	Red	ZE90-4142
SUZUKI			
RMX250S	96-98	Red	ZE90-4242
250SB	02-06		ZE90-4142
DR-Z400S/SM	00-16		ZE90-4242

ZE90-4062 (KDX125SR / 200SR / 220SR / 250SR) up and down the shift position is with the use of only genuine position.

CONTROL

BARCLAMP

LEVER

FOOT PARTS

HAND GUARD

BODY GUARD

BODY

ACCESSORIES

CARBON

CONTROL

BARCLAMP

LEVER

FOOT PARTS

HAND GUARD

BODY GUARD

BODY

ACCESSORIES

CARBON



ZE90-7423
KTM



ZE90-7012
CRF250R/450R



ZE90-7416
Husqvarna

ZETA

TRIGGER BRAKE PEDAL

- Brake arm is made of forged A2014 aluminum for durability.
- Smooth surface design as OE brake arm.
- Black anodized finish with laser print logo.
- Brake tip is made of CNC machined A7079 aluminum with anodized finish.
- Bolt, pin and spring are made of stainless steel for less corrosion.
- Comes with brake saver.



Black anodized finish with laser print logo.



Thin tip design to prevent it from hitting the ground. Designed to prevent sand and mud from entering the tip folding area from front and side of brake tips. Pins are designed for sensitive pedal control and traction.



Designed to prevent sand and mud from entering tip folding area from front and side of brake tips.



Provides 2 different positions.

	Bike	Year	Color	Part #
HONDA	CRF250R	04-17	Red	ZE90-7012
	CRF450R	05-17	Red	ZE90-7012
	CRF450RX	17	Red	ZE90-7012
	CRF250L/M	12-16	Red	ZE90-7022
YAMAHA	YZ125/250	05-17	Blue	ZE90-7316
	YZ125X	17	Blue	ZE90-7316
	YZ250X	16-17	Blue	ZE90-7316
	YZ250F	10-17	Blue	ZE90-7326
	YZ250FX	15-17	Blue	ZE90-7326
	WR250F	15-16	Blue	ZE90-7326
	YZ450F	10-17	Blue	ZE90-7336
	YZ450FX	16-17	Blue	ZE90-7336
	WR450F	12-16	Blue	ZE90-7336
	WR250R/X	07-17	Blue	ZE90-7346
KAWASAKI	KX250F	06-17	Red	ZE90-7112
	KX450F	16-17	Red	ZE90-7122
	KLX250/D-Tracker	01-16	Red	ZE90-7182
SUZUKI	RMZ250	13-17	Red	ZE90-7212
	RMZ450	08-17	Red	ZE90-7222
	250SB	02-06	Red	ZE90-7182
	DRZ400S/SM	00-16	Red	ZE90-7282
KTM	125EXC	11-16	Orange	ZE90-7413
	125SX	11-15	Orange	ZE90-7413
		16-17	Orange	ZE90-7423
	125XC-W	17	Orange	ZE90-7423
	150SX/XC	11-15	Orange	ZE90-7413
	150SX/XC-W	16-17	Orange	ZE90-7423
	200EXC/XC/XC-W	01-16	Orange	ZE90-7413
	250SX	11-16	Orange	ZE90-7413
		11-15	Orange	ZE90-7413
	250SX-F/XC-F	16-17	Orange	ZE90-7423
	250EXC-F/XCF-W	11-16	Orange	ZE90-7413
	300XC/XC-W	11-16	Orange	ZE90-7413
	350SX-F/XC-F	11-15	Orange	ZE90-7413
	350EXC-F/XCF-W	11-16	Orange	ZE90-7413
	450SX-F/XC-F	11-15	Orange	ZE90-7413
	450SX-F	16-17	Orange	ZE90-7423
	450EXC/XC-W	12-16	Orange	ZE90-7413
450EXC-F	17	Orange	ZE90-7423	
500EXC/XC-W	12-16	Orange	ZE90-7413	
500EXC-F	17	Orange	ZE90-7423	
HUSQVARNA	TE150	17	Blue	ZE90-7426
	TE250/300	14-16	Blue	ZE90-7416
	FE250-501	14-16	Blue	ZE90-7416
	FE450/501	17	Blue	ZE90-7426
	TC125	16-17	Blue	ZE90-7426
	TC250	14-16	Blue	ZE90-7416
	FC250/350/450	14-15	Blue	ZE90-7416
		16-17	Blue	ZE90-7426
	TX125	17	Blue	ZE90-7426
FX350/450	17	Blue	ZE90-7426	

After selecting the TIP position, please apply a screw lock agent to be sure to bolt.



Replacement Tip Mount	Color	Part #
	Red	ZE90-7902
	Orange	ZE90-7903
	Blue	ZE90-7906

Kawasaki
Racing Team

JMX

ZETA

STINGRAY VENT HAND GUARD

- ZETA vented Stingray hand guards, used by Japanese Factory Kawasaki and Factory Suzuki.
- Vented design cools your hand during hard riding, yet it protects your hand from brush, roots and the elements. Light weight design.
- Handlebar clamp style hand guards fits almost all dirt bikes and ATVs.
- Available in 7 factory colors, replacement shields available.

Part #	Color	Part #	Color	Part #	Color
ZE74-3101	Black	ZE74-3107	Yellow	ZE74-3109	Orange
ZE74-3104	Blue	ZE74-3108	Green	ZE74-3110	White
ZE74-3105	Red				

Replacement Shields

Part #	Color	Part #	Color	Part #	Color
ZE74-3201	Black	ZE74-3207	Yellow	ZE74-3209	Orange
ZE74-3204	Blue	ZE74-3208	Green	ZE74-3210	White
ZE74-3205	Red				

ZETA

STINGRAY HAND GUARD

- Handlebar clamp style hand guard.
- Protect your hand from brush, roots and the elements.
- Fits almost all dirt bikes, ATVs and more. Universal fit.
- Colors available : Black, Red, Blue, Yellow, Green, Orange and White.
- Comes complete with all mounting hardware.
- Replacement shields available.

Part #	Color	Part #	Color	Part #	Color
ZE74-2101	Black	ZE74-2107	Yellow	ZE74-2109	Orange
ZE74-2104	Blue	ZE74-2108	Green	ZE74-2110	White
ZE74-2105	Red				

Replacement Shields

Part #	Color	Part #	Color	Part #	Color
ZE74-2201	Black	ZE74-2207	Yellow	ZE74-2209	Orange
ZE74-2204	Blue	ZE74-2208	Green	ZE74-2210	White
ZE74-2205	Red				

ZETA

IMPACT X2 HAND GUARD

- 2nd generation of impact hand guards.
- New compact hand guard shells with aero dynamic design. Fits most dirt bikes and ATVs.
- Compact shells design for riders looking for small hand guard shells. Mini mx racing models and ATVs.
- Available in 7 factory colors, replacement shields available.

Part #	Color	Part #	Color	Part #	Color
ZE74-0201	Black	ZE74-0207	Yellow	ZE74-0209	Orange
ZE74-0204	Blue	ZE74-0208	Green	ZE74-0210	White
ZE74-0205	Red				

Replacement Shields

Part #	Color	Part #	Color	Part #	Color
ZE74-1201	Black	ZE74-1207	Yellow	ZE74-1209	Orange
ZE74-1204	Blue	ZE74-1208	Green	ZE74-1210	White
ZE74-1205	Red				

Stingray ^{Vented}



Available in 7 colors

Stingray



Available in 7 colors

IMPACT X2



Available in 7 colors

Replacement Mounting Kit

Part number
ZE74-0910



Provides 3 different guard positions



Hand guard attachment fits above or below lever

CONTROL

BARCLAMP

LEVER

FOOT PARTS

HAND GUARD

BODY GUARD

BODY

ACCESSORIES

CARBON

ZETA

PRO ARMOR HAND GUARD

- Upgraded armor hand guards for pro rider use.
- Comes with durable plastic bumpers to protect the armor hand guard body.
- Comes with durable longer bar end adapters which holds the handlebars tighter.
- Matching design between hand guard body and bar end adapter prevents rotation of hand guards in the event of a fall.
- Can be used with Zeta hand guard mount kits: side, front and BC type, for durable fitting.
- Available in Titanium, black and orange anodized colors.
- Replacement hand guard bumpers and bar end adapters are available.

Part #	Color
ZE71-8001	Black
ZE71-8003	Titanium
ZE71-8006	Orange

Replacement ProBar End Adapter
Part number **ZE71-8921**

Replacement bumper
Part number **ZE71-8911**

Matching design

Plastic bumper

CONTROL

BARCLAMP

LEVER

FOOT PARTS

HAND GUARD

BODY GUARD

BODY

ACCESSORIES

CARBON

ZETA

ARMOR HAND GUARDS Bend 28.6 mm U-clamp

- Armor hand guard comes with U clamp bar mount.
- The best to use this hand guard for KTM and Husqvarna or other models which uses hydraulic clutch master cylinder.
- U shape handlebar clamp provides more space for hydraulic oil line or cables.
- Made of durable aluminum, Drop down design provides better control.
- Available for 28.6 mm handlebars.
- Can be used with ZETA hand guard protectors.

Part #	Color
ZE72-0151	Black
ZE72-0153	Titanium

ZETA

U-CLAMP KIT

- U shape armor hand guard bar mount kit.
- Unique U shape design clamp does not touch clutch cable and, oil line or brake line.
- Made of durable aluminum, available in 2 different size clamps, 28.6 mm and 22.2 mm.
- Comes in pairs.

Part #	Size
ZE71-1618	1-1/8" (28.6 mm)
ZE71-1718	7/8" (22.2 mm)

ZE71-1618

ZE71-1718

ZETA

**HAND GUARD BC - MOUNT
KTM / HUSQVARNA**

- Armor hand guard mount kit developed for KTM and HUSQVARNA.
- Bar clamp mount style does not interfere with brake and clutch hoses.
- Provides more durable fitting of ZETA armor hand guards.
- Prevents rotation of hand guards, protects your control levers and throttle in the event of a fall.
- Made of CNC machined A7009 aluminum, hard anodized titanium color with laser printed logo.
- Comes with special installation bolts.

Part #	Color
ZE71-1831	Titanium

ZETA
ARMOR HAND GUARD BEND

- Durable aluminum hand guards.
- Made of A7009-T6 aluminum for extreme strength.
- Drop down design provides better control.
- Holes are pre-drilled for mounting of ZETA protector shields.
- All mounting hardware included, replacement hardware available.
- Hand guards available for 7/8" (22.2 mm) bars and 1-1/8" (28.6 mm) bars.
- Available in 4 colors : Black, Titanium-color, Red and Blue.

for 7/8" (22.2 mm) bars	
Part #	Color
ZE72-0001	Black
ZE72-0003	Titanium
ZE72-0004	Red
ZE72-0005	Blue

for 1-1/8" (28.6 mm) bars	
Part #	Color
ZE72-0101	Black
ZE72-0103	Titanium
ZE72-0104	Red
ZE72-0105	Blue



ZETA
ARMOR HAND GUARD STRAIGHT

- Standard straight end design aluminum hand guards.
- Made of A7009-T6 aluminum for extreme durability.
- Holes are pre-drilled for mounting of ZETA protector shields.
- All mounting hardware included, replacement hardware available.
- Hand guards available for 7/8" (22.2 mm) bars and 1-1/8" (28.6 mm) bars.
- Available in 2 colors : Titanium-color and Black

for 7/8" (22.2 mm) bars	
Part #	Color
ZE72-0011	Black
ZE72-0013	Titanium

for 1-1/8" (28.6 mm) bars	
Part #	Color
ZE72-0111	Black
ZE72-0113	Titanium



- Top triple clamp rigid mount kit for Armor hand guards provides more durable fitting.
- Prevents rotation of hand guards, protects your control levers and throttle in the event of a fall.
- Can be used on motorcycles with the top clamp fork bolts attached from the side or front.
- Made of CNC machined A7009 aluminum, hard anodized titanium color with laser printed logo.
- Comes with special installation bolts.

- * Can not be used on top clamps with the fork bolts attached from the back.
- * Hand guard modification may be needed to attach some handlebar bends.

ZETA
HAND GUARD MOUNT
SIDE TYPE & FRONT TYPE

SIDE TYPE
Can be used on motorcycles with the top clamp fork bolts attached from the side.

Part #	Color	Bolt center pitch
ZE71-1822	Titanium	16 - 30 mm

FRONT TYPE
Can be used on motorcycles with the top clamp fork bolts attached from the front.

Part #	Color	Bolt center pitch
ZE71-1821	Titanium	16 - 30 mm

Replacement Bar End Adapter
Bar inner diameter : 13.5 mm - 19.0 mm
ZE71-7911

Replacement Clamp
1-1/8" (28.6 mm) **ZE71-1612**
7/8" (22.2 mm) **ZE71-1712**

Replacement Clamp (long)
1-1/8" (28.6 mm) **ZE71-1613**
7/8" (22.2 mm) **ZE71-1713**

CONTROL

BARCLAMP

LEVER

FOOT PARTS

HAND GUARD

BODY GUARD

BODY

ACCESSORIES

CARBON

ZETA

X2 PROTECTOR

- Compact deflector-shields for Armor hand guards.
- Light weight design for better handling and more space for your hands.
- Great to use for Super moto and ED race.
- Comes with mounting screws for armor hand guards.
- Available in 7 colors.

Part #	Color	Part #	Color	Part #	Color
ZE72-0304	Blue	ZE72-0307	Yellow	ZE72-0310	White
ZE72-0305	Red	ZE72-0308	Green		
ZE72-0306	Black	ZE72-0309	Orange		

X2 PROTECTOR

ZETA

XC PROTECTOR

- Larger deflector-shields for Armor hand guards.
- Suitable for ENDURO race.
- Larger shields protect hands from brush, roots and the elements.
- Slit holes on the shells reduce air resistance.
- Comes with mounting screws for armor hand guards.
- Optional XC flashers can be mounted.
- Available in 7 colors.

Part #	Color	Part #	Color	Part #	Color
ZE72-3104	Blue	ZE72-3107	Yellow	ZE72-3110	White
ZE72-3105	Red	ZE72-3108	Green		
ZE72-3106	Black	ZE72-3109	Orange		

XC Optional Flasher

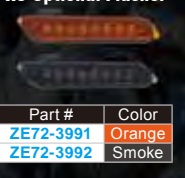

Part #	Color
ZE72-3991	Orange
ZE72-3992	Smoke

XC PROTECTOR

ZETA

XC FLASHER PROTECTOR

- XC protector with flasher.
- Allows removal of stock flashers for reduced weight and better handling.
- Comes with mounting screws for armor hand guards.
- Available in 3 colors.

Orange Lens

Part #	Color
ZE72-3406	Black
ZE72-3409	Orange
ZE72-3410	White

Smoke Lens

Part #	Color
ZE72-3506	Black
ZE72-3509	Orange
ZE72-3510	White

XC FLASHER PROTECTOR

ZETA

XC-PRO PROTECTOR

- Largest deflector-shields for Armor hand guards.
- Protect your hands from brush, roots and the elements.
- Best to use for Extreme, hard Enduro racing.
- Comes with mounting screws for armor hand guards.
- Can be mounted with optional XC flashers.
- Available in 2 colors, white and black.

Part #	Color
ZE72-4106	Black
ZE72-4110	White

XC Optional Flasher



Part #	Color
ZE72-3991	Orange
ZE72-3992	Smoke

XC-PRO PROTECTOR

ZETA

DEFLECTOR MOUNT KIT

- Deflector mount attached by using rear view mirrors.
- Can be used on motorcycle that have mirror holes on the right and left side.
- All ZETA armor hand guard shells can be installed to protect your hands from cold wind, brush, roots and the elements.
- Comes with protector attaching nuts.

Black **ZE72-0590**





*Disc guard mount sold separately

ZETA FRONT DISC GUARD MOUNTING KIT

- Model specific mounting kit. (Required for disc guard installation.)
- Mount bracket is integrated with wheel spacer.
- Comes with disc guard mounting stainless bolts.

	Bike	Year	Part #
HONDA	CR125R/250R	04-07	ZE52-1120
	CRF250R	04-17	ZE52-1120
	CRF450R	04-17	ZE52-1120
	CRF450RX	17	ZE52-1120
	CRF250X/450X	04-17	ZE52-1120
	CRF250L/M	12-16	ZE52-1180
YAMAHA	YZ125/250	08-17	ZE52-1420
	YZ250F	07-13	ZE52-1420
		14-17	ZE52-1430
	YZ450F	07-13	ZE52-1420
		14-17	ZE52-1430
	YZ125X	17	ZE52-1420
	YZ250X	16-17	ZE52-1420
	YZ250FX	15-17	ZE52-1430
	YZ450FX	16-17	ZE52-1430
	WR250F	06-16	ZE52-1420
WR450F	06-16	ZE52-1420	
WR250R	07-17	ZE52-1470	
KAWASAKI	KX125/250	06-08	ZE52-1220
	KX250F/450F	06-17	ZE52-1220
	KLX450R	08-09	ZE52-1220
	KLX125	10-16	ZE52-1280
	KLX150S	09-13	ZE52-1280
SUZUKI	KLX250	08-16	ZE52-1270
	RM-Z250	07-17	
	RM-Z450	05-17	ZE52-1320
RMX450Z	10-16		
KTM	125-530SX/SX-F/XC/XC-F	03-14	ZE52-1520
		15-17	ZE52-1530
	125-530EXC/EXC-F	03-15	ZE52-1520
		16-17	ZE52-1530
Husqvarna	CR/WR 125-300	09-11	ZE52-1610
	TC/TE 250-511	09-11	ZE52-1610
	TC/FC 125-450	14	ZE52-1520
		15-17	ZE52-1530
	TE/FE 125-501	14-15	ZE52-1520
		16-17	ZE52-1530
	TX/FX125-450	17	ZE52-1530

ZETA PRO FRONT DISC GUARD

- New design of durable plastic front disc guard.
- Developed with factory Kawasaki racing team and Yamaha racing team in Japan, and used on their race bikes.
- Protect your front disc and brake caliper from rocks, bushes and debris during your ride.
- 270 mm disc guard size accepts most dirt bike's front brake disc.
- Model specific mount kit is required to install the disc guards on your bike.
- Available black and white color.

Part number	Color
ZE52-1041	Black
ZE52-1046	White

CONTROL



BARCLAMP



LEVER



FOOT PARTS



HAND GUARD



BODY GUARD



BODY



ACCESSORIES



CARBON





ZE80-7002

ZE80-7102

ZE80-7306

ZE80-7326

ZETA
CASE SAVER

- Made of CNC 6061 aluminum for durability.
- CNC machined case saver, red and blue anodized finish.
- 6 mm case saver body for durability, protects your engine case better than stock OEM 3 mm case saver.
- Available in Blue and Red Colors.



ZETA CASE SAVER

	Bike	Year	Part #	
			Red	Blue
HONDA	CRF250R	10-17	ZE80-7002	-
	CRF450R	10-16	ZE80-7002	-
YAMAHA	YZ125/250	06-17	-	ZE80-7306
	YZ250F/450F	14-17	-	ZE80-7326
	YZ125X	17	-	ZE80-7306
	YZ250X	16-17	-	ZE80-7316
	YZ250FX	15-17	-	ZE80-7326
	YZ450FX	16-17	-	ZE80-7326
	WR250F	15-16	-	ZE80-7326
KAWASAKI	WR450F	16	-	ZE80-7326
	KX250F	17	ZE80-7102	ZE80-7106
SUZUKI	KX450F	16-17	ZE80-7102	ZE80-7106
	RMZ250/450	11-17	ZE80-7202	ZE80-7206

CONTROL

BARCLAMP

LEVER

FOOT PARTS

HAND GUARD

BODY GUARD

BODY

ACCESSORIES

CARBON



ZE80-8002

ZE80-8326

ZETA
CASE SAVER with COVER

- Case saver comes with light weight and durable drive cover.
- Drive cover is made of A6061 laser cut aluminum.
- Sand blasted black anodized finish with laser print logo.
- Made of 2 mm aluminum with pressed construction for extreme durability and light weight.
- Available in Blue and Red case saver colors.



ZETA CASE SAVER WITH COVER

	Bike	Year	Part #	
			Red	Blue
HONDA	CRF250R	10-17	ZE80-8002	-
	CRF450R	10-16	ZE80-8002	-
YAMAHA	YZ125/250	06-17	-	ZE80-8306
	YZ250F/450F	14-17	-	ZE80-8326
	YZ125X	17	-	ZE80-8306
	YZ250X	16-17	-	ZE80-8316
	YZ250FX	15-17	-	ZE80-8326
	YZ450FX	16-17	-	ZE80-8326
	WR250F	15-16	-	ZE80-8326
KAWASAKI	WR450F	16	-	ZE80-8326
	KX250F	17	ZE80-8102	ZE80-8106
SUZUKI	KX450F	16-17	ZE80-8102	ZE80-8106
	RMZ250/450	11-17	ZE80-8202	ZE80-8206

Drive cover	Year	Red	Blue	Ti-Color
HONDA				
CRF150R	07-17	ZE80-9045	-	-
CR250R	02-07	ZE80-9015	ZE80-9014	-
CRF250R	04-09	ZE80-9015	ZE80-9014	-
	10-17	ZE80-9355	-	-
CRF250X	04-17	ZE80-9015	ZE80-9014	-
	05-07	ZE80-9045	-	-
CRF450R	08	ZE80-9015	ZE80-9014	-
	09-16	ZE80-9355	-	-
CRF450X	05-16	ZE80-9045	-	-
CRF250L/M	12-16	ZE80-9315	-	-
XR250/BAJA	95-02	-	-	ZE80-9306
XR250/MOTARD	03-07	-	-	ZE80-9306
YAMAHA				
YZ125	05-17	ZE80-9015	ZE80-9014	-
YZ250	99-17	ZE80-9025	ZE80-9024	-
	01-13	ZE80-9025	ZE80-9024	-
YZ250F	14-17	-	ZE80-9374	-
	03-13	ZE80-9075	ZE80-9074	-
	14-17	-	ZE80-9374	-
YZ125X	17	ZE80-9015	ZE80-9014	-
YZ250X	16-17	ZE80-9025	ZE80-9024	-
YZ250FX	15-17	-	ZE80-9374	-
YZ450FX	16-17	-	ZE80-9374	-
WR250F	01-14	ZE80-9025	ZE80-9024	-
	15-16	-	ZE80-9374	-
WR450F	03-15	ZE80-9075	ZE80-9074	-
	16	-	ZE80-9374	-
WR250R/X	07-17	-	ZE80-9614	-
TRICKER	04-16	-	-	ZE80-9606
SEROW250	05-16	-	-	ZE80-9606
XT250X	06-16	-	-	ZE80-9606
KAWASAKI				
KX125	03-08	ZE80-9055	ZE80-9054	-
KX250	05-08	ZE80-9055	ZE80-9054	-
KX250F	04-16	ZE80-9035	ZE80-9034	-
	17	ZE80-9055	ZE80-9054	-
KX450F	06-17	ZE80-9055	ZE80-9054	-
KLX125, D-TRACKER125	10-16	-	-	ZE80-9416
KLX150S	09-13	-	-	ZE80-9416
KLX250/ES/SR	93-16	-	-	ZE80-9406
D-TRACKER	98-16	-	-	ZE80-9406
SUZUKI				
RMZ250	04-06	ZE80-9035	ZE80-9034	-
	07-17	ZE80-9025	ZE80-9024	-
RMZ450	05-17	ZE80-9025	ZE80-9024	-
DRZ400S/SM	00-16	-	-	ZE80-9506
250SB	02-06	-	-	ZE80-9406



ZETA DRIVE COVER

- CNC machined front sprocket cover.
- Designed to keep mud out of the front sprocket area.
- Available in red, blue and titanium anodized colors.
- Made of A7009-T6 aluminum.



YZ250



CRF250R

Heel Guard	Part #
XR250/Baja '95-	ZE81-2008
CRF250L/M	ZE81-2008
CRM250R/AR	ZE81-2008
Serow225,TW200/225	ZE81-2008
DRZ125/400S/400SM	ZE81-2003
KLX125,D-Tracker125	ZE81-2021
KLX150S	ZE81-2021
Serow250	ZE81-2041
WR250R/X	ZE81-2042



ZETA HEEL GUARD

- Protects your heel from the chain and the rear sprocket.
- Made of CNC machined A7009-T6 aluminum.
- Finished in anodized titanium-color.

Rear Disk Guard	Part #
XR250/BAJA '95- ,XLR250	ZE84-0111
DRZ400SM	ZE84-0131
WR250R/X	ZE84-0141



ZETA REAR DISC GUARD

- Protects your rear disc from rocks and roots.
- Simple bolt-on application.
- Made of CNC machined A7009-T6 aluminum.
- Finished in anodized titanium-color.

Chain Guard Brace	Part #
XR250/Baja/Motard '95-	ZE82-0211
CRF250L/M	ZE82-0211
Serow250,Tricker(XG250),XT250X	ZE82-0241



ZETA CHAIN GUARD BRACE

- Protects your chain guide from rocks and other debris.
- Made of CNC machined A7009-T6 aluminum.
- Finished in anodized titanium-color.
- Chain guard for XR can be attached offset in the forward position by using the extra screw holes enabling the use of up to 46T sprockets.
- Simple bolt-on application.

CONTROL

BARCLAMP

LEVER

FOOT PARTS

HAND GUARD

BODY GUARD

BODY

ACCESSORIES

CARBON



YZ250FX Right



YZ250FX Left

ZETA
FRAME GUARD

- Provides a flat surface on the motorcycle frame for better foot grips and bike control.
- Prevents frame scratches during your ride.
- Made of 5000 grade aluminum with ZETA embossed logo

Bike	Year	Part #
HONDA		
CRF125F	14-17	ZE52-0003
CRF150F/230F	03-17	ZE52-0011
CRF150R	07-17	ZE52-0032
CRF250R	14-17	ZE52-0042
CRF450R	13-16	ZE52-0042
XR230	05-12	ZE52-0010
XR250R	86-95	ZE52-0013
	96-04	ZE52-0015
XR250	95-07	ZE52-0015
XLR250	88-94	ZE52-0013
CRF250L	12-16	ZE52-0018
CRM50/80	88-92	ZE52-0001
	93-98	ZE52-0002
CRM250R/AR	89-98	ZE52-0008
YAMAHA		
YZ85	02-17	ZE52-0332
YZ125/250	05-17	ZE52-0336
YZ250F	14-16	ZE52-0341
YZ125X	17	ZE52-0336
YZ250X	16-17	ZE52-0336
YZ250FX	15-16	ZE52-0341
SEROW225W	93-96	ZE52-0311
SEROW250	05-16	ZE52-0313
TRICKER	04-16	ZE52-0313
TTR125/LW	00-06	ZE52-0304
TT250R/RAID	93-97	ZE52-0309
WR250R/X	07-17	ZE52-0322
DT200WR	91-94	ZE52-0302
DT230LANZA	97-98	ZE52-0303
KAWASAKI		
KX65	00-17	ZE52-0130
KX85	01-17	ZE52-0132
KX250F	13-16	ZE52-0142
KX450F	09-16	ZE52-0152
KLX125, D-TRACKER125	10-16	ZE52-0103
KLX250, D-TRACKER/X	98-16	ZE52-0106
KDX125SR	90-99	ZE52-0110
KDX200SR	89-93	ZE52-0112
KDX220SR	94-99	ZE52-0114
KDX250SR	91-94	ZE52-0116
SUPER SHERPA	97-07	ZE52-0105
SUZUKI		
RM85	02-16	ZE52-0232
RMZ250	10-15	ZE52-0242
RMZ250	16-17	ZE52-0243
RMX250R	96-98	ZE52-0206
RMX250S	96-98	ZE52-0206
DR250S	90-94	ZE52-0211
DR250R/DJEBEL	95-06	ZE52-0213
DRZ400S/SM	00-15	ZE52-0215
KTM		
65SX	09-16	ZE52-0401
85SX	13-17	ZE52-0403



WR250R/X



YZ250FX



KX85



DRZ400S/SM

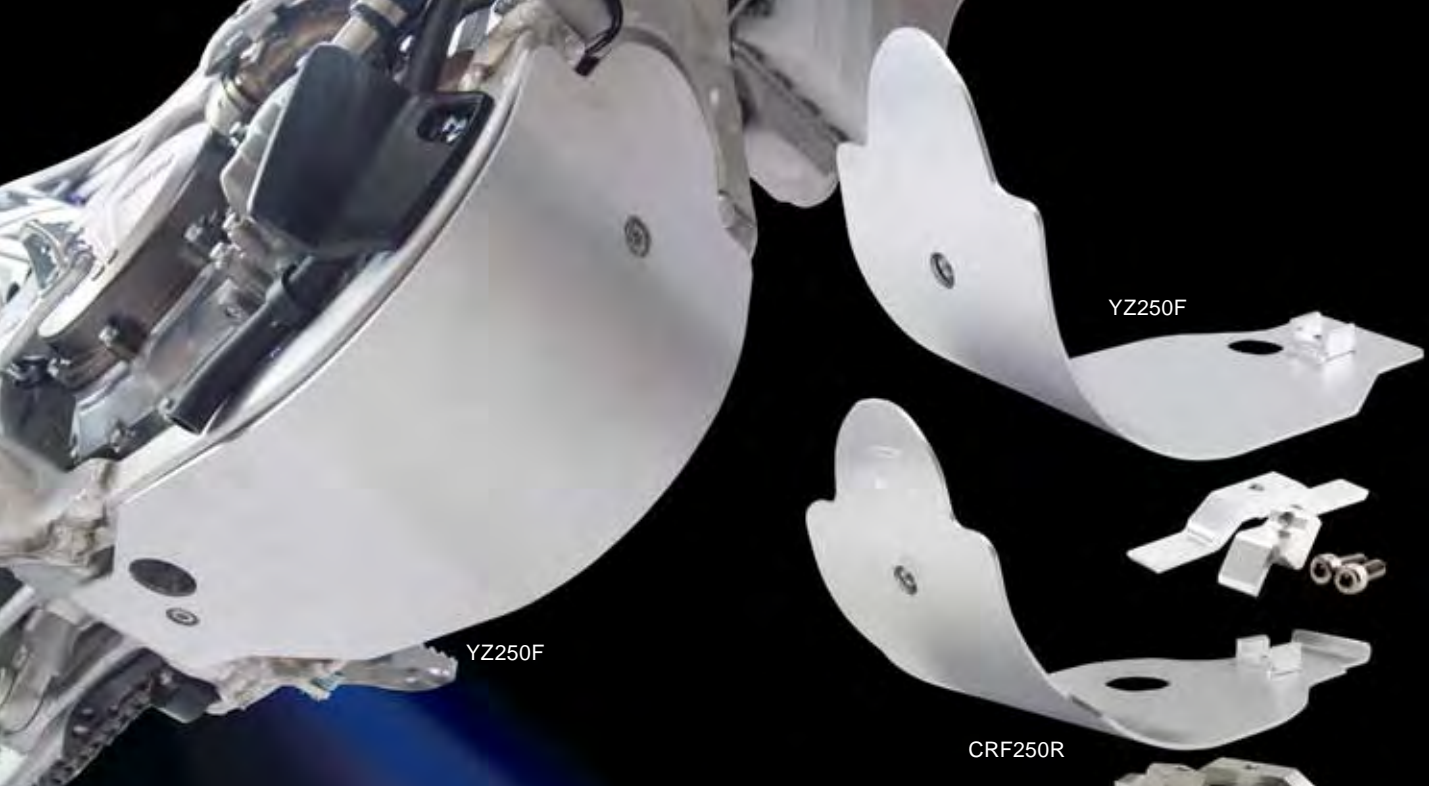

YZ250F

YZ250F

CRF250R

Bike	Year	Part #
HONDA		
CRF250R	10-13	ZE55-3112
	14-17	ZE55-3113
	09-14	ZE55-3132
CRF450R	15	ZE55-3133
YAMAHA		
YZ250F	10-13	ZE55-3412
	14-16	ZE55-3433
	06-09	ZE55-3431
YZ450F	10-13	ZE55-3432
	14-16	ZE55-3433

Bike	Year	Part #
KAWASAKI		
KX250F	09-16	ZE55-3212
	09-14	ZE55-3232
		16
SUZUKI		
RMZ250	07-12	ZE55-3311
KTM		
450SX-F	07-10	ZE55-3561

ZETA MX GLIDE PLATE

- Glide plate made of 5000 grade durable aluminum for MX racing bikes.
- Model specific applications.
- Oil drain hole allows easy oil changes without removing the glide plate.
- All mounting hardware included.



YZ250FX

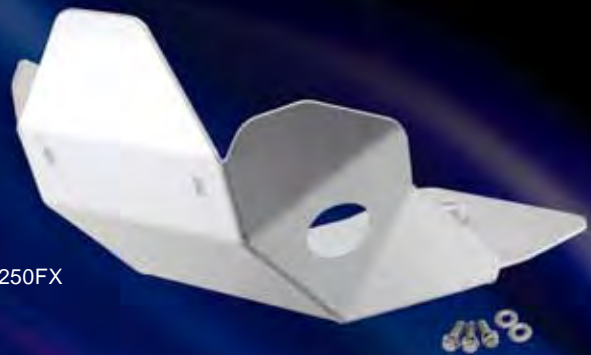

ZETA ED SKID PLATE

- Made of 5000 grade durable aluminum.
- Protects the area under engine, water pump cover and crankcase from stones and rocks.
- Oil drain hole allows easy oil changes without removing the skid plate.
- All mounting hardware included.



DRZ400

KLX250, D-Tracker250

WR250R/X

Bike	Year	Part #
H	XR230/MOTARD	05-12 ZE55-2120
	XR250/BAJA/MOTARD	95-07 ZE55-2100
	CRF250L	12-15 ZE55-2130
Y	YZ125	05-17 ZE55-2460
	YZ250	05-17 ZE55-2440
	YZ125X	17 ZE55-2460
	YZ250X	16-17 ZE55-2440
	YZ250FX	15-16 ZE55-2430
	WR250F	15-16 ZE55-2430
	WR250R/X	07-17 ZE55-2400
	TRICKER	04-15 ZE55-2420
	XT250X	06-15 ZE55-2420
	SEROW250	05-15 ZE55-2420

Bike	Year	Part #
K	KLX125, D-TRACKER125	10-16 ZE55-2220
	KLX250, D-TRACKER	93-16 ZE55-2200
S	DRZ400S/SM	00-15 ZE55-2300
	250SB	02-06 ZE55-2200
K	250SX-F	07-10 ZE55-2520
T	250EXC-F/XC-F	08-10 ZE55-2520



CRF250L

CONTROL

BARCLAMP

LEVER

FOOT PARTS

HAND GUARD

BODY GUARD

BODY

ACCESSORIES

CARBON

Take the holeshot!



Light weight 7075-T6 aluminum lock pin

Dust cover

Aluminum sleeve

Easy installation!

Hinge style clamp body and integration of the lower fork guard and lock pin unit for easy installation with no modifications.

ZETA

LAUNCH CONTROL

- A hinge style aluminum clamp body for easy installation.
- The front fork does not need to be removed to install this kit.
- Comes with clamp body and integral lower fork guard. One side only.
- Hinge pin is constructed of high strength Ti-6Al-4V titanium.
- Nylon sleeve prevents front fork scratches.
- Light weight 7075-T6 aluminum lock pin.
- The integration of the lower fork guards and lock pin unit creates a rigid light weight body.
- Currently not available in the US.

	Bike	Year	Natural	Black	White
HONDA	CR85R	03-07	ZE89-7709	ZE89-7705	-
	CRF150R	07-17	ZE89-7709	ZE89-7705	-
	CR125R/250R	04-07	ZE89-7019	-	ZE89-7018
	CRF250R	04-17	ZE89-7019	-	ZE89-7018
	CRF450R	04-16	ZE89-7019	-	ZE89-7018
YAMAHA	YZ85	02-17	ZE89-7709	ZE89-7705	-
	YZ125/250	08-17	-	-	ZE89-7318
	YZ250F	08-17	-	-	ZE89-7318
	YZ450F	08-17	-	-	ZE89-7318
KAWASAKI	KX85	01-13	ZE89-7709	ZE89-7705	-
	KX250F/450F	07-17	-	ZE89-7111	-
SUZUKI	RM85	02-16	ZE89-7709	ZE89-7705	-
	RM-Z250	07-17	-	ZE89-7221	ZE89-7218
	RM-Z450	08-17	-	ZE89-7221	ZE89-7218
KTM	85/105SX	03-17	ZE89-7709	ZE89-7705	-
	125-450SX/SX-F	07-14	-	-	ZE89-7421
		15-17	-	-	ZE89-7433



ZETA

LAUNCH CONTROL UNIVERSAL

- Universal launch control kit to fit most MX racing bikes.
- A hinge style aluminum clamp body for easy installation, no need to remove front fork to install.
- Nylon sleeve on clamp body prevents front fork scratches.
- Hinge pin used on clamp body is made of light weight and durable Ti6Al-4V.
- Lock pin body is fitted by 4 screws for secure installation on your lower fork guard.
- You can install the lock pin body at your desired position on your lower fork guard.
- Replacement rubber for lock pin is available.
- Currently not available in the US.

Part number [ZE89-7000](#)

used by SUZUKI EUROPE WORLD MX2 WGP

FUNCTION



Integrated lower fork guard and lock pin for rigidity and reduced weight.



Nylon sleeve prevents scratches on the front fork. (Excluded on some models.)



Lock pin is made of light weight aluminum A7075-T6.



Hinge style aluminum clamp body for easy installation. Hinge pin is made of light weight, extremely durable titanium, Ti-6Al-4V.

Replacement lower fork guard

Bike	Color	Part #	Dust cover Part number
CR125R/250R, CRF250R '04-	Natural	ZE89-7901	ZE89-7999
CRF450R '04-16	White	ZE89-7902	
KX250F/450F '07-	Black	ZE89-7911	ZE89-7999
	White	ZE89-7921	
RMZ250 '07-, RMZ450 '08-	Black	ZE89-7922	ZE89-7999
YZ125/250, YZ250F/450F '08-	White	ZE89-7931	
KTM 125-450SX/SX-F '07-14	Black	ZE89-7941	ZE89-7999
	White	ZE89-7942	
KTM 125-450SX/SX-F '15-17	White	ZE89-7943	ZE89-7999
	Black	ZE89-7975	
Mini Motocrosser	Natural	ZE89-7979	



ZETA FRONT FORK TOP CAP

- Made of CNC machined 7000 grade aluminum, durable and light weight design.
- Top cap integrated damping adjuster allow you to adjust damping ratio without any tool, quick and easy to adjust.
- Integrated air bleeder on top cap provide more space, no need to worry about air bleeder breakage by hitting handlebar.



Bike	Year	Black	Red	Blue
HONDA				
CR80R/85R	96-07	-	ZE56-10042	-
CRF150R	07-17	-	ZE56-10042	-
CRF250R	15-17	-	ZE56-10082	-
	09-12	ZE56-10020	-	ZE56-10026
CRF450R	13-14	-	ZE56-10062	-
	15-16	-	ZE56-10152	-
XR250	03-07	ZE56-10110	ZE56-10112	-
CRM250R/AR	91-98	-	ZE56-10122	-
CRF250L/M	13-16	-	ZE56-10132	-
YAMAHA				
YZ80/85	93-17	-	-	ZE56-10056
	04	ZE56-10030	-	ZE56-10036
YZ125	06-17	ZE56-10020	-	ZE56-10026
	04	ZE56-10030	-	ZE56-10036
YZ250	06-17	ZE56-10020	-	ZE56-10026
	04	ZE56-10030	-	ZE56-10036
YZ250F	06-17	ZE56-10020	-	ZE56-10026
	04	ZE56-10030	-	ZE56-10036
YZ450F	06-17	ZE56-10020	-	ZE56-10026
YZ125X	17	ZE56-10020	-	ZE56-10026
YZ250X	16-17	ZE56-10020	-	ZE56-10026
YZ250FX	15-17	ZE56-10020	-	ZE56-10026
YZ450FX	16-17	ZE56-10020	-	ZE56-10026
WR250F	05-14	ZE56-10030	-	ZE56-10036
	15-17	ZE56-10020	-	ZE56-10026
WR450F	05-11	ZE56-10030	-	ZE56-10036
	12-17	ZE56-10020	-	ZE56-10026
WR250R/X	07-17	-	-	ZE56-10016
DT200WR	91-94	ZE56-10140	-	-

Bike	Year	Black	Red	Blue
KAWASAKI				
KX80/85	92-17	ZE56-10100	-	-
KX100	95-17	ZE56-10100	-	-
KX125	03-08	ZE56-10030	-	ZE56-10036
KX250	03-04	ZE56-10030	-	ZE56-10036
KX250F	04-05	ZE56-10030	-	ZE56-10036
	06-12	ZE56-10020	-	ZE56-10026
KX450F	13-14	ZE56-10070	-	-
	15-17	ZE56-10090	-	-
KLX450R	07-15	ZE56-10020	-	ZE56-10026
KDX250SR	91-94	ZE56-10110	ZE56-10112	-
KDX250R	91-94	ZE56-10110	ZE56-10112	-
KLX250SR	93-97	ZE56-10110	ZE56-10112	-
KLX250R	93-95	ZE56-10110	ZE56-10112	-
KLX250	98-16	ZE56-10110	ZE56-10112	-
SUZUKI				
RM85	02-16	-	ZE56-10042	-
RM-Z250	04-06	ZE56-10030	-	ZE56-10036
	16-17	ZE56-10160	-	-
RM-Z450	15-16	ZE56-10090	-	-
Husqvarna				
CR150	11	ZE56-10020	-	ZE56-10026
TC250	10-13	ZE56-10020	-	ZE56-10026
TC449	11-13	ZE56-10020	-	ZE56-10026
CR125	10-13	ZE56-10020	-	ZE56-10026
CR450	10	ZE56-10020	-	ZE56-10026
TXC250	10-13	ZE56-10020	-	ZE56-10026
TXC449	11-13	ZE56-10020	-	ZE56-10026
TXC450	10	ZE56-10020	-	ZE56-10026
TXC510	10	ZE56-10020	-	ZE56-10026
TXC511	11-13	ZE56-10020	-	ZE56-10026



ZETA FORK BOTTOM PROTECTOR

- Lower bracket fork protector for KYB front forks.
- Fits inside of lower bracket adjuster area to prevent breakage of bracket edge due to hard rocks hitting edge.
- Made of durable 7000 grade aluminum, blue hard anodized finish.
- Comes in pairs.

Part number
[ZE93-7016](#)

	Bike	Year
H	CRF450R	09-14
	YZ125/250	05-17
	YZ250F/450F	05-17
Y	YZ125X	17
	YZ250X	16-17
	YZ250FX	15-17
	YZ450FX	16-17
K	KX450F	08-14

CONTROL

BARCLAMP

LEVER

FOOT PARTS

HAND GUARD

BODY GUARD

BODY

ACCESSORIES

CARBON



Free Piston		
	Bike	Year
H	CRF450R	09-12
	YZ125/250	06-17
	YZ250F/450F	06-17
Y	YZ125X	17
	YZ250X	16-17
	YZ250FX	15-17
	YZ450FX	16-17
	WR250F	15-17
	WR450F	12-17
	KX450F	07-12
K	KLX450R	07-16
	CR125	10-13
HUSKY	CR150	11
	TC250	10-13
	TC449	11-13
	TC450	10
	TXC250	10-13
	TXC449/511	11-13
	TXC450/510	10

ZETA FREE PISTON for KYB Twin Chamber

- Replacement free piston kit for KYB AOS (Twin chamber) front forks.
- Made of light weight aluminum, more durable than OE free piston.
- Great to use for enduro racing.
- Suspension stiffness can be changed, and to provide progressive suspension feel by changing oil level.

Part number	Size	Description
ZE56-40010	STD	Provides OE suspension feeling.
ZE56-40012	LT	Light weight and less friction design, provides softer and smooth front fork moving.

Front Fork		
	Bike	Year
H	CRF250R (SHOWA)	10-14
	CRF450R	09-12
	YZ125/250/250F	06-17
Y	YZ450F	06
		14-17
	YZ125X	17
	YZ250X	16-17
	YZ250FX	15-17
	YZ450FX	16-17
	WR250F	15-17
K	WR450F	12-17
	KX250	05-08
HUSKY	KX450F	07-12
	KLX450R	07-16
	CR125	10-13
	CR150	11
	TC250	10-13
	TC449	11-13
	TC450	10
	TXC250	10-13
	TXC449/511	11-13
	TXC450/510	10

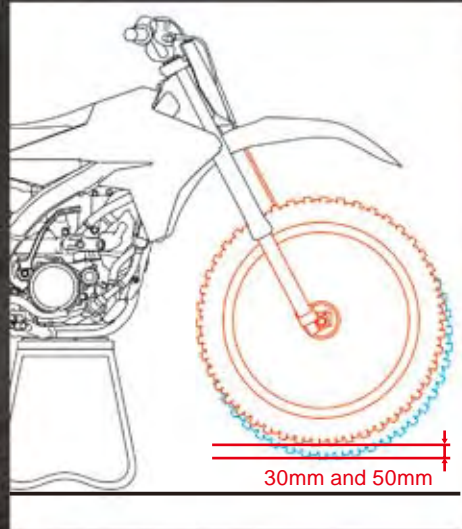

ZETA LOWERING INNER KIT KYB Twin chamber AOS type front fork

- Replace front fork inner parts with this kit. It provides 30 mm and 50 mm lower height.
- Make front fork fully extended length shorter, but no change length when the fork is shortened.
- Keep clearance between wheel and under fender, even on lowering.

Part number	Size
ZE56-31010	KYB AOS -30 mm
ZE56-31030	KYB AOS -50 mm

Rear Suspension		
	Bike	Year
H	CR125R	91-07
	CR250R	91-96
	CRF450R	09-16
Y	YZ125/250	91-17
	YZ250F	01-17
	YZ400-450F	99-17
	YZ125X	17
	YZ250X	16-17
	YZ250FX	15-17
	YZ450FX	16-17
K	WR250F	03-17
	WR400-450F	03-17
HUSKY	KX125/250	91-08
	KX250F	04-05
	KX450F	06-14
	KLX450R	07-15
HY	TC250	12-13
	TC449	11-13
	TXC449/511	11-13
TE250/310	12-13	

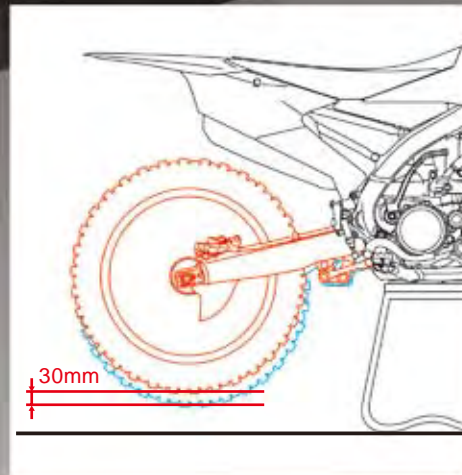

ZETA LOWERING KIT (-30 mm) KYB φ46-50mm rear suspension.

- Replace rear suspension inner part with this kit, provides 30 mm lowering of your rear suspension.
- Great to use for enduro racing.

Part number	Size
ZE56-32110	-30 mm

CONTROL

BARCLAMP

LEVER

FOOT PARTS

HAND GUARD

BODY GUARD

BODY

ACCESSORIES

CARBON

**FRONT
NUMBER
PLATE**

**Light
Weight**

CONTROL

BARCLAMP

LEVER

FOOT PARTS

HAND GUARD

BODY GUARD

BODY

ACCESSORIES

CARBON



**SIDE
COVER**



SHROUD COVER

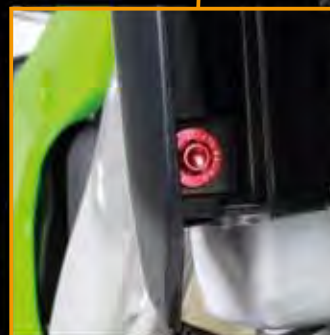

**LOWER
FORK**



ZE88-5666



ZE88-5042

**ZETA
ALUMINUM BOLT KIT**

- Aluminum bolt kit for MX and dual sport bike plastics.
- Made of A7009 T-6 Aluminum, around 50% lighter than stock plastic fastener bolts.
- Kit comes with front number plate, lower fork guards, radiator shrouds and side panel bolts.
- Color anodized finish for corrosion resistance, laser printed logo on flange area.
- Available for most mx racing models and dual sport models.

Bike	Year	Red	Blue
HONDA			
CRF250R	14-17	ZE88-5042	-
CRF450R	13-16	ZE88-5042	-
CRF250L/M	12-16	ZE88-5142	-
YAMAHA			
YZ125/250	08-17	-	ZE88-5646
YZ250F/450F	14-17	-	ZE88-5666
YZ125X	17	-	ZE88-5646
YZ250X	16-17	-	ZE88-5646
YZ250FX	15-17	-	ZE88-5666
YZ450FX	16-17	-	ZE88-5666
KAWASAKI			
KX250F	05-16	ZE88-5242	ZE88-5246
	17	ZE88-5262	ZE88-5266
KX450F	12-15	ZE88-5242	ZE88-5246
	16-17	ZE88-5252	ZE88-5256
KLX250/ D-TRACKER	08-16	ZE88-5342	ZE88-5346
SUZUKI			
RMZ250	10-17	ZE88-5442	ZE88-5446
RMZ450	11-17	ZE88-5442	ZE88-5446
DRZ400SM	05-15	ZE88-5542	ZE88-5546

Fork Guard Bolt	Year	Red	Blue
CR85R/RII	97-07	ZE88-9112	-
CRF150R	07-17	ZE88-9112	-
CR125R/250R	97-07	ZE88-9102 *1	-
CRF250R/X	04-17	ZE88-9102 *1	-
CRF450R	02-17	ZE88-9102 *1	-
CRF450RX	17	ZE88-9102 *1	-
CRF450X	05-16	ZE88-9102 *1	-
CRM250AR	97-98	ZE88-9112	-
CRF250L/M	12-16	ZE88-9112	-
XR250/MOTARD	03-07	ZE88-9112	-
XR400/MOTARD	05-08	ZE88-9112	-
YZ125	91-07	-	ZE88-9416 *2
	08-17	-	ZE88-9406
YZ250	91-07	-	ZE88-9416 *2
	08-17	-	ZE88-9406
YZ250F	01-07	-	ZE88-9416 *2
	08-17	-	ZE88-9406
YZ450F	03-07	-	ZE88-9416 *2
	08-17	-	ZE88-9406
YZ125X	17	-	ZE88-9406
YZ250X	16	-	ZE88-9406
YZ250FX	15-17	-	ZE88-9406
YZ450FX	16-17	-	ZE88-9406
WR250F	01-16	-	ZE88-9416 *2
WR450F	04-16	-	ZE88-9416 *2
WR250R/X	07-17	-	ZE88-9416 *2
KX80/85	98-13		
KX125/250	05-08		
KX250F	05-17	ZE88-9202	ZE88-9206
KX450F	06-17		
KLX450R	08-15		
KLX250/D-TRACKER	98-16		
RMZ250	05-06	ZE88-9202	ZE88-9206
	08-17	ZE88-9302 *2	ZE88-9306 *2
RMZ450	08-17	ZE88-9302 *2	ZE88-9306 *2
RMX450Z	10-16	ZE88-9302 *2	ZE88-9306 *2
250SB	02-06	ZE88-9202	ZE88-9206
DRZ400SM	05-16	-	ZE88-9416 *2
TC85	14-17	-	ZE88-9506
TC125/250	14-17	-	ZE88-9506
TE125-300	14-17	-	ZE88-9506
TX125/300	17	-	ZE88-9506
FC250-450	14-17	-	ZE88-9506
FE250-501	14-17	-	ZE88-9506
FX350/450	17	-	ZE88-9506

*1 CRF bolt kit, ZE88-9102 comes with disc guard bolts.
 *2 Does not come with laser print logo.

Fork Guard Bolt	Year	Orange
50SX	12-17	
65SX	02-17	
85SX	03-17	
KTM125-530SX/SX-F/XC/XC-F	00-17	ZE88-9503
EXC/EXC-F/XC-W/XCF-W	14-17	
FREERIDE 250R	14-17	
FREERIDE 350	12-17	

Oil Filter Cover	Year	Red	Titanium	Blue
CRF150R	07-17	ZE90-1033	-	-
CRF250R	04-09	ZE90-1053	-	-
	10-17	ZE90-1063	-	-
CRF250X	04-17	ZE90-1053	-	-
CRF450R	02-08	ZE90-1073	-	-
	09-16	ZE90-1083	-	-
CRF450X	05-16	ZE90-1073	-	-
CRF250L/M	12-16	ZE90-1023	-	-
XR250/BAJA/MOTARD	95-07	-	ZE90-1010	-
YZ250F	03-13	-	-	ZE90-1352
	14-17	-	-	ZE90-1362
YZ450F	03-09	-	-	ZE90-1352
	10-17	-	-	ZE90-1362
YZ250FX	15-17	-	-	ZE90-1362
YZ450FX	16-17	-	-	ZE90-1362
WR250F	03-14	-	-	ZE90-1352
	15-16	-	-	ZE90-1362
WR450F	03-16	-	-	ZE90-1352
WR250R/X	07-17	-	-	ZE90-1312
KX250F	05-17	ZE90-1153	-	-
KX450F	06-15	ZE90-1173	-	-
	16-17	ZE90-1183	-	-
KLX450R	08-15	ZE90-1173	-	-
KLX125,D-TRACKER125	10-16	ZE90-1193	-	-
KLX150S	09-13	ZE90-1193	-	-
KLX250/D-TRACKER	98-16	-	ZE90-1110	-
RMZ250	05-06	ZE90-1153	-	-
	07-17	ZE90-1253	-	-
RMZ450	05-17	ZE90-1253	-	-
RMX450Z	10-16	ZE90-1253	-	-
250SB	03-06	-	ZE90-1110	-
DRZ400S/SM	00-16	-	ZE90-1210	-

Oil Filter Cover	Year	Orange
250SX-F	05-12	ZE90-1417
	13-17	ZE90-1447
250XC-F	07-12	ZE90-1417
	13-17	ZE90-1447
250EXC-F/XCF-W	07-13	ZE90-1417
250EXC-F	14-17	ZE90-1447
250XCF-W	14-16	ZE90-1447
250EXC-R/EXC-G	00-06	ZE90-1417
350SX-F/EXC-F	11-17	ZE90-1447
350XC-F	11-17	ZE90-1447
350XCF-W	11-16	ZE90-1447
FREERIDE 350	12-17	ZE90-1447
400SX/XC-W/EXC-R	03-07	ZE90-1417
400XC-W	09-10	ZE90-1447
450SX/EXC-R/EXC-G	03-07	ZE90-1417
XC/XC-W		
450EXC/XC-W/XC-F	09-11	ZE90-1447
	09-12	ZE90-1447
450SX-F	13-15	ZE90-1457
	16-17	ZE90-1447
	13-15	ZE90-1457
450XC-F	16-17	ZE90-1447
450EXC	12-16	ZE90-1457
450EXC-F	17	ZE90-1447
500XC-W	12-16	ZE90-1457
500EXC	12-16	ZE90-1457
500EXC-F	17	ZE90-1447
520SX/SXS-R	00-02	ZE90-1417
525SX/SX-R	03-06	ZE90-1417
525EXC-R/XC/XC-W	03-07	ZE90-1417
530EXC/XC-W	09-11	ZE90-1447
450SMR	04-06	ZE90-1417
	09-10	ZE90-1447
525SMR	04-05	ZE90-1417
540SX/SXS-R	00-06	ZE90-1417
950ADVENTURE	03-06	ZE90-1417
990SUPERDUKE	04-06	ZE90-1417

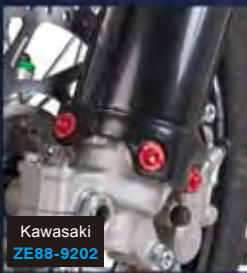

ZETA FORK GUARD BOLT

- Made of light weight aluminum to make front fork bottom area lighter.
- Beautiful anodized color with ZETA laser print logo. (Excluding some part numbers.)
- Available for specific model, not only Japanese, but also KTM and Husqvarna.
- *1 CRF bolt kit, ZE88-9102 comes with disc guard bolts.
- *2 Does not come with laser print logo.



ZETA OIL FILTER COVER

- CNC machined aluminum oil filter covers.
- Made of A7009-T6 aluminum with a beautiful anodized finish and machined "ZETA" logo.
- Lighter than stock oil filter covers.
- Comes with cooling fins for heat dissipation.

CONTROL

BARCLAMP

LEVER

FOOT PARTS

HAND GUARD

BODY GUARD

BODY

ACCESSORIES

CARBON



CRF450R



CRF250R



YZ250F



WR250R/X



CRF250L

ZETA CLUTCH CABLE GUIDE

- CNC machined aluminum clutch cable guide eliminates the flex on stock cable guide.
- Made of A7009-T6 aluminum and light weight design.
- Lighter weight than stock cable guides but stronger than stock guide.
- Exactly the same products used by , SUZUKI Europe, SRM.
- Trail Model.



CRF250L



WR250/X

Bike	Year	Part #
HONDA (Red)		
CRF250R	10-13	ZE94-0111
	14-17	ZE94-0121
CRF450R	09-14	ZE94-0141
	15-16	ZE94-0151
CRF250L/M	12-16	ZE94-0181
YAMAHA (Blue)		
YZ250F	01-13	ZE94-0612
	14-16	ZE94-0622
YZ450F	10-13	ZE94-0662
	14-17	ZE94-0622
YZ250FX	15-17	ZE94-0622
WR250F	01-14	ZE94-0612
	16	ZE94-0622
WR250R/X	07-17	ZE94-0682
KAWASAKI (Red)		
KLX250/D-TRACKER	98-16	ZE94-0381



2014 YZ250F



ZETA TANK HOLD WASHER KIT

- Aluminum washer for holding fuel tank.
- Available colors : titanium, gold, blue and red.
- Installed on your bike with OE bolt and aluminum collar that is contained in the kit.
- Washer is made of A7009-T6 aluminum.

Bike	Year	Blue	Red	Titanium	Gold
HONDA					
CR125R/250R	00-07				
CRF250R	04-17				
CRF450R	02-17	ZE88-0004	ZE88-0005	-	-
CRF450RX	17				
CRF250X	04-17				
CRF450X	05-16				
YAMAHA					
YZ250F	06-09	ZE88-2004	ZE88-2005	ZE88-2006	ZE88-2007
	10-13	ZE88-0004	ZE88-0005	-	-
YZ450F	06-09	ZE88-2004	ZE88-2005	ZE88-2006	ZE88-2007
WR250F	07-14	ZE88-2004	ZE88-2005	ZE88-2006	ZE88-2007
WR450F	07-15	ZE88-2004	ZE88-2005	ZE88-2006	ZE88-2007
WR250R/X	07-17	ZE88-1004	ZE88-1005	-	ZE88-1007
KAWASAKI					
KX65	01-17				
KX85/100	00-17				
KLX110	02-17				
KX125/250	00-08	ZE88-1004	ZE88-1005	-	ZE88-1007
KX250F	04-17				
KX450F	06-17				
KLX450R	08-15				
SUZUKI					
RMZ250	04-06	ZE88-1004	ZE88-1005	-	ZE88-1007
	07-17	ZE88-3004	ZE88-3005	ZE88-3006	ZE88-3007
	05-06	ZE88-1004	ZE88-1005	-	ZE88-1007
RMZ450	07	ZE88-2004	ZE88-2005	ZE88-2006	ZE88-2007
	08-17	ZE88-3004	ZE88-3005	ZE88-3006	ZE88-3007
RMX450Z	10-16	ZE88-3004	ZE88-3005	ZE88-3006	ZE88-3007

ZETA AIR FILTER BOLT

- CNC aluminum air filter bolts.
- Larger rounded head, with finger grooves, makes it easy to spin the filter bolt.
- Red anodized finish with laser printed logo on filter bolt head.
- Bolt shaft is made of durable stainless steel.

Bike	Year	Part #
HONDA		
CR80R	96-02	ZE59-0102
CR85R	03-07	ZE59-0102
CR125R/250R	85-07	ZE59-0202
CR500R	85-01	ZE59-0202
CRF150R	07-17	ZE59-0102
CRF250R/X	04-17	ZE59-0102
CRF250X	04-17	ZE59-0102
CRF450R	02-17	ZE59-0102
CRF450RX	17	ZE59-0102
CRF450X	05-17	ZE59-0102
YAMAHA		
YZ85	02-17	ZE59-0202
YZ125/250	93-17	ZE59-0302
YZ250F	01-13	ZE59-0302
	14-17	ZE59-0402
YZ450F	03-09	ZE59-0302
	14-17	ZE59-0402
YZ125X	17	ZE59-0302
YZ250X	16-17	ZE59-0302
YZ250FX	15-17	ZE59-0402
YZ450FX	16-17	ZE59-0402
WR250F	15-16	ZE59-0402
WR450F	16	ZE59-0402

Bike	Year	Part #
KAWASAKI		
KX65	00-17	
KX80/85	91-17	
KX100	95-17	
KX125	92-05	ZE59-0202
KX250	92-08	
KX250F	04-17	
KX450F	06-17	
SUZUKI		
RM125	96-08	
RM250	93-08	
RM-Z250	07-17	ZE59-0302
RM-Z450	05-17	

CONTROL

BARCLAMP

LEVER

FOOT PARTS

HAND GUARD

BODY GUARD

BODY

ACCESSORIES

CARBON

Racer	Year	Red	Blue	Black
H	CRF50F	04-17	ZE87-2403	-
	CR85R	00-07	ZE87-0303	-
	CRF125F	14-17	ZE87-2403	-
	CRF150R	07-17	ZE87-0303	-
	CRF250R	04-17	ZE87-0603	ZE87-0600
	CRF450R	02-17	ZE87-0603	ZE87-0600
	CRF450RX	17	ZE87-0603	ZE87-0600
	XR250R	96-	ZE87-0603	ZE87-0600
Y	YZ85	04-17		
	YZ125/250	04-17		
	YZ250F	04-13	ZE87-1503	ZE87-1501
	YZ450F	04-13		
	YZ125X	17		
	YZ250X	16-17		
K	KX65	06-17	ZE87-2403	-
	KX85/100	06-13	ZE87-2403	-
		14-17	ZE87-1503	ZE87-1501
	KLX110	06-09	ZE87-2403	-
	KLX110L	10-17	ZE87-1503	ZE87-1501
	KX125	06-08	ZE87-2403	-
	KX250	05-08	ZE87-1503	ZE87-1501
		04-05	ZE87-2403	-
	KX250F	06-17	ZE87-1503	ZE87-1501
	KX450F	06-17	ZE87-1503	ZE87-1501
	KLX450R	08-15	ZE87-1503	ZE87-1501
	KFX450R	08-	ZE87-1503	ZE87-1501
S	DR-Z50/70	08-13	ZE87-2503	ZE87-2501
	RM85	05-16	ZE87-2303	-
	RM125/250	04-08	ZE87-2303	-
		04-06	ZE87-2403	-
	RMZ250	07-09	ZE87-2503	ZE87-2501
		10-17	ZE87-2303	-
	RMZ450	05-17	ZE87-2303	-
	RMX450Z	10-16	ZE87-2303	-
	LT-R450	06-09	ZE87-2503	ZE87-2501
	LT-Z400/Z	03-09	ZE87-2503	ZE87-2501
LT-Z250	04-09	ZE87-2503	ZE87-2501	
Hsky	TC85	14-17	-	ZE87-4102
	WR125	08-12	ZE87-2503	ZE87-2501
	TC125	14-15	-	ZE87-4102
	TC250	09-13	ZE87-2503	ZE87-2501
		14-16	-	ZE87-4102
	TE250	09-13	ZE87-2503	ZE87-2501
	FC250-450	14-15	-	ZE87-4102
	TE/FE125-501	14-17	-	ZE87-4202
	TX/FX125-450	17	-	ZE87-4202
	SM250R	09	ZE87-2503	ZE87-2501
IMS	ALL	-	ZE87-0603	ZE87-0600

Installed on KTM

ZE87-4208

ZE87-4202

ZE87-4108

ZE87-4102

ZETA GAS CAP

- CNC machined aluminum gas cap.
- Beautiful anodized color makes your bike the Factory look.
- Comes with uni flow cap which prevents fuel back flow from the fuel tank in the event of a fall.
- Made of A7009-T6 aluminum.
- Available in Blue, Red, Orange and Black colors.

Racer	Year	Orange
65SX	10-17	ZE87-4208
125-450SX/SX-F	11-12	ZE87-4208
85-450SX/SX-F	13-17	ZE87-4108
125-530EXC/EXC-F /XC/XC-F/XC-W/XCF-W	11-17	ZE87-4208

Dual Sports	Year	Blue	Titanium
CRM50/80	88-99	ZE87-5101	ZE87-5106
CRM250R/AR	89-00	ZE87-5101	ZE87-5106
XR230/MOTARD	05-12	ZE87-5101	ZE87-5106
XR250/MOTARD	95-07	ZE87-5101	ZE87-5106
XR400/MOTARD	05-08	ZE87-5101	ZE87-5106
XLR250R/BAJA	87-94	ZE87-5101	ZE87-5106
DT200WR	91-94	ZE87-6101	ZE87-6106
DT230LANZA	97-99	ZE87-6101	ZE87-6106
SEROW225	93-04	ZE87-6101	ZE87-6106
TT250R	93-97	ZE87-6101	ZE87-6106
WR250R/X	07-17	ZE87-6101	ZE87-6106
KSR110	03-08	ZE87-7101	ZE87-7106
KLX125, D-TRACKER125	10-16	ZE87-7101	ZE87-7106
KLX150S	09-13	ZE87-7101	ZE87-7106
KLX250, D-TRACKER	01-16	ZE87-7101	ZE87-7106
SUPER SHERPA	97-07	ZE87-7101	ZE87-7106
250SB	02-06	ZE87-7101	ZE87-7106
RMX250S	92-95	ZE87-6101	ZE87-6106
DRZ400S/SM	00-16	ZE87-6101 #	ZE87-6106 #

#Can not be used for US Californian models.

Installed on WR250X

ZE87-7106

ZETA GAS CAP TRAIL

- CNC machined aluminum gas cap for dual sport and trail models.
- Easy to install, just replace the stock fuel outer caps.
- KLX and D-TRACKER can be installed with factory key lock. Other models come with uni flow caps.
- Available in Blue and Titanium colors.

ZETA UNI-FLOW CAP

- One way valve to prevent fuel back flow from the fuel tank in the event of a fall.
- Keeps the fuel tank air ventilated but does not let fuel flow out.
- Available in 5 beautiful anodized colors.
- Cap is made of A7009-T6 aluminum.

Part number	Color
ZE93-1001	Blue
ZE93-1003	Red
ZE93-1006	Titanium
ZE93-1007	Gold
ZE93-1010	Orange



Installed on CRF450R

CONTROL

BARCLAMP

LEVER

FOOT PARTS

HAND GUARD

BODY GUARD

BODY

ACCESSORIES

CARBON



**SUZUKI EUROPE WORLD MX2
WGP**



**ZETA
ENGINE PLUG**

- CNC machined engine plugs.
- Replaces stock plugs to give a factory bike look.
- Available in anodized colors of red, blue and orange for KTM.
- Laser printed ZETA logo.



**ZETA
OIL FILLER PLUG**

- CNC machined oil filler cap.
- 14 mm hex head design for easy operation with a wrench.
- Includes safety wire holes to prevent mispaced part.
- Available in anodized colors of red, blue and orange for KTM.
- Laser printed ZETA logo.



**ZETA
OIL DIP STICK**

- CNC machined oil filler cap with aluminum oil dipstick.
- Includes safety wire holes to prevent mispaced part.
- Available in anodized colors of red.
- Laser printed ZETA logo.

	Oil Dip Stick	Year	Red
HONDA	CRF150R	07-17	ZE89-3050
	CRF250R	04-09	ZE89-3020
	CRF250X	10-17	ZE89-3040
	CRF450R	04-17	ZE89-3020
	CRF450X	09-16	ZE89-3030
SUZUKI	DR-Z400R/S/SM	05-16	ZE89-3020

	Engine Plug	Year	Red	Blue
HONDA	CRF150R	07-17	ZE89-1120	-
	CRF250R	04-09	ZE89-1110	-
	CRF250X	10-17	ZE89-1120	-
	CRF450R	04-17	ZE89-1110	-
	CRF450X	02-16	ZE89-1120	-
	CRF450X	05-16	ZE89-1120	-
	CRF250L/M	12-16	ZE89-1150	-
	XR250/Baja/Motard	95-07	ZE89-1120	-
	XR400/Motard	05-08	ZE89-1120	-
	TRX400EX	00-08	ZE89-1120	-
TRX450R/ER	04-09	ZE89-1120	-	
YAMAHA	TT-R50	06-15	ZE89-1410	ZE89-1412
	YZ250F	01-13	ZE89-1410	ZE89-1412
		14-17	ZE89-1440	ZE89-1442
		06-09	ZE89-1420	ZE89-1422
	YZ450F	10-13	ZE89-1430	ZE89-1432
		14-17	ZE89-1440	ZE89-1442
	YZ400F/426F/450F	98-05	ZE89-1410	ZE89-1412
	YZ250FX	15-17	ZE89-1440	ZE89-1442
	YZ450FX	16-17	ZE89-1440	ZE89-1442
		01-02	ZE89-1410	ZE89-1412
	WR250F	03-14	ZE89-1420	ZE89-1422
		15-16	ZE89-1440	ZE89-1442
WR400F/426F	98-02	ZE89-1410	ZE89-1412	
WR450F	03-16	ZE89-1420	ZE89-1422	
WR250R/X	07-17	ZE89-1410	ZE89-1412	
SEROW250	05-16	ZE89-1410	ZE89-1412	
TRICKER	04-16	ZE89-1410	ZE89-1412	
XT250X	06-16	ZE89-1410	ZE89-1412	
YFZ450	04-09	ZE89-1420	ZE89-1422	
Kawasaki	KX250F	04-10	ZE89-1210	ZE89-1212
		11-17	ZE89-1230	ZE89-1232
	KX450F	06-08	-	ZE89-1222
		09-17	ZE89-1230	ZE89-1232
	KLX450R	08-15	ZE89-1230	ZE89-1232
	KLX125, D-TRACKER125	10-16	ZE89-1280	ZE89-1282
KLX150S	09-13	ZE89-1280	ZE89-1282	
KLX250, D-TRACKER	98-16	ZE89-1250	ZE89-1252	
KFX400	03-06	ZE89-1350	ZE89-1352	
SUZUKI	RMZ250	04-06	ZE89-1210	ZE89-1212
		07-17	ZE89-1310	ZE89-1312
	RMZ450	05-17	ZE89-1310	ZE89-1312
	RMX450Z	10-16	ZE89-1310	ZE89-1312
	DR-Z400R/S/SM	00-16	ZE89-1350	ZE89-1352
250SB	02-06	ZE89-1250	ZE89-1252	
Husky	FC250/350	14-17	-	ZE89-1612
	FE250/350	14-17	-	ZE89-1612
	FX350	17	-	ZE89-1612
KTM	Engine Plug	Year	Orange	
	250SX-F	11-17		
	250XC-F	11-17		
	250XCF-W	12-16		
	250EXC-F	12-17		
	350SX-F	11-17		
	350XC-F	12-17		
	350XCF-W	12-16		
	350EXC-F	12-17		
	FREERIDE 350	14-17		
	450SX-F	07-12		
	450XC-F	08-09		
	450SMR	08-10		
	505SX-F/XC-F	08-09		

	Oil Filler Plug	Year	Red	Blue
HONDA	CRF150R	07-17		
	CR125R/250R	90-07		
	CRF250R	04-17		
	CRF450R	02-16	ZE89-2110	ZE89-2112
	CRF450X	05-16		
	CRM250R/AR	89-98		
	CRF250L/M	12-16		
	TRX450R/RX	04-09		
	YZ80/85	98-17	ZE89-2110	ZE89-2112
YZ125	97-17	ZE89-2110	ZE89-2112	
YZ250	99-17	ZE89-2110	ZE89-2112	
YZ250F	01-17	ZE89-2110	ZE89-2112	
YZ450F	03-17	ZE89-2110	ZE89-2112	
YZ125X	17	ZE89-2110	ZE89-2112	
YZ250X	16-17	ZE89-2110	ZE89-2112	
YZ250FX	15-17	ZE89-2110	ZE89-2112	
YZ450FX	16-17	ZE89-2110	ZE89-2112	
Kawasaki	WR250F	03-16	ZE89-2110	ZE89-2112
	WR450F	03-16	ZE89-2110	ZE89-2112
	WR250R/X	07-17	ZE89-2110	ZE89-2112
	SEROW225	99-04	ZE89-2110	ZE89-2112
	SEROW250	05-16	ZE89-2210	ZE89-2212
	TRICKER	04-16	ZE89-2210	ZE89-2212
	XT250X	06-16	ZE89-2210	ZE89-2212
	YFZ450	04-09	ZE89-2110	ZE89-2112
	KX250	05-08	ZE89-2310	ZE89-2312
	KX250F	04-17	ZE89-2310	ZE89-2312
KX450F	06-17	ZE89-2310	ZE89-2312	
KLX450R	08-15	ZE89-2310	ZE89-2312	
KLX250	93-16	ZE89-2110	ZE89-2112	
D-TRACKER	98-16	ZE89-2110	ZE89-2112	
KFX450R	08-09	ZE89-2310	ZE89-2312	
SUZUKI	RM80/85	01-16	ZE89-2210	ZE89-2212
	RM125/250	01-08	ZE89-2210	ZE89-2212
	RM-Z250	04-06	ZE89-2310	ZE89-2312
		07-17	ZE89-2210	ZE89-2212
	RM-Z450	05-17	ZE89-2210	ZE89-2212
	RMX450Z	10-16	ZE89-2210	ZE89-2212
	250SB	02-06	ZE89-2110	ZE89-2112
LT-R450	06-09	ZE89-2210	ZE89-2212	
Husky	TC85	14-17	-	ZE89-2412
	TC125	14-17	-	ZE89-2412
	TC250	09-13	ZE89-2310	ZE89-2312
		14-17	-	ZE89-2412
	TE125	14-16	-	ZE89-2412
	TE250	09-13	ZE89-2310	ZE89-2312
		14-17	-	ZE89-2412
	TE300	14-17	-	ZE89-2412
	TX125/300	17	-	ZE89-2412
	FC250-450	14-17	-	ZE89-2412
FE250-501	14-17	-	ZE89-2412	
FX350/450	17	-	ZE89-2412	
SM250R	09	ZE89-2310	ZE89-2312	

	Oil Filler Plug	Year	Orange
KTM	50-300 2st	-	ZE89-2416
	250-690 4st	-	ZE89-2416

ZETA BRAKE RESERVOIR COVER

- Made of CNC machined A7009-T6 aluminum.
- Anodized finish colors. Available in red, blue, orange for KTM.
- Available for MX, ED and dual sport bikes.

Brake Reservoir Cover Front
Clutch Reservoir Cover Front
Brake Reservoir Cover Rear

YUTA IKEGAYA JMX

Brake Reservoir Cover Front	Year	Red	Blue
HONDA			
CR80R/85R	98-07	ZE86-1103	-
CRF125F	14-17	ZE86-1103	-
CRF150R	07-17	ZE86-1103	-
CR125R/250R	96-07	ZE86-1103	-
CRF250R/X	04-17	ZE86-1103	-
CRF450R	02-17	ZE86-1103	-
CRF450RX	17	ZE86-1103	-
CRF450X	05-17	ZE86-1103	-
XR50/XR100MOTARD	05-08	ZE86-1503	ZE86-1501
CRM50/80	88-98	ZE86-1503	ZE86-1501
FTR223	00-08	ZE86-1503	ZE86-1501
SL230	97-05	ZE86-1503	ZE86-1501
XR230/MOTARD	05-12	ZE86-1503	ZE86-1501
CRM250R/AR	89-98	ZE86-1503	ZE86-1501
CRF250L/M	12-16	ZE86-1503	ZE86-1501
XR250/MOTARD	95-07	ZE86-1503	ZE86-1501
XR400MOTARD	05-07	ZE86-1503	ZE86-1501
TRX450R	04-09	ZE86-1503	ZE86-1501
TRX450ER	06-09	ZE86-1503	ZE86-1501
TRX400EX	99-08	ZE86-1503	ZE86-1501
TRX300EX	93-08	ZE86-1503	ZE86-1501
YAMAHA			
YZ85	03-17	ZE86-2103	ZE86-2101
YZ125/250	02-07	ZE86-2103	ZE86-2101
	08-17	ZE86-2303	ZE86-2301
YZ250F	02-06	ZE86-2103	ZE86-2101
	07-17	ZE86-2303	ZE86-2301
YZ426F-450F	02-07	ZE86-2103	ZE86-2101
	08-17	ZE86-2303	ZE86-2301
YZ125X	16-17	ZE86-2303	ZE86-2301
YZ250X	15-17	ZE86-2303	ZE86-2301
YZ250FX	16-17	ZE86-2303	ZE86-2301
YZ450FX	16-17	ZE86-2303	ZE86-2301
WR250F	02-16	ZE86-2103	ZE86-2101
WR250F	04-15	ZE86-2103	ZE86-2101
WR450F	16	ZE86-2303	ZE86-2301
TRICKER	04-16	ZE86-1503	ZE86-1501
SEROW250	05-16	ZE86-1503	ZE86-1501
XT250X	06-16	ZE86-1503	ZE86-1501
WR250R/X	07-17	ZE86-1503	ZE86-1501
YFZ450	07-10	ZE86-1503	ZE86-1501
RAPTOR250	08	ZE86-1503	ZE86-1501
RAPTOR700	07-10	ZE86-1503	ZE86-1501
KAWASAKI			
KX65	01-17	ZE86-2103	ZE86-2101
KX80/85/100	98-17	ZE86-2103	ZE86-2101
KX125	92-08	ZE86-2103	ZE86-2101
KX250	93-08	ZE86-2103	ZE86-2101
KX250F	04-17	ZE86-2103	ZE86-2101
KX450F	06-17	ZE86-2103	ZE86-2101
KSR50/80/110	94-08	ZE86-1503	ZE86-1501
KDX125	92-99	ZE86-1503	ZE86-1501
KDX220	94-99	ZE86-1503	ZE86-1501
KDX250	92-94	ZE86-1503	ZE86-1501
KLX125	10-16	ZE86-1503	ZE86-1501
KLX150S	09-13	ZE86-1503	ZE86-1501
KLX250/300	93-16	ZE86-1503	ZE86-1501
KLX450R	08-15	ZE86-2103	ZE86-2101
D-TRACKER125	10-16	ZE86-1503	ZE86-1501
D-TRACKER	98-16	ZE86-1503	ZE86-1501
KFX450R	08-09	ZE86-1503	ZE86-1501
KFX700	04-09	ZE86-1503	ZE86-1501
SUZUKI			
RM80/85	94-16	ZE86-2103	ZE86-2101
RM125/250	04-08	ZE86-2103	ZE86-2101
RMZ250	04-17	ZE86-2103	ZE86-2101
RMZ450	05-17	ZE86-2103	ZE86-2101
RMX450Z	10-16	ZE86-2103	ZE86-2101
RMX250S	89-98	ZE86-1503	ZE86-1501
DR250R/DJEBEL250XC	95-06	ZE86-1503	ZE86-1501
250SB	02-06	ZE86-1503	ZE86-1501
DRZ400S/SM	00-16	ZE86-1503	ZE86-1501
LT-R450	06-09	ZE86-1503	ZE86-1501
LT-Z400/Z	03-08	ZE86-1503	ZE86-1501
LT-Z250	04-08	ZE86-1503	ZE86-1501
HUSQVARNNA			
TC85	14-17	-	ZE86-3202
TC/TE/TX/FC/FE/	14-17	-	ZE86-1302
FX125-501/S	16-17	-	ZE86-1302
FR450RALLY	16-17	-	ZE86-1302

Brake Reservoir Cover Front	Year	Orange
KTM		
65SX	14-16	ZE86-3210
85SX	13-17	ZE86-3210
125SX/XC-W/EXC(SIX DAYS)	05-17	ZE86-1310
144/150SX/150XC/150XC-W	05-17	ZE86-1310
200XC-W/EXC	05-16	ZE86-1310
250SX/SX-F/XC-F	05-17	ZE86-1310
250XC/XC-W/XCF-W	05-17	ZE86-1310
250EXC/EXC-R/EXC-F (SIX DAYS)	05-17	ZE86-1310
300XC/XC-W/EXC(SIX DAYS)	05-17	ZE86-1310
350SX-F/XC-F/XCF-W	11-17	ZE86-1310
350EXC-F(SIX DAYS)	11-17	ZE86-1310
400XC-W/EXC/EXC-R	05-11	ZE86-1310
450SX/SX-R/SX-F	05-17	ZE86-1310
450XC/XC-F/XC-R	05-17	ZE86-1310
450XC-W/EXC-R/EXC/EXC-F (SIX DAYS)	05-17	ZE86-1310
500XC-W/EXC/EXC-F (SIX DAYS)	12-17	ZE86-1310
505SX-F/XC-F	08-09	ZE86-1310
525SX/SX-R/XC/XC-W/EXC-R	05-07	ZE86-1310
530XC-W/XCR-W/EXC-R/EXC	08-11	ZE86-1310
450SMR	13	ZE86-3210
FREERIDE 250R	14-17	ZE86-3210
FREERIDE 350	12-17	ZE86-3210
FREERIDE E-SX/XC/SM	15-16	ZE86-3210
450RALLY	13-17	ZE86-1310

Clutch Reservoir Cover Front	Year	Orange
KTM		
65SX	14-16	ZE86-3110
85SX	13-17	ZE86-3110
125EXC (SIX DAYS)	09-16	ZE86-1410
125/144SX	09-15	ZE86-1410
125SX/XC-W	16-17	ZE86-1310
150SX/XC	09-15	ZE86-1410
150SX/XC-W	16-17	ZE86-1310
200EXC/XC/XC-W	09-15	ZE86-1410
200EXC	16	ZE86-1310
250EXC/EXC-F (SIX DAYS)	06-17	ZE86-1310
250SX-F	07-17	ZE86-1310
250SX	06-17	ZE86-1310
250XC	06-17	ZE86-1310
250XC-F	07-17	ZE86-1310
250XCF-W	07-16	ZE86-1310
250/300XC-W	06-17	ZE86-1310
300EXC (SIX DAYS)	06-17	ZE86-1310
300XC	06-17	ZE86-1310
350EXC-F/SIX DAYS	11-17	ZE86-1310
350SX-F/XC-F/XCF-W	11-17	ZE86-1310
400EXC	09-11	ZE86-1310
400XC-W	09-10	ZE86-1310
450EXC/R/EXC-F (SIX DAYS)	07-17	ZE86-1310
450SMR	09	ZE86-1410
	13-14	ZE86-1310
450SX/SX-F/SX-R	09-12	ZE86-1410
	13-17	ZE86-1310
450XC-F	08	ZE86-1310
450XC-W/XCR-W (SIX DAYS)	08-16	ZE86-1310
500EXC/XC-W/EXC-F (SIX DAYS)	12-17	ZE86-1310
505XC-F	08	ZE86-1310
525EXC-R	07	ZE86-1310
530EXC-/EXC-R/XCR-W/XC-W (SIX DAYS)	08-11	ZE86-1310
FREERIDE 250R	14-17	ZE86-3110
FREERIDE 350	12-17	ZE86-3110
FREERIDE E-SX/XC/SM	15-16	ZE86-3110
450RALLY	15-17	ZE86-1310

Clutch Reservoir Cover Front	Year	Blue
HUSQVARNNA		
TC85	14-17	ZE86-3102
TC125/250	14-17	ZE86-1402
TE125	14-16	ZE86-1402
TE150	17	ZE86-1402
TE250/300	14-16	ZE86-1302
	17	ZE86-1402
FC250-450	14-15	ZE86-1302
	16-17	ZE86-1402
FE250-501/S	14-16	ZE86-1302
	17	ZE86-1402
FR450RALLY	16-17	ZE86-1302
FS450	15	ZE86-1302
	16-17	ZE86-1402
TX125-300	17	ZE86-1402
FX350-450	17	ZE86-1402

Brake Reservoir Cover Rear	Year	Red	Blue
HONDA			
CRF150R	07-17	ZE86-4103	-
CR125R/250R	02-07	ZE86-4103	-
CRF250R/X	04-17	ZE86-4103	-
CRF450R	02-17	ZE86-4103	-
CRF450RX	17	ZE86-4103	-
CRF450X	05-17	ZE86-4103	-
CRF250L/M	12-16	ZE86-1103	-
TRX300EX	93-08	ZE86-1503	ZE86-1501
YAMAHA			
YZ125/250	03-17	ZE86-5103	ZE86-5101
YZ250F/450F	03-17	ZE86-5103	ZE86-5101
YZ125X	17	ZE86-5103	ZE86-5101
YZ250X	16-17	ZE86-5103	ZE86-5101
YZ250FX	15-17	ZE86-5103	ZE86-5101
YZ450FX	16-17	ZE86-5103	ZE86-5101
WR250F	03-17	ZE86-5103	ZE86-5101
WR450F	04-17	ZE86-5103	ZE86-5101
WR250R/X	07-17	ZE86-5103	ZE86-5101
TRICKER	04-16	ZE86-5103	ZE86-5101
SEROW250	05-16	ZE86-5103	ZE86-5101
XT250X	06-16	ZE86-5103	ZE86-5101
KAWASAKI			
KX125/250	03-08	ZE86-6103	ZE86-6101
KX250F	04-17	ZE86-6103	ZE86-6101
KX450F	06-17	ZE86-6103	ZE86-6101
KLX125-D-TRACKER125	10-16	ZE86-2103	ZE86-2101
KLX150S	09-13	ZE86-2103	ZE86-2101
KLX250/300	93-16	ZE86-2103	ZE86-2101
KLX450R	08-15	ZE86-6103	ZE86-6101
KFX450R	08-10	ZE86-6103	ZE86-6101
SUZUKI			
RM125/RM250	04-08	ZE86-6103	ZE86-6101
RMZ250	04-17	ZE86-6103	ZE86-6101
RMZ450	05-17	ZE86-6103	ZE86-6101
RMX450Z	10-16	ZE86-6103	ZE86-6101
DRZ400S/SM	00-16	ZE86-2103	ZE86-2101
HUSQVARNNA			
TC85	14-17	-	ZE86-7202
TC125/250	14-17	-	ZE86-7102
TE125-300	14-17	-	ZE86-7102
TX125/300	17	-	ZE86-7102
FC250-450	14-17	-	ZE86-7102
FE250-501	14-17	-	ZE86-7102
FX350/450	17	-	ZE86-7102

Brake Reservoir Cover Rear	Year	Orange
KTM		
85SX/SXS/XC	03-17	ZE86-7210
65SX/SXS/XC	04-17	ZE86-7210
50SXS	11-13	ZE86-7210
50SX/SXS/SM	06-17	ZE86-7210
105SX/XC	04-11	ZE86-7210
125-530 SX/SX-F/EXC/EXC-F/XC/	04-17	ZE86-7110
XC-F/XC-W/XCF-W/SMR	14-17	ZE86-7210
FREERIDE 250R	14-17	ZE86-7210
FREERIDE 350	12-17	ZE86-7210

Brake Reservoir Cover Rear	Year	Orange
KTM		
85SX/SXS/XC	03-17	ZE86-7210
65SX/SXS/XC	04-17	ZE86-7210
50SXS	11-13	ZE86-7210
50SX/SXS/SM	06-17	ZE86-7210
105SX/XC	04-11	ZE86-7210
125-530 SX/SX-F/EXC/EXC-F/XC/	04-17	ZE86-7110
XC-F/XC-W/XCF-W/SMR	14-17	ZE86-7210
FREERIDE 250R	14-17	ZE86-7210
FREERIDE 350	12-17	ZE86-7210

HIGH PERFORMANCE PRODUCTS

DIRT

CONTROL

BARCLAMP

LEVER

FOOT PARTS

HAND GUARD

BODY GUARD

BODY

ACCESSORIES

CARBON

ZETA FORK TOP BLEEDER

- Allows bleeding of air pressure without additional tools.
- Easy to install. Replace the OEM bleeder screw with the Fork Top Bleeder.
- Fits most KAYABA and Showa upside-down forks. (Excluding KX250F '11-, YZ85, RMZ250/450 '13-)
- Available bleeder for KTM / HUSKY / WP Suspension.
- Colors available (Anodized) : Blue, Red and Titanium.
- Blue, Orange and titanium for KTM / HUSKY / WP.
- Comes in pairs.

Part number	Description	Color
ZE91-1103	SHOWA / KYB	Titanium
ZE91-1106	SHOWA / KYB	Red
ZE91-1107	SHOWA / KYB	Blue
ZE91-4102	KTM / HUSKY/ WP	Blue
ZE91-4103	KTM / HUSKY/ WP	Titanium
ZE91-4107	KTM / HUSKY/ WP	Orange



ZETA REAR BRAKE CLEVIS

- The high rigid and light weight design, provides better control of the rear brake.
- Clevis body is made of A7009-T6 aluminum.
- Comes with a specially designed stainless steel pin.
- Available in red and blue anodized colors.



ZETA BRAKE LINE CLAMP

- Light weight and durable brake line clamp.
- Strongly clamp your brake line while reducing bike weight.
- Available in red and blue anodized colors.
- Made of A7009-T6 aluminum.



Rear Brake Clevis	Year	Red	Blue
HONDA			
CR80R/85R	96-07	ZE89-5045	-
CRF150R	07-17	ZE89-5015	ZE89-5014
CR125R/250R	02-07	ZE89-5015	ZE89-5014
CRF250R/X	04-17	ZE89-5015	ZE89-5014
CRF450R	02-17	ZE89-5015	ZE89-5014
CRF450RX	17	ZE89-5015	ZE89-5014
CRF450X	05-16	ZE89-5015	ZE89-5014
XR50/XR100MOTARD	05-07	ZE89-5045	-
XR230/MOTARD	05-12	ZE89-5045	-
CRM250R/AR	89-98	ZE89-5045	-
CRF250L/M	12-16	ZE89-5045	-
XR250/MOTARD	95-07	ZE89-5045	-
XR400MOTARD	05-08	ZE89-5045	-
XR650R	00-07	ZE89-5045	-
TRX450R/ER	04-09	ZE89-5045	-
TRX400EX	00-08	ZE89-5045	-
YAMAHA			
YZ80/85	94-17	ZE89-5035	ZE89-5034
YZ125/250	03-17	ZE89-5135	ZE89-5134
YZ250F/450F	03-17	ZE89-5135	ZE89-5134
YZ125X	17	ZE89-5135	ZE89-5134
YZ250X	16-17	ZE89-5135	ZE89-5134
YZ250FX	15-17	ZE89-5135	ZE89-5134
YZ450FX	16-17	ZE89-5135	ZE89-5134
WR250F/450F	03-16	ZE89-5135	ZE89-5134
SEROW225W/WE	93-04	ZE89-5035	ZE89-5034
SEROW250	05-16	ZE89-5035	ZE89-5034
TRICKER	04-16	ZE89-5035	ZE89-5034
XT250X	06-16	ZE89-5035	ZE89-5034
WR250R/X	07-17	ZE89-5155	ZE89-5154
YFZ450	04-10	ZE89-5035	ZE89-5034
RAPTER700R	06-09	ZE89-5035	ZE89-5034
RAPTER660R	01-05	ZE89-5035	ZE89-5034
RAPTER350	04-09	ZE89-5035	ZE89-5034
KAWASAKI			
KX65	03-17	ZE89-5125	ZE89-5124
KX80/85/100	98-17	ZE89-5115	ZE89-5114
KX125	02	ZE89-5125	ZE89-5124
	03-08	ZE89-5115	ZE89-5114
KX250	03-04	ZE89-5115	ZE89-5114
	05-08	ZE89-5125	ZE89-5124
KX250F	04-17	ZE89-5125	ZE89-5124
KX450F	06-17	ZE89-5125	ZE89-5124
KLX125	10-16	ZE89-5115	ZE89-5114
KLX150S	09-13	ZE89-5115	ZE89-5114
KLX250	93-16	ZE89-5115	ZE89-5114
KLX450R	08-15	ZE89-5125	ZE89-5124
D-TRACKER125	10-16	ZE89-5115	ZE89-5114
D-TRACKER	98-16	ZE89-5115	ZE89-5114
KFX450R	08-10	ZE89-5125	ZE89-5124
SUZUKI			
RM80/85	98-16	ZE89-5115	ZE89-5114
RM125/250	01-13	ZE89-5115	ZE89-5114
RMZ250	04-06	ZE89-5125	ZE89-5124
RMZ450	07-17	ZE89-5135	ZE89-5134
	05-17	ZE89-5135	ZE89-5134
RMX450Z	10-16	ZE89-5135	ZE89-5134
RMX250S/R	93-98	ZE89-5115	ZE89-5114
DRZ400S/R	00-09	ZE89-5115	ZE89-5114
DRZ400SM	04-16	ZE89-5115	ZE89-5114
250SB	02-06	ZE89-5115	ZE89-5114
LT-R450	06-09	ZE89-5115	ZE89-5114

Brake Line Clamp	Year	Red	Blue
HONDA			
CR80R/85R	96-07	ZE92-0106	ZE92-0107
CRF150R	07-17	ZE92-0106	ZE92-0107
CR125R/250R	90-03	ZE92-0106	ZE92-0107
CRF250R	04-07	ZE92-0206	ZE92-0207
CRF250X	06-17	ZE92-0206	ZE92-0207
CRF450R	02-03	ZE92-0106	ZE92-0107
CRF450RX	04-17	ZE92-0206	ZE92-0207
CRF450X	17	ZE92-0206	ZE92-0207
CRF450X	05-16	ZE92-0206	ZE92-0207
CRM250R/AR	91-98	ZE92-0106	ZE92-0107
CRF250L/M	12-16	ZE92-0206	ZE92-0207
XR250/BAJA/MOTARD	95-07	ZE92-0106	ZE92-0107
XR400MOTARD	05-08	ZE92-0106	ZE92-0107
YAMAHA			
YZ125/250	05-08	ZE92-4106	ZE92-4107
	09-17	ZE92-0206	ZE92-0207
YZ250F	05-08	ZE92-4106	ZE92-4107
	09-17	ZE92-0206	ZE92-0207
YZ450F	05-08	ZE92-4106	ZE92-4107
	09-17	ZE92-0206	ZE92-0207
YZ125X	17	ZE92-0206	ZE92-0207
YZ250X	16-17	ZE92-0206	ZE92-0207
YZ250FX	15-17	ZE92-0206	ZE92-0207
YZ450FX	16-17	ZE92-0206	ZE92-0207
WR250F/450F	05-16	ZE92-4106	ZE92-4107
WR250R/X	07-17	ZE92-4106	ZE92-4107
KAWASAKI			
KX65	00-17	ZE92-2106	ZE92-2107
KX80/85/100	89-17	ZE92-2106	ZE92-2107
KX125/250	92-08	ZE92-2106	ZE92-2107
KX250F	04-17	ZE92-2106	ZE92-2107
KX450F	06-17	ZE92-2106	ZE92-2107
KLX450R	08-15	ZE92-2106	ZE92-2107
KLX125,D-TRACKER125	10-16	ZE92-2106	ZE92-2107
SUZUKI			
RM85	02-16	ZE92-2106	ZE92-2107
RM125/250	01-13	ZE92-2106	ZE92-2107
RMZ250	04-17	ZE92-2106	ZE92-2107
RMZ450	05-17	ZE92-2106	ZE92-2107
RMX450Z	10-16	ZE92-2106	ZE92-2107
DRZ400SM	04-16	ZE92-2106	ZE92-2107

CONTROL

BARCLAMP

LEVER

FOOT PARTS

HAND GUARD

BODY GUARD

BODY

ACCESSORIES

CARBON

Wheel Spacer Racer	Year	Color	Front	Rear
H	CR125R/250R	02-03	-	ZE93-3151
		04-07	ZE93-3071 #1	ZE93-3151
	CRF250R	04-08	ZE93-3071 #1	ZE93-3151
		09-12	ZE93-3071 #2	ZE93-3151
		13-17	ZE93-3071 #1	ZE93-3151
	CRF450R	02-03	-	ZE93-3151
		04-08	ZE93-3071 #1	ZE93-3151
		09-12	ZE93-3071 #2	ZE93-3151
		13-17	ZE93-3071 #1	ZE93-3151
	CRF450RX	17	ZE93-3071 #1	ZE93-3151
CRF250X/450X	04-17	ZE93-3051	ZE93-3151	
Y	YZ85	02-17	ZE93-3652	-
	YZ125/250	02-07	ZE93-3642	ZE93-3712 #1
		08-17	ZE93-3612	ZE93-3712 #1
	YZ250F	02	ZE93-3642	-
		03-06	ZE93-3642	ZE93-3712 #1
		07-08	ZE93-3612	ZE93-3712 #1
		09-13	ZE93-3612	ZE93-3752 #1
		14-17	ZE93-3672	ZE93-3752 #1
	YZ450F	03-07	ZE93-3642	ZE93-3712 #1
		08	ZE93-3612	ZE93-3712 #1
		09-13	ZE93-3612	ZE93-3752 #1
		14-17	ZE93-3672	ZE93-3752 #1
	YZ125X	17	ZE93-3672	ZE93-3752 #1
	YZ250X	16-17	ZE93-3612	ZE93-3712 #1
	YZ250FX	15-17	ZE93-3672	ZE93-3712 #1
YZ450FX	16-17	ZE93-3672	ZE93-3712 #1	
WR250F	03	-	ZE93-3712 #1	
WR450F	06-16	-	ZE93-3712 #1	
WR450F	06-16	-	ZE93-3712 #1	
YZ85	02-17	ZE93-3651	-	
YZ125/250	02-07	ZE93-3641	-	
	02	ZE93-3641	-	
YZ250F	03-06	ZE93-3641	-	
	09-13	-	ZE93-3751 #1	
	14-17	-	ZE93-3751 #1	
	03-07	ZE93-3641	-	
	09-13	-	ZE93-3751 #1	
YZ450F	14-17	-	ZE93-3751 #1	
	WR250F/450F	06-16	ZE93-3661	-
K	KX85/100	01-16	ZE93-3261 #1	-
	KX125/250	03-05	-	ZE93-3311
		06-08	ZE93-3211	ZE93-3311
	KX250F	04-05	-	ZE93-3311
	KX450F	06-17	ZE93-3211	ZE93-3311
KLX450R	08-15	-	ZE93-3311	
S	RMZ250	04-06	-	ZE93-3311
	RMZ450	07-12	ZE93-3411	ZE93-3511
		13-17	ZE93-3411	ZE93-3511 #1
	RMX450Z	05-12	ZE93-3411	ZE93-3511 #1
KTM	125-530 SX/SX-F/XC-F	03-12	ZE93-3814	ZE93-3864
	125-450 SX/SX-F/XC-F	13-14	ZE93-3814	ZE93-3884
	125-450SX/SX-F	15-17	ZE93-3824	ZE93-3884
	125-530EXC/EXC-F/EXC-W/XC-W/SMR	03-15	ZE93-3814	ZE93-3864
	125-500EXC/EXC-F/EXC-W/XC-W	16-17	ZE93-3824	ZE93-3864

#1 Model can not be used with stock dust cover
 #2 Model can not be used with stock disk cover

Wheel Spacer Racer	Year	Color	Front	Rear
H	CRF250L/M	12-16	ZE93-3081	ZE93-3161
	XR50M/100M	05-08	ZE93-3041	ZE93-3131
Y	TRICKER	04-16	-	ZE93-3732 #1
	XT250X	06-16	-	ZE93-3732 #1
	SEROW250	05-16	-	ZE93-3732 #1
K	KLX250/D-TRACKER	98-07	-	ZE93-3321 #1
	KLX300R	08-16	ZE93-3231	ZE93-3321 #1
S	250SB	96-	-	ZE93-3321 #1
	250SB	02-05	-	ZE93-3321 #1

#1 Model can not be used with stock dust cover

Fast Rear Wheel Spacer	Year	Color	Part #
H	CR125R/250R	05-07	ZE93-2102
	CRF250R	05-17	ZE93-2102
	CRF450R	05-16	ZE93-2102
	CRF250X	06-17	ZE93-2102
	CRF450X	05-16	ZE93-2102
Y	YZ125/250	99-17	ZE93-2416
	YZ250F/450F	06-08	ZE93-2416
		09-17	ZE93-2406
	YZ125X	17	ZE93-2416
	YZ250X	16-17	ZE93-2416
	YZ250FX	15-17	ZE93-2416
	YZ450FX	16-17	ZE93-2416
WR250F/450F	05-16	ZE93-2416	
K	KX125/250	03-08	ZE93-2202
	KX250F	04-17	ZE93-2202
	KX450F	06-17	ZE93-2202
S	RMZ250	04-17	ZE93-2302
	RMZ450	08-17	ZE93-2302
KTM	125-250SX/XC	13-17	ZE93-2503
	250-450SX/SX-F/XC-F	13-17	ZE93-2503
	125-530SX/SX-F/XC/XC-F	08-12	ZE93-2513
	125-530EXC/EXC-F/EXC-W/XCF-W	08-16	ZE93-2513



ZETA WHEEL SPACER

- Anodized wheel spacers, available in blue, red and orange.
- Ribs keeps spacer on the wheels for easy maintenance. (Excluding some models)
- Made of A7009 aluminum with hard anodized finish.
- Lighter and more durable than stock spacers.
- Spacers available for MX racers, Mini-Moto and trail models.
- Front and rear spacers sold separately.
- Left and right side spacers sold in pairs. (Excluding some models)



ZETA FAST REAR WHEEL SPACER

- Unique tapered design rear wheel spacers.
- Wheel spacers do not come off the hub during wheel installation, because of its tapered design.
- Protects wheel dust seals and bearings from mud and dirt.
- Made of aircraft grade aluminum and anodized finish.
- ZETA laser etching logo on side body, comes in pairs.



CONTROL

BARCLAMP

LEVER

FOOT PARTS

HAND GUARD

BODY GUARD

BODY

ACCESSORIES

CARBON



ZETA MAGNETIC DRAIN BOLT

- Magnetic drain bolts designed to pick up excess bits of metal in your engine oil.
- Made of A7009-T6 aluminum. Light weight design.
- Press fit magnet on the drain plugs.
- Includes safety wire holes to prevent mispased part.
- Available in blue, red and orange anodized colors.

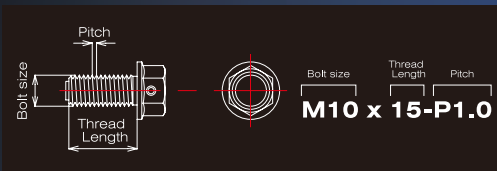

HONDA : ZE51-2032

YAMAHA : ZE51-2346

HUSQVARNA : ZE51-2546

KTM : ZE51-2443

ZETA BILLET KIT

- Aluminum billet kit for MX bikes.
- Buying one kit gives your bike factory look.
- Available in red, blue and orange anodized parts kits.

Contents of kit

HONDA, YAMAHA KAWASAKI, SUZUKI	YZ125/250/125X/250X	KTM, HUSQVARNA
F/R Brak reservoir cover	F/R Brak reservoir cover	F/R Brak reservoir cover
Brake line clamp	Brake line clamp	F Clutch reservoir cover
Oil filler plugs	Oil filler plugs	Oil filler plugs
Engine plugs	Axle block	Axle block
Axle block	Air valve caps	Air valve caps
Air valve caps	Rim lock nuts	Rim lock nuts
Rim lock nuts	Rim lock spacers	Rim lock spacers
Rim lock spacers		

DRZ400SM

- F/R Brak reservoir cover
- Brake line clamp
- Engine plugs
- Axle block
- Air valve caps

Magnetic Drain Bolt	Year	Size	Blue	Red	
HONDA	XR50R/CRF50F	99-17	M12X15-P1.5	ZE58-1522	ZE58-1523
	CR85R/RII	03-07	M12X15-P1.5	ZE58-1522	ZE58-1523
	CR125R/250R	02-07	M12X15-P1.5	ZE58-1522	ZE58-1523
	CRM250R	89-96	M12X15-P1.5	ZE58-1522	ZE58-1523
	CRM250AR	97-00	M12X15-P1.5	ZE58-1522	ZE58-1523
	CRF250L/M	12-16	M12X15-P1.5	ZE58-1522	ZE58-1523
	CRF1000L	16	M12X15-P1.5	ZE58-1522	ZE58-1523
	XR250/BAJA	95-07	M12X15-P1.5	ZE58-1522	ZE58-1523
	XR250MOTARD	03-07	M12X15-P1.5	ZE58-1522	ZE58-1523
	XR400MOTARD	05-08	M12X15-P1.5	ZE58-1522	ZE58-1523
YAMAHA	YZ125	05-17	M10X15-P1.25	ZE58-1222	ZE58-1223
	YZ250	97-17	M12X15-P1.5	ZE58-1522	ZE58-1523
	YZ250F	01-17	M10X15-P1.25	ZE58-1222	ZE58-1223
	YZ450F	03-09	M10X15-P1.25	ZE58-1222	ZE58-1223
		14-17	M10X15-P1.25	ZE58-1222	ZE58-1223
	YZ125X	17	M10X15-P1.25	ZE58-1222	ZE58-1223
	YZ250X	16-17	M12X15-P1.5	ZE58-1522	ZE58-1523
	YZ250FX	15-17	M10X15-P1.25	ZE58-1222	ZE58-1223
	YZ450FX	16-17	M10X15-P1.25	ZE58-1222	ZE58-1223
	WR250F	01-16	M10X15-P1.25	ZE58-1222	ZE58-1223
KAWASAKI	WR450F	04-11	M10X15-P1.25	ZE58-1222	ZE58-1223
		16	M10X15-P1.25	ZE58-1222	ZE58-1223
	TRICKER	04-16	M12X15-P1.5	ZE58-1522	ZE58-1523
	SEROW250	05-16	M12X15-P1.5	ZE58-1522	ZE58-1523
	XT250X	06-16	M12X15-P1.5	ZE58-1522	ZE58-1523
	WR250R/X	07-17	M12X15-P1.5	ZE58-1522	ZE58-1523
	KX65	00-17	M10X15-P1.5	ZE58-1322	ZE58-1323
	KX85/100	01-17	M10X15-P1.5	ZE58-1322	ZE58-1323
	KX125/250	96-08	M10X15-P1.5	ZE58-1322	ZE58-1323
	KX250F	04-17	M10X15-P1.5	ZE58-1322	ZE58-1323
SUZUKI	KX450F	06-15	M10X22-P1.5	ZE58-1342	ZE58-1343
		16-17	M10X15-P1.5	ZE58-1322	ZE58-1323
	KLX110/L	02-17	M12X15-P1.5	ZE58-1522	ZE58-1523
	KLX450R	08-09	M10X22-P1.5	ZE58-1342	ZE58-1343
	KLX125,D-TRACKER125	10-16	M12X15-P1.5	ZE58-1522	ZE58-1523
	KLX150S	09-13	M12X15-P1.5	ZE58-1522	ZE58-1523
	KLX250/D-TRACKER	98-16	M10X15-P1.5	ZE58-1322	ZE58-1323
	RMZ250	07-17	M12X10-P1.25	ZE58-1412	ZE58-1413
	250SB	02-06	M10X15-P1.5	ZE58-1322	ZE58-1323
	DRZ400S/E/SM(CRANKCASE)	00-16	M12X10-P1.25	ZE58-1412	ZE58-1413
HUSKY	DRZ400S/E/SM(FRAME)	00-16	M10X15-P1.25	ZE58-1222	ZE58-1223
	TC125/250	14-17			
	TE125-300	14-17	M12X12-P1.5*	ZE58-1512	-
	FC250-450	14-17			
	FE250-501	14-17			
KTM	TX/FX125-450	17			

Verify stock bolt size before purchas

Billet Kit	Year	Red	Blue
HONDA	CRF250R	10-17	ZE51-2032
	CRF450R	02-16	ZE51-2032
	CRF250L/M	12-16	ZE51-2072
YAMAHA	YZ125/250	09-17	ZE51-2326
	YZ250F/450F	14-17	-
	YZ125X	17	ZE51-2326
	YZ250X	16-17	ZE51-2326
	YZ250FX	15-17	ZE51-2366
	YZ450FX	16-17	ZE51-2366
	WR250F	15-16	ZE51-2366
	WR450F	16	ZE51-2366
	WR250R/X	07-17	ZE51-2366
	KAWASAKI	KX250F	11-16
		17	ZE51-2142
KX450F		09-15	ZE51-2132
		16-17	ZE51-2142
SUZUKI	RMZ250	07-17	ZE51-2232
	RMZ450	05-17	ZE51-2232
	DRZ400SM	05-15	ZE51-2272
	FC250(US)	14	ZE51-2546
HUSQVARNA	FC250	14-15	ZE51-2546
	FC350	16-17	ZE51-2556
	FC450(US)	14-15	ZE51-2546
	FC450	16-17	ZE51-2556
	TC85	15-17	ZE51-2526
	TC125	16-17	ZE51-2556
	TC250	17	ZE51-2556
	FE250-501	14-16	ZE51-2546
	TE125	17	ZE51-2566
	TE250/300	14-16	ZE51-2566
	TE150-300	17	ZE51-2566
	TX125	17	ZE51-2566
	TX300	17	ZE51-2566
	FX350/450	17	ZE51-2556

Billet Kit	Year	Orange
85SX	15-17	ZE51-2423
125SX	16-17	ZE51-2443
125XC-W	17	ZE51-2433
150SX	16-17	ZE51-2443
150XC-W	17	ZE51-2433
250SX/XC	06-12	ZE51-2433
250SX	13-17	ZE51-2443
250XC	13-17	ZE51-2443
250SX-F/XC-F	07-12	ZE51-2433
250XC-F/XC-F	13-17	ZE51-2443
250XC-W	06-17	ZE51-2433
250XC-F-W	07-16	ZE51-2433
250EXC/XC-F (SIX DAYS)	06-17	ZE51-2433
300XC	13-17	ZE51-2443
300XC	06-17	ZE51-2433
300XC-W	06-17	ZE51-2433
350SX-F/XC-F	11-12	ZE51-2433
350SX-F/XC-F	13-17	ZE51-2443
350EXC-F/XC-F-W	12-17	ZE51-2433
400XC-W/EXC/XC-R	09-11	ZE51-2433
450SX-F/XC-F	13-17	ZE51-2443
450EXC/XC-F	07-17	ZE51-2433
450XC-W	08-16	ZE51-2433
500XC-W/EXC/XC-F (SIX DAYS)	12-17	ZE51-2433
530XC-W/XCR-W/EXC-R/EXC	08-11	ZE51-2433
FREERIDE 250R	14-17	ZE51-2423
FREERIDE 350	13-17	ZE51-2423

Bike	Year	Size	Black	Blue	Red
HONDA					
XR50R /CRF50F	99-17	M22 x 30-P1.0 H12	-	ZE58-2032	ZE58-2033
CR85R/RII	03-07	M24 x 30-P1.0 H12	ZE58-2121	-	ZE58-2123
CRF150R/RII	07-17	M24 x 30-P1.0 H12	ZE58-2121	-	ZE58-2123
CR125R/250R	01-07	M26 x 32-P1.0 H10	-	-	ZE58-2323
CRF250R/X	04-17	M26 x 32-P1.0 H10	-	-	ZE58-2323
CRF450R	02-17	M26 x 32-P1.0 H10	-	-	ZE58-2323
CRF450RX	17	M26 x 32-P1.0 H10	-	-	ZE58-2323
CRF450X	05-17	M26 x 32-P1.0 H10	-	-	ZE58-2323
CRM50/80	88-99	M24 x 30-P1.0 H12	ZE58-2121	-	ZE58-2123
CRM250R	89-96	M24 x 30-P1.0 H12	ZE58-2121	-	ZE58-2123
CRM250AR	97-00	M24 x 30-P1.0 H12	ZE58-2121	-	ZE58-2123
CRF250L/M	12-16	M24 x 30-P1.0 H12	ZE58-2121	-	ZE58-2123
CRF1000L	16	M24 x 30-P1.0 H12	ZE58-2121	-	ZE58-2123
XR230/Motard	05-12	M24 x 30-P1.0 H12	ZE58-2121	-	ZE58-2123
XR250/BAJA	95-07	M24 x 30-P1.0 H12	ZE58-2121	-	ZE58-2123
XR250/Motard	03-07	M24 x 30-P1.0 H12	ZE58-2121	-	ZE58-2123
XR400/Motard	05-08	M24 x 30-P1.0 H12	ZE58-2121	-	ZE58-2123
YAMAHA					
YZ85/LW	02-17	M22 x 27-P1.0 H12	-	ZE58-2022	ZE58-2023
YZ125/250	94-17	M24 x 32-P1.0 H12	-	ZE58-2222	ZE58-2223
YZ250F	01-17	M24 x 32-P1.0 H12	-	ZE58-2222	ZE58-2223
YZ450F	03-17	M24 x 32-P1.0 H12	-	ZE58-2222	ZE58-2223
YZ400/426F	98-02	M24 x 32-P1.0 H12	-	ZE58-2222	ZE58-2223
YZ125X	17	M24 x 32-P1.0 H12	-	ZE58-2222	ZE58-2223
YZ250X	16-17	M24 x 32-P1.0 H12	-	ZE58-2222	ZE58-2223
YZ250FX	15-17	M24 x 32-P1.0 H12	-	ZE58-2222	ZE58-2223
YZ450FX	16-17	M24 x 32-P1.0 H12	-	ZE58-2222	ZE58-2223
WR250F	01-16	M24 x 32-P1.0 H12	-	ZE58-2222	ZE58-2223
WR450F	04-16	M24 x 32-P1.0 H12	-	ZE58-2222	ZE58-2223
TTR50E	07-16	M22 x 27-P1.0 H12	-	ZE58-2022	ZE58-2023
TTR110E	08	M22 x 27-P1.0 H12	-	ZE58-2022	ZE58-2023
TTR125	02-16	M22 x 27-P1.0 H12	-	ZE58-2022	ZE58-2023
TT250R	93-97	M24 x 30-P1.5 H14	ZE58-2151	ZE58-2152	ZE58-2153
TRICKER	04-16	M22 X 27-P1.0 H12	-	ZE58-2022	ZE58-2023
SEROW250	05-16	M22 X 27-P1.0 H12	-	ZE58-2022	ZE58-2023
XT250X	06-16	M22 X 27-P1.0 H12	-	ZE58-2022	ZE58-2023
WR250R/X	07-17	M24 X 30-P1.5 H14	ZE58-2151	ZE58-2152	ZE58-2153
KAWASAKI					
KX65	00-17	M22 x 30-P1.0 H12	-	ZE58-2032	ZE58-2033
KX85/100	01-17	M22 x 30-P1.0 H12	-	ZE58-2032	ZE58-2033
KX125/250	88-91	M22 x 30-P1.0 H12	-	ZE58-2032	ZE58-2033
	04-08	M24 x 32-P1.5 H10	ZE58-2251	ZE58-2252	ZE58-2253
KX250F	04-17	M24 x 32-P1.5 H10	ZE58-2251	ZE58-2252	ZE58-2253
KX450F	06-17	M24 x 32-P1.5 H10	ZE58-2251	ZE58-2252	ZE58-2253
KLX110/L	02-17	M22 x 30-P1.0 H12	-	ZE58-2032	ZE58-2033
KLX125 D-Tracker125	10-16	M22 x 30-P1.0 H12	-	ZE58-2032	ZE58-2033
KLX150S	09-	M22 x 30-P1.0 H12	-	ZE58-2032	ZE58-2033
KLX250 /D-Tracker	98-16	M22 x 30-P1.0 H12	-	ZE58-2032	ZE58-2033
KLX450R	08-09	M24 x 32-P1.5 H10	ZE58-2251	ZE58-2252	ZE58-2253
SUZUKI					
RM85/L	02-16	M22 x 30-P1.0 H12	-	ZE58-2032	ZE58-2033
RM125/250	04-13	M24 x 32-P1.0 H12	-	ZE58-2222	ZE58-2223
RMZ250	04-06	M24 x 32-P1.5 H10	ZE58-2251	ZE58-2252	ZE58-2253
	07-17	M24 x 32-P1.0 H12	-	ZE58-2222	ZE58-2223
RMZ450	05-17	M24 x 32-P1.0 H12	-	ZE58-2222	ZE58-2223
RMX450Z	10-16	M24 x 32-P1.0 H12	-	ZE58-2222	ZE58-2223
RMX250/S	92-98	M24 x 32-P1.5 H10	ZE58-2251	ZE58-2252	ZE58-2253
DJEBEL250XC	95-06	M24 x 32-P1.5 H10	ZE58-2251	ZE58-2252	ZE58-2253
250SB	02-06	M22 x 30-P1.0 H12	-	ZE58-2032	ZE58-2033
DRZ400S/E	00-16	M24 x 32-P1.5 H10	ZE58-2251	ZE58-2252	ZE58-2253
DRZ400SM	05-16	M24 x 32-P1.5 H10	ZE58-2251	ZE58-2252	ZE58-2253



ZETA STEERING STEM NUT & BOLT

- CNC Machined steering stem nut and bolt.
- Made of A7009-T6 aluminum, light weight design.
- Available in red, blue, black and orange anodized colors.
- Bolt type for KTM in and Husqvarna.

Steering stem nut



Steering stem bolt

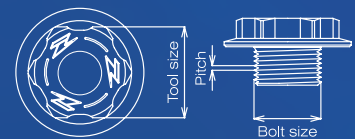

Nut/Bolt size Tool size Pitch Height

M26 x 32-P1.0 H10

Bike	Year	Size	Blue	Red	Orange
KTM					
125-530SX/SX-F/EXC/EXC-F/EXC-R/XC/XC-W/XC-F	-	M20 x 27-P1.5 L=11.5*	-	-	ZE58-2817
450-690 SMR/SMC/Enduro/R/Adventure/Supermoto/R/Duke	-				
ATV SX/XC	-				
FREERIDE250R	14-17				
FREERIDE350	12-17				
HUSQVARNA					
WR125	08-13	M26 x 32-P1.0 H10	-	ZE58-2323	-
TC125	14-17	M20 x 27-P1.5 L=11.5*	ZE58-2812	-	-
TC250	09-13	M26 x 32-P1.0 H10	-	ZE58-2323	-
	14-17	M20 x 27-P1.5 L=11.5*	ZE58-2812	-	-
TE125	14-16	M20 x 27-P1.5 L=11.5*	ZE58-2812	-	-
TE250	09-13	M26 x 32-P1.0 H10	-	ZE58-2323	-
	14-17	M20 x 27-P1.5 L=11.5*	ZE58-2812	-	-
TE300	14-17	M20 x 27-P1.5 L=11.5*	ZE58-2812	-	-
FC250-450	14-17	M20 x 27-P1.5 L=11.5*	ZE58-2812	-	-
FE250-501	14-17	M20 x 27-P1.5 L=11.5*	ZE58-2812	-	-
TX/FX125-450	17	M20 x 27-P1.5 L=11.5*	ZE58-2812	-	-
SM250R	09	M26 x 32-P1.0 H10	-	ZE58-2323	-

*Verify stock bolt size before purchas

ZETA STEM CAP

- Aluminum stem shaft cap keeps dirt and mud out to prevent rust inside of the stem shaft.
- Made of A7009-T6 aluminum and light weight design.
- Available in titanium, black, blue and red anodized colors with cool laser print Zeta logo.
- Leaf springs hold inside of stem shaft and won't come off even in hard riding.
- Fits shaft inner diameter from 13 mm to 17.5 mm, fits almost all of dirt, super moto and dual sport bikes.

Part number	Color	Part number	Color
ZE58-4130	Titanium	ZE58-4132	Blue
ZE58-4131	Black	ZE58-4133	Red

CONTROL

BARCLAMP

LEVER

FOOT PARTS

HAND GUARD

BODY GUARD

BODY

ACCESSORIES

CARBON



ZETA
REAR AXLE BLOCKS

- CNC machined anodized axle blocks.
- Rotate using the forward and reverse positions, able to offset axle shaft 13 mm in reverse position. (Mini size is 11 mm)
- Scales on both sides of axle block for easy adjusting.

KX250F/450F
ZE93-5120

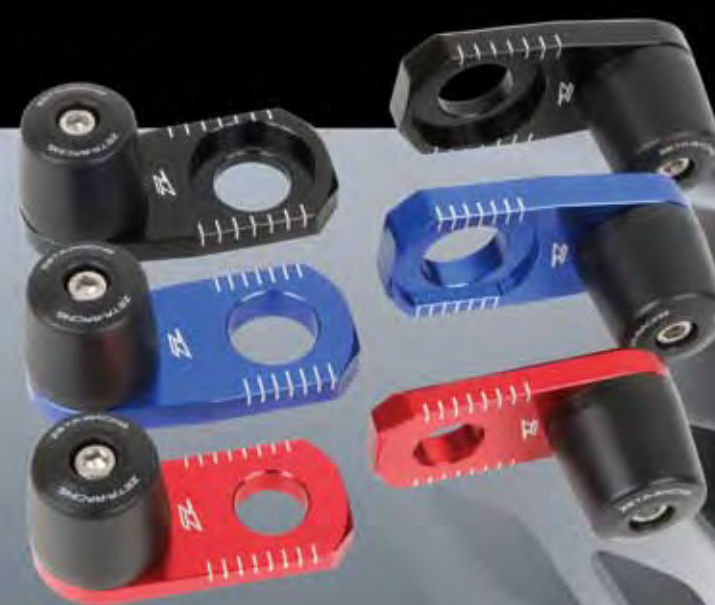

ZETA
REAR AXLE SLIDER

- Protects rear axle shaft and nut from damage when falling down.
- Made of A7009 aluminum with color anodized finish, covered by POM material.

Bike	Year	Part #			
		Black	Red	Blue	
HONDA	CRF250L/M	12-16	ZE93-6150	ZE93-6152	-
YAMAHA	WR250R/X	07-17	ZE93-6750	-	ZE93-6753
KAWASAKI	KLX250/D-Tracker	08-16	ZE93-6350	-	-
SUZUKI	DRZ400SM	05-16	ZE93-6550	-	-



Replacement Slider
Part number [ZE93-6990](#)

Bike	Year	Red	Blue	Ti-color
HONDA	CR125R/CR250R	02-07	ZE93-5013	-
	CRF250R/X	04-17	ZE93-5013	-
	CRF450R	02-17	ZE93-5013	-
	CRF450RX	17	ZE93-5013	-
	CRF450X	05-17	ZE93-5013	-
	CRF250L/M	12-16	ZE93-5063	-
YAMAHA	YZ125/250	02-17	ZE93-5313	ZE93-5312
		02-08	ZE93-5313	ZE93-5312
	YZ250F	09-11	ZE93-5333	ZE93-5332
		12-17	ZE93-5343	ZE93-5342
		03-08	ZE93-5313	ZE93-5312
	YZ450F	09	ZE93-5333	ZE93-5332
		10-17	ZE93-5343	ZE93-5342
	YZ125X	17	ZE93-5313	ZE93-5312
	YZ250X	16-17	ZE93-5313	ZE93-5312
	YZ250FX	15-17	ZE93-5313	ZE93-5312
KAWASAKI	YZ450FX	16-17	ZE93-5313	ZE93-5312
	WR250F	02-16	ZE93-5313	ZE93-5312
	WR450F	04-16	ZE93-5313	ZE93-5312
	WR250R/X	07-17	ZE93-5313	ZE93-5312
	KX85/100	01-17	ZE93-5133	ZE93-5132
	KX125/250	03-08	ZE93-5113	ZE93-5112
	KX250F	04-16	ZE93-5113	ZE93-5112
		17	ZE93-5143	ZE93-5142
	KX450F	06-15	ZE93-5113	ZE93-5112
		16-17	ZE93-5143	ZE93-5142
SUZUKI	KLX450R	08-15	ZE93-5113	ZE93-5112
	KLX250/D-TRACKER	08-16	-	ZE93-5152
	RM85	04-16	-	ZE93-5232
	RMZ250	04-17	ZE93-5113	ZE93-5112
HUSKY	TC85	14-15	ZE93-5113	ZE93-5112
	TC125	16-17	ZE93-5113	ZE93-5112
	TC250	14-16	ZE93-5113	ZE93-5112
		17	ZE93-5143	ZE93-5142
	TE125-300	14-17	ZE93-5113	ZE93-5112
	TX125	17	ZE93-5113	ZE93-5112
	TX300	17	ZE93-5113	ZE93-5112
	FC350	14-15	ZE93-5113	ZE93-5112
		16-17	ZE93-5143	ZE93-5142
	FC250/450	14-15	ZE93-5113	ZE93-5112
	16-17	ZE93-5143	ZE93-5142	
	FE250-501	14-17	ZE93-5113	ZE93-5112
	FX350-450	17	ZE93-5143	ZE93-5142

Bike	Year	Orange
65SX	98-15	ZE93-5437
	16-17	ZE93-5457
	03-14	ZE93-5427
85SX	15-17	ZE93-5447
	-12	ZE93-5427
125-450SX/SX-F/XC/XC-F	00-17	ZE93-5427
	13-17	ZE93-5417
	14-17	ZE93-5447
	12-17	ZE93-5447
125-530EXC/EXC-F/XC-W/XCF-W		
125-450SX/SX-F/XC/XC-F		
FREERIDE 250R		
FREERIDE 350		





ZETA RACING FLOOR MAT



- Motorcycle floor mat made of high absorption polyester and PVC oil resistance rubber mat.
- 1.5mm PVC rubber is oil and gasoline resistance, will not infiltrate oil or gasoline to ground.
- Dimple back side rubber design prevents slippage, great to use for motorcycle display at shop or garage.
- Polyester carpet surface can be washed with high pressure water.
- Mat required for events under FIM regulations.

Part number
DK-2400A-Z1

Size
86 x 211 cm (33.8" x 83")



ZETA DIECUT STICKERS

Size 400 x 45 mm

Part number Color
ZE50-3134 White
ZE50-3634 Black

Size 600 x 67mm

Part number Color
ZE50-3136 White
ZE50-3636 Black



ZETA Racing Black



ZETA Racing White

ZETA FRONT FENDER DECAL

Part number Color
MO33-0701 ZETA Racing Black
MO33-0702 ZETA Racing White



ZE50-2111



ZE50-2113



ZE50-2115

ZETA STICKERS

Part number Size
ZE50-2111 65 x 35 mm
ZE50-2113 100 x 20 mm
ZE50-2115 150 x 30 mm



ZETA STICKER KIT 2pcs

Part number Size
ZE50-0103 47 x 20 mm
(1.85" x 0.7")



ZETA TRACK TAPE



- Track tape for MX and Ed track use.
- Available DF Yellow, ZETA Blue.

Size W 75 mm x L 200m per roll
Part number Description
DF29-7021 DIRTBREAK
DF29-7041 ZETA



ZETA DISPLAY RACK

Part number D39-11-111
Size 70 X 190 cm
(2.3" x 6.2")



ZETA LOGO BANNER

Part number Size
ZE65-0501 30 x 90 cm (1" x 3")

CONTROL

BARCLAMP

LEVER

FOOT PARTS

HAND GUARD

BODY GUARD

BODY

ACCESSORIES

CARBON



Z-CARBON
FRONT DISC GUARD

- Light weight carbon fiber brake disc guard.
- Protect your front brake disc from rocks, brush and debris during your ride.
- Prevents mud and dirt from getting on the disc, so your brakes function properly in a muddy race.
- Slim and light weight design will not affect the handling of the bike.
- Disc guard and bracket sold separately to allow larger range of combinations.
- # Model specific mounting kit required for installation.
- # Modification may be needed for some models.

Part number	Description
ZC35-1201	Up to 240 mm brake disc
ZC35-1202	Up to 270 mm brake disc



Z-CARBON
AIR SCOOP

- Carbon fiber front brake caliper air scoop for super moto bikes.
- Efficiently directs cool air to brake caliper to keep it cool and prevent brake fade.
- Can be used on up to 320 mm brake disc.
- # Model specific mounting kit required for installation.
- # Modification may be needed for some models.

Part number
[ZC35-1203](#)

ZETA
FRONT DISC GUARD MOUNTING KIT

- Model specific mounting kit. (Required for installation)
- Mount bracket is integrated with wheel spacer.



Bike	Year	Mounting kit	Air scoop/ Disc guard
HONDA			
CRF150R	07-16	ZE52-1100	ZC35-1201
CR125R/250R	04-07	ZE52-1120	ZC35-1202
CRF250R	04-17	ZE52-1120	ZC35-1202
CRF450R	04-16	ZE52-1120	ZC35-1202
CRF250X/450X	04-17	ZE52-1120	ZC35-1202
CRF250L/M	12-16	ZE52-1180	ZC35-1202
YAMAHA			
YZ125/250	08-17	ZE52-1420	ZC35-1202
YZ250F	07-13	ZE52-1420	ZC35-1202
	14-17	ZE52-1430	ZC35-1202
YZ450F	07-13	ZE52-1420	ZC35-1202
	14-17	ZE52-1430	ZC35-1202
YZ125X	17	ZE52-1420	ZC35-1202
YZ250X	16-17	ZE52-1420	ZC35-1202
YZ250FX	15-17	ZE52-1430	ZC35-1202
YZ450FX	16-17	ZE52-1430	ZC35-1202
WR250F	06-16	ZE52-1420	ZC35-1202
WR450F	06-16	ZE52-1420	ZC35-1202
WR250R	07-17	ZE52-1470	ZC35-1202
WR250X	07-17	ZE52-1470	ZC35-1203
KAWASAKI			
KX125/250	06-08	ZE52-1220	ZC35-1202
KX250F	06-17	ZE52-1220	ZC35-1202
KX450F	06-17	ZE52-1220	ZC35-1202
KLX450R	08-15	ZE52-1220	ZC35-1202
KLX125	10-16	ZE52-1280	ZC35-1201
KLX150S	09-13	ZE52-1280	ZC35-1201
KLX250	08-16	ZE52-1270	ZC35-1202
D-TRACKER/X	08-16	ZE52-1270	ZC35-1203

Bike	Year	Mounting kit	Air scoop/ Disc guard
SUZUKI			
RM85	02-16	ZE52-1300	ZC35-1201
RMZ250	07-17	ZE52-1320	ZC35-1202
RMZ450	05-17	ZE52-1320	ZC35-1202
RMX450Z	10-16	ZE52-1320	ZC35-1202
DRZ400SM	04-16	ZE52-1380	ZC35-1203
KTM			
85/105 SX/XC	03-11	ZE52-1500	ZC35-1201
125-530SX/SX-F	03-14	ZE52-1520	ZC35-1202
/XC/XC-F	15-17	ZE52-1530	ZC35-1202
125-530EXC	03-15	ZE52-1520	ZC35-1202
/EXC-F	16-17	ZE52-1530	ZC35-1202
450-525SMR	04-10	ZE52-1520	ZC35-1203
HUSQVARNA			
CRWR 125-300	09-11	ZE52-1610	ZC35-1202
TC/TE 250-511	09-11	ZE52-1610	ZC35-1202
SM 450-510	09	ZE52-1610	ZC35-1203
TC/FC 125-450	14	ZE52-1520	ZC35-1202
	15-17	ZE52-1530	ZC35-1202
TE/FE 125-501	14-15	ZE52-1520	ZC35-1202
	16-17	ZE52-1530	ZC35-1202
TX/FX125-450	17	ZE52-1530	ZC35-1202

Bike	Year	Part#
HONDA		
CRF150R	07-17	ZC31-3130
	10-13	ZC31-3180
CRF250R	14-17	ZC31-3150
	05-08	ZC31-3170
CRF450R	09-14	ZC31-3150
XR250/BAJA/MOTARD	95-07	ZC31-3120
XR230/MOTARD	08-12	ZC31-3170
YAMAHA		
YZ250F	10-12	ZC31-3440
YZ450F	08-09	ZC31-3450
WR250R/X	07-17	ZC31-3410
KAWASAKI		
KX250F	04-09	ZC31-3150
	10-12	ZC31-3241
KX450F	09	ZC31-3250
KLX125,D-TRACKER125	10-16	ZC31-3230
KLX150S	09-13	ZC31-3230
KLX250, D-TRACKER	01-16	ZC31-3210
SUZUKI		
RMZ250	04-06	ZC31-3150
	07-17	ZC31-3330
	05-07	ZC31-3330
RMZ450	08-09	ZC31-3350
250SB	02-06	ZC31-3210
DRZ400S/R/SM	00-16	ZC31-3310



Z-CARBON
EX PIPE GUARD

- Carbon head pipe guards.
- Guards for specific models and universal type are available.
- Universal type exhaust pipe fitting diameter is from 26 mm to 50 mm.



Universal type
ZC31-3000



Replacement Mount kit
ZC31-3901

CONTROL

BARCLAMP

LEVER

FOOT PARTS

HAND GUARD

BODY GUARD

BODY

ACCESSORIES

CARBON



Z-CARBON
MX HANDGUARD ZC

- Super light weight carbon fiber MX hand guards.
- Protect your hands from brush and water during your ride.
- Handlebar clamp style hand guards fit almost all dirt bikes and ATVs.
- Comes complete with installation hardware.
- Replacement mount kit available.

Part number
ZC41-2311



Replacement mount kit
ZE74-0910



Z-CARBON
ARMOR HANDGUARD ZC

- Light weight carbon fiber deflector shields for ZETA Armor hand guards (sold separately).
- Protect your hands from brush and water during your ride.
- Includes mounting screws to attach armor hand guards.

Part number
ZC41-2310



ZETA Armor hand guards P26-27



Z-CARBON FRAME GUARD

- Carbon frame guards prevent scratches and chipping of your bike.
- Flat surface provides better grip and control.
- Designed specifically for each model.
- Made of aircraft grade dry carbon fiber for light weight and durable construction.

	Bike	Year	Part #
H	CRF150R	07-17	ZC35-5101
	CRF250L/M	12-16	ZC35-5106
	XR250/Baja/Motard	95-07	ZC35-5105
Y	WR250R/X	07-17	ZC35-5134
K	KLX125, D-Tracker125	10-16	ZC35-5112
	KLX150S	09-13	ZC35-5112
	KLX250, D-Tracker	93-16	ZC35-5115
S	DRZ400S/R/SM	00-16	ZC35-5125



CRF250L



KLX250



Z-CARBON DRIVE COVER

- Light weight durable carbon drive cover.
- Designed to keep mud out of the front sprocket area.

	Bike	Year	Part #
H	CRF250R	04-17	ZC35-3102
	CRF450R	08-16	ZC35-3102
	CRF250X	04-17	ZC35-3102
	XR250/Baja/Motard	95-07	ZC35-3105
Y	YZ250F	01-13	ZC35-3132
	YZ450F	06-13	ZC35-3132
	WR250F	01-14	ZC35-3132
	WR450F	07-15	ZC35-3132
	WR250R/X	07-17	ZC35-3135
K	KX250F	04-16	ZC35-3112
	KX450F	09-16	ZC35-3113
	KLX125, D-Tracker125	10-16	ZC35-3117
S	KLX150S	09-13	ZC35-3117
	KLX250, D-Tracker	93-16	ZC35-3115
S	RMZ250	04-06	ZC35-3112
	RMZ450	05-17	ZC35-3122
	250SB	02-06	ZC35-3115
	DRZ400S/R/SM	00-15	ZC35-3125



CRF250R/450R



WR250R/X

CONTROL

BARCLAMP

LEVER

FOOT PARTS

HAND GUARD

BODY GUARD

BODY

ACCESSORIES

CARBON



Z-CARBON CHAIN COVER

- Carbon chain cover for dual sport bikes.
- Install with OE chain cover bracket on swing arm.
- Light weight protection for your heels from the drive chain and sprocket.

	Bike	Year	Part #
H	XR250/Baja	95-07	ZC35-2206
Y	Serow250	05-16	ZC35-2206
	WR250R/X	07-17	ZC35-2206
K	KLX125, D-Tracker125	10-16	ZC35-2217
	KLX150S	09-13	ZC35-2217
S	KLX250, D-Tracker	93-16	ZC35-2215 #
	250SB	02-06	ZC35-2215
	DR250R	95-	ZC35-2215
	DRZ400S/SM	00-16	ZC35-2225

#Can not be used for the US models.



WR250R/X



KLX125



Z-CARBON CHAIN GUIDE

- Carbon chain guide.
- Lighter than stock aluminum chain guides.

	Bike	Year	Part #
H	CR125R/250R	05-07	ZC35-2102
	CRF150R	07-17	ZC35-2100
	CRF250R	05-17	ZC35-2102
	CRF450R	05-17	ZC35-2102
	CRF450RX	17	ZC35-2102
	CRF250X	06-17	ZC35-2102
	CRF450X	05-16	ZC35-2102
	CRF250L/M	12-16	ZC35-2105
	XR250/Baja/Motard	95-07	ZC35-2105
	YZ125/250	08-17	ZC35-2132
Y	YZ250F	07-17	ZC35-2132
	YZ450F	07-17	ZC35-2132
	YZ125X	17	ZC35-2132
	YZ250X	16-17	ZC35-2132
	WR250F/450F	07-15	ZC35-2132
K	WR250R/X	07-17	ZC35-2135
	KX250F/450F	09-17	ZC35-2112
	KLX140	08-14	ZC35-2117
	KLX150S	09-13	ZC35-2117
	KLX250, D-Tracker	93-16	ZC35-2115
	RM125/250	99-08	ZC35-2122
S	RMZ250	07-17	ZC35-2122
	RMZ450	05-17	ZC35-2122
	RMX450Z	10-15	ZC35-2122
	250SB	02-06	ZC35-2115
	DRZ400S/R/SM	00-15	ZC35-2122



RMZ250



WR250R/X

Z-CARBON REAR CALIPER GUARD

- Durable and beautiful light weight carbon rear brake caliper guards.
- Protect rear brake caliper from rocks.

	Bike	Year	Part #
H	CR85R	03-07	ZC35-0104
	CR125R/250R	02-07	ZC35-0102
	CRF150R	07-17	ZC35-0102
	CRF250R	04-17	ZC35-0102
	CRF450R	02-17	ZC35-0102
	CRF450RX	17	ZC35-0102
	CRF250X	04-17	ZC35-0102
	CRF450X	05-16	ZC35-0102
	XR250/Baja/Motard	95-07	ZC35-0104
	YZ125/250	06-17	ZC35-0133
Y	YZ250F/450F	06-17	ZC35-0133
	YZ125X	17	ZC35-0133
	YZ250X	16-17	ZC35-0133
	WR250F/450F	06-16	ZC35-0133
	WR250R/X	07-17	ZC35-0133
K	KX250F	04-17	ZC35-0112
	KX450F	06-17	ZC35-0112
	KLX250, D-Tracker	98-16	ZC35-0114
S	RM125/250	05-08	ZC35-0122
	RMZ250	04-06	ZC35-0112
S	RMZ250	07-17	ZC35-0122
	RMZ450	05-17	ZC35-0122
	RMX450Z	10-15	ZC35-0122
	250SB	02-06	ZC35-0114
	DRZ400SM	04-16	ZC35-0122



YZ250F



WR250R/X

Z-CARBON REAR DISC GUARD

- Light weight and durable carbon disc guard.
- Protect your rear disc from rocks and roots.

	Bike	Year	Part #
H	CR125R/250R	02-07	ZC35-1102
	CRF250R	04-17	ZC35-1102
	CRF450R	02-17	ZC35-1102
	CRF450RX	17	ZC35-1102
	CRF250X	04-17	ZC35-1102
	CRF450X	05-16	ZC35-1102
	XR250/Baja	95-07	ZC35-1105
	YZ125/250	06-17	ZC35-1132
	YZ250F	06-17	ZC35-1132
	YZ450F	06-17	ZC35-1132
Y	YZ125X	17	ZC35-1132
	YZ250X	16-17	ZC35-1132
	WR250F	06-16	ZC35-1132
	WR450F	06-16	ZC35-1132
	WR250R/X	07-17	ZC35-1132
K	KX250F	04-17	ZC35-1112
	KX450F	06-17	ZC35-1112
S	RM125/250	05-08	ZC35-1122
	RMZ250	04-06	ZC35-1112
S	RMZ250	07-17	ZC35-1122
	RMZ450	05-17	ZC35-1122
	RMX450Z	10-15	ZC35-1122
	DRZ400SM	00-16	ZC35-1122



YZ250F



DRZ400SM

Z-CARBON FORK WRAPS

- Carbon front fork wrap for dirt bikes.
- Made of aircraft grade durable dry carbon fiber.
- Protect your front fork outer tube from brush and water during your ride.
- Easy to install, just attach on to front forks.
- Lower and upper fork guards available, comes in a pair.

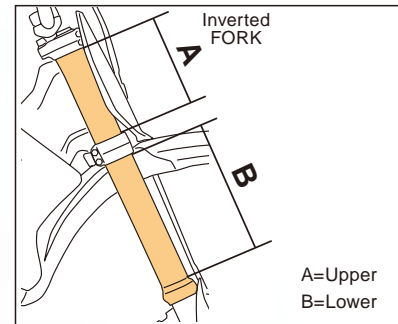

Please measure the length of A and B in the picture above and refer to list below for your fork wrap part number.

FORK WRAPS SIZE CHART

Description	Part #	Size (mm)	
		Length	Diameter
UPR	ZC35-4312	140	45
	ZC35-4314	164	45
	ZC35-4332	160	52
	ZC35-4334	178	52
Description	Part #	Size (mm)	
		Length	Diameter
LWR	ZC35-4316	220	45
	ZC35-4318	240	45
	ZC35-4336	225	52
	ZC35-4338	248	52

Bike	Year	UPR	LWR
HONDA			
CR85R	03-07	ZC35-4312	ZC35-4318
CRF150R	07-17	ZC35-4312	ZC35-4318
CRF250R/450R	02-17	ZC35-4334	ZC35-4338
CRF450RX	17	ZC35-4334	ZC35-4338
CRF250X/450X	04-17	ZC35-4334	ZC35-4338
XR250/MOTARD	03-07	ZC35-4332	ZC35-4336
CRF250L/M	12-16	ZC35-4332	ZC35-4336
YAMAHA			
YZ85	02-17	ZC35-4312	ZC35-4318
YZ125/250	08-17	ZC35-4334	ZC35-4338
YZ250F/450F	08-17	ZC35-4334	ZC35-4338
YZ125X	17	ZC35-4334	ZC35-4338
YZ250X	16-17	ZC35-4334	ZC35-4338
YZ250FX	15-17	ZC35-4334	ZC35-4338
YZ450FX	16-17	ZC35-4334	ZC35-4338
WR250F	07-16	ZC35-4334	ZC35-4338
WR450F	07-16	ZC35-4334	ZC35-4338
WR250R/X	07-17	ZC35-4332	ZC35-4336

Bike	Year	UPR	LWR
KAWASAKI			
KX85/100	01-17	ZC35-4312	ZC35-4316
KX250F	07-17	ZC35-4334	ZC35-4336
KX450F	07-17	ZC35-4334	ZC35-4338
KLX450R	08-15	ZC35-4334	ZC35-4338
KLX250/ D-TRACKER	98-16	ZC35-4332	ZC35-4336
SUZUKI			
RM85	02-16	ZC35-4314	ZC35-4318
RM-Z250	07-17	ZC35-4332	ZC35-4338
RM-Z450	08-17	ZC35-4332	ZC35-4338
RMX450Z	10-15	ZC35-4332	ZC35-4338
250SB	02-06	ZC35-4332	ZC35-4336
DR-Z400SM	04-16	ZC35-4332	ZC35-4336
KTM			
85SX	03-09	ZC35-4314	ZC35-4316
125-450 SX/SXF/EXC/ EXCF/XCF/XCW	08-17	ZC35-4332	ZC35-4338
HUSQVARNA			
FC/FE 250-450	14-17	ZC35-4332	ZC35-4338

CONTROL

BARCLAMP

LEVER

FOOT PARTS

HAND GUARD

BODY GUARD

BODY

ACCESSORIES

CARBON

Z-CARBON HEAD LIGHT ELIMINATOR

- Carbon head light eliminator to replace stock head light unit for reduced weight.
- Prevents mud from entering the head light shell.
- Designed for use in Enduro racing.

Bike	Year	Part #
CRF250X/450X	07-17	ZC45-1301
125-530EXC/EXC-F/XCF-W /XC-W(Six Days)	08-12	ZC45-1341



Z-CARBON FRONT BRAKE LINE CLAMP

- Universal front brake line guide on your number plate.
- Bolts and nuts included.
- * Holes need to be drilled on your front number plate for installation.

Part number
ZC47-3390

Z-CARBON STICKER



Part number Size
ZC50-0110 100 x 16 mm



Part number Size
ZC50-0120 60 x 36 mm



ASTELIGHT HUB

7-WHEEL

ASTELIGHT HUB

- Racing spec hubs for real MX and ED racing.
- Compatible hubs, designed to use with OE spokes, rims and wheel spacers.
- CNC machined from A6061-T6 forged aluminum.
- Light weight construction, lighter than OE hubs yet strong.
- Slant holes on the hubs to keep mud out from the hub body.
- Available in Black, Blue, Yellow, Green, Red and Orange colors.
- # Use OE or ZETA Wheel Spacers (P45) for installation.

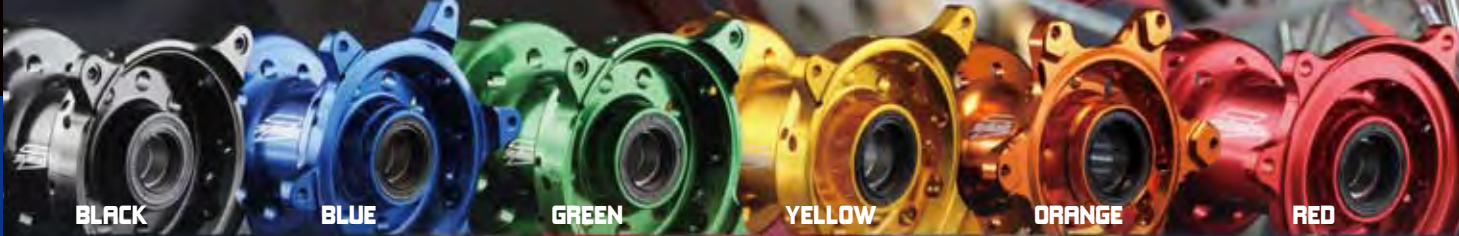

BLACK

BLUE

GREEN

YELLOW

ORANGE

RED

HONDA

FRONT HUB				
Bike	Year	Black	Red	
CR125R	95-07	W41-11111	W41-11113	
CR250R	95-07	W41-11111	W41-11113	
CRF250R	04-17	W41-11111	W41-11113	
CRF450R	02-17	W41-11111	W41-11113	
CRF450RX	17	W41-11111	W41-11113	
CRF250X #	04-17	W41-11111	W41-11113	
CRF450X #	05-17	W41-11111	W41-11113	
REAR HUB				
Bike	Year	Black	Red	
CR125R	02-07	W41-11211	W41-11213	
CR250R	00-07	W41-11211	W41-11213	
CRF250R	04-13	W41-11211	W41-11213	
	14-17	W41-11221	W41-11223	
CRF450R	02-12	W41-11211	W41-11213	
	13-17	W41-11221	W41-11223	
CRF450RX	17	W41-11221	W41-11223	
CRF250X	04-17	W41-11211	W41-11213	
CRF450X	05-17	W41-11211	W41-11213	

Meter gear cancel

YAMAHA

FRONT HUB				
Bike	Year	Black	Blue	
YZ125/250	02-17	W41-41111	W41-41112	
YZ250F	02-13	W41-41111	W41-41112	
	14-17	W41-41121	W41-41122	
YZ426F	02	W41-41111	W41-41112	
YZ450F	03-13	W41-41111	W41-41112	
	14-17	W41-41121	W41-41122	
YZ125X	17	W41-41111	W41-41112	
YZ250X	16-17	W41-41111	W41-41112	
YZ250FX	15-17	W41-41121	W41-41122	
YZ450FX	16-17	W41-41121	W41-41122	
WR250F #	02-17	W41-41111	W41-41112	
WR426F #	02	W41-41111	W41-41112	
WR450F #	03-16	W41-41111	W41-41112	
REAR HUB				
Bike	Year	Black	Blue	
YZ125/250	02-17	W41-41201	W41-41202	
YZ250F	02-08	W41-41201	W41-41202	
	09-17	W41-41211	W41-41212	
YZ426F	02	W41-41201	W41-41202	
YZ450F	03-08	W41-41201	W41-41202	
	09-17	W41-41211	W41-41212	
YZ125X	17	W41-41201	W41-41202	
YZ250X	16-17	W41-41201	W41-41202	
YZ250FX	15-17	W41-41201	W41-41202	
YZ450FX	16-17	W41-41201	W41-41202	
WR250F	02-17	W41-41201	W41-41202	
WR426F	02	W41-41201	W41-41202	
WR450F	02-16	W41-41201	W41-41202	

Meter gear cancel

KAWASAKI

FRONT HUB				
Bike	Year	Black	Green	Blue
KX125	06-08	W41-21111	W41-21114	W41-21112
KX250	06-08	W41-21111	W41-21114	W41-21112
KX250F	06-17	W41-21111	W41-21114	W41-21112
KX450F	06-17	W41-21111	W41-21114	W41-21112
KLX450R #	08-15	W41-21111	W41-21114	W41-21112
REAR HUB				
Bike	Year	Black	Green	Blue
KX125	03-08	W41-21211	W41-21214	W41-21212
KX250	03-08	W41-21211	W41-21214	W41-21212
KX250F	04-17	W41-21211	W41-21214	W41-21212
KX450F	06-17	W41-21211	W41-21214	W41-21212
KLX450R	08-15	W41-21211	W41-21214	W41-21212

Meter gear cancel

KTM

FRONT HUB				
Bike	Year	Black	Orange	
SX/SX-F 125-505	08-17	W41-51111	W41-51117	
XC/XC-F 150-525	08-17	W41-51111	W41-51117	
EXC/EXC-F 125-530	08-17	W41-51111	W41-51117	
XC-W/XCF-W 125-530	08-17	W41-51111	W41-51117	
450SMR	06-14	W41-51111	W41-51117	
REAR HUB				
Bike	Year	Black	Orange	
SX/SX-F 125-505	08-17	W41-51211	W41-51217	
XC/XC-F 150-525	08-17	W41-51211	W41-51217	
EXC/EXC-F 125-530	08-17	W41-51211	W41-51217	
XC-W/XCF-W 125-530	08-17	W41-51211	W41-51217	
450SMR	06-14	W41-51211	W41-51217	

HUSABERG

FRONT HUB				
Bike	Year	Black	Blue	
TE/FE125-650	08-14	W41-51111	W41-51112	
REAR HUB				
Bike	Year	Black	Blue	
TE/FE125-650	08-14	W41-51211	W41-51212	

HUSQVARNA

FRONT HUB				
Bike	Year	Black	Blue	
TE/FE125-501	14-17	W41-51111	W41-51112	
TC/FC125-450	14-17	W41-51111	W41-51112	
TX/FX125-450	17	W41-51111	W41-51112	
FS450	15-17	W41-51111	W41-51112	
REAR HUB				
Bike	Year	Black	Blue	
TE/FE125-501	14-17	W41-51211	W41-51212	
TC/FC125-450	14-17	W41-51211	W41-51212	
TX/FX125-450	17	W41-51211	W41-51212	
FS450	15-17	W41-51211	W41-51212	



Z-WHEEL

R50 RIM FRONT / REAR



- Real racing specification rim for ED and MX Racers.
- Made of A7050-T6 aluminum with special rim design for durability.
- Durable constructions yet light weight.
- Available wide rim lineup, latest competition bikes to older and dual sport models.
- Rims available for dual sport models, upgrade to high specification rims used by latest MX racing models.
- Available in Black, Silver, Burgundy Red, Prussian Blue and Green.

For the models with OE steel nipples, please replace them with Z-Wheel aluminum nipples.

Replace OE steel nipples with aluminum nipples to make our front and rear wheels weigh 150g lighter than OE wheels.

One hole each for rim lock and air valve on the rim.



BLACK

SILVER

BURGUNDY RED

PRUSSIAN BLUE

GREEN





R50 SERIES



1 Black 8 Silver 2 Prussian Blue 3 Burgundy Red 4 Green

Color Nipple lineup P59

Z-WHEEL R50 RIM FRONT [HONDA]

Bike	Year	Part.#	Rim Color. No #				Silver Nipple
			Black	Silver	Red	Green	
CR125R	*1 84-01	W01-9241	# 1	8	3	4	W31-P3368 *2
	02-07	W01-9241	# 1	8	3	4	W31-P3368 *2
CR250R	*1 84-01	W01-9241	# 1	8	3	4	W31-P3368 *2
	02-07	W01-9241	# 1	8	3	4	W31-P3368 *2
CR500R(US)	*1 84-01	W01-9241	# 1	8	3	4	W31-P3368 *2
CRF250R/X	04-17	W01-9241	# 1	8	3	4	W31-P3368 *2
CRF450R	02-17	W01-9241	# 1	8	3	4	W31-P3368 *2
CRF450RX	17	W01-9241	# 1	8	3	4	W31-P3368 *2
CRF450X	05-17	W01-9241	# 1	8	3	4	W31-P3368 *2
CRF230F(US)	*1 03-09	W01-9243	# 1	8	3	4	W31-P2368
CRF250L	*1 12-16	W01-9241	# 1	8	3	4	W31-P2368
CRM250R/AR	*1 89-98	W01-9243	# 1	8	3	4	W31-P2368
SL230	*1 97-01	W01-9243	# 1	8	3	4	W31-P2368
XL250 Degree	*1 91-95	W01-9243	# 1	8	3	4	W31-P2368
XLR125R	*1 93-94	W01-9243	# 1	8	3	4	W31-P2368
XLR200R	*1 93	W01-9243	# 1	8	3	4	W31-P2368
XLR250R/Baja	*1 88-94	W01-9243	# 1	8	3	4	W31-P2368
XR230	*1 05-12	W01-9243	# 1	8	3	4	W31-P2368
XR250L(US)	*1 91-96	W01-9243	# 1	8	3	4	W31-P2368
XR250R(US)	*1 84-89	W01-9241	# 1	8	3	4	W31-P3368 *2
XR250S/Baja	*1 90-04	W01-9243	# 1	8	3	4	W31-P3368 *2
XR250R(US)	*1 95-07	W01-9243	# 1	8	3	4	W31-P3368 *2
XR350R(US)	*1 84-85	W01-9241	# 1	8	3	4	W31-P3368 *2
XR400R(US)	*1 96-04	W01-9243	# 1	8	3	4	W31-P3368 *2
XR500R(US)	*1 83-84	W01-9241	# 1	8	3	4	W31-P3368 *2
XR600R(US)	*1 85-87	W01-9241	# 1	8	3	4	W31-P3368 *2
XR650R(US)	*1 88-00	W01-9243	# 1	8	3	4	W31-P3368 *2
XR650R(US)	*1 00-07	W01-9243	# 1	8	3	4	W31-P3368 *2

Z-WHEEL R50 RIM REAR [HONDA]

Bike	Year	Part.#	Rim Color. No #					Silver Nipple
			Black	Silver	Blue	Red	Green	
CR125R	95-96	W01-7331	# 1	8		3		W31-Q6328
	*1 97-01	W01-7331	# 1	8		3		W31-Q6328
	02-07	W01-7331	# 1	8		3		W31-Q6328
CR125R(wide)	*1 87-88	W01-6441	# 1	8	2	3	4	W31-Q4368 *2
	*1 89-93	W01-6431	# 1	8		3		W31-Q4328 *2
	94	W01-6431	# 1	8		3		W31-Q6328
CR250R	*1 87-88	W01-6441	# 1	8	2	3	4	W31-Q4368 *2
	*1 89-94	W01-6431	# 1	8		3		W31-Q4328 *2
	95-96	W01-7431	# 1	8		3		W31-Q6328
CR500R	*1 97-01	W01-7431	# 1	8		3		W31-Q6328
	02-07	W01-7431	# 1	8		3		W31-Q6328
	*1 87-88	W01-6441	# 1	8	2	3	4	W31-Q4368 *2
CRF250R	04-17	W01-7331	# 1	8		3		W31-Q4328 *2
CRF250X	04-17	W01-6431	# 1	8		3		W31-Q6328
CRF450R	02-17	W01-7431	# 1	8		3		W31-Q6328
CRF450RX	17	W01-7431	# 1	8		3		W31-Q6328
CRF450X	05-17	W01-6431	# 1	8		3		W31-Q6328
CRF250L	*1 12-16	W01-6431	# 1	8		3		W31-P2328
CRM250R/AR	*1 89-98	W01-6432	# 1	8		3		W31-P2328
XR230	*1 05-12	W01-6432	# 1	8		3		W31-P2328
XR250R(US)	*1 90-04	W01-6432	# 1	8		3		W31-P2328
XR250S/Baja	*1 89-98	W01-6432	# 1	8		3		W31-P2328
XR400R(US)	*1 96-04	W01-6432	# 1	8		3		W31-P3328 *2
XR600R(US)	*1 85-87	W01-6432	# 1	8		3		W31-P3328 *2
XR650R(US)	*1 91-00	W01-6432	# 1	8		3		W31-P3328 *2
XR650R(US)	*1 00-07	W01-6432	# 1	8		3		W31-P3328 *2

#Add rim color number to complete number for ordering.
*1 Z-WHEEL aluminum nipple set is required for installation.
*2 Color nipple available

Z-WHEEL R50 RIM FRONT [YAMAHA]

Bike	Year	Part.#	Rim Color. No #				Silver Nipple
			Black	Silver	Red	Green	
YZ125/250	86-17	W01-9241	# 1	8	3	4	W31-P3368 *2
YZ250F	01-17	W01-9241	# 1	8	3	4	W31-P3368 *2
YZ250WR	89-90	W01-9241	# 1	8	3	4	W31-P3368 *2
YZ400F	98-99	W01-9241	# 1	8	3	4	W31-P3368 *2
YZ426F	00-02	W01-9241	# 1	8	3	4	W31-P3368 *2
YZ450F	03-17	W01-9241	# 1	8	3	4	W31-P3368 *2
YZ125X	17	W01-9241	# 1	8	3	4	W31-P3368 *2
YZ250X	16-17	W01-9241	# 1	8	3	4	W31-P3368 *2
YZ250FX	15-17	W01-9241	# 1	8	3	4	W31-P3368 *2
YZ450FX	16-17	W01-9241	# 1	8	3	4	W31-P3368 *2
YZ490	89	W01-9241	# 1	8	3	4	W31-P3368 *2
DT125R	*1 85-97	W01-9241	# 1	8	3	4	W31-P2368
DT200R	*1 84-90	W01-9241	# 1	8	3	4	W31-P2368
DT200WR	*1 91-94	W01-9241	# 1	8	3	4	W31-P3368 *2
DT230 Lanza	*1 97-98	W01-9241	# 1	8	3	4	W31-P3368 *2
IT200(US)	*1 86	W01-9241	# 1	8	3	4	W31-P3368 *2
SEROW225	*1 85-04	W01-9241	# 1	8	3	4	W31-P2368
SEROW250	*1 05-16	W01-9241	# 1	8	3	4	W31-P2368
TT225(US)	*1 86-87	W01-9241	# 1	8	3	4	W31-P2368
TT350(US)	*1 86-87	W01-9241	# 1	8	3	4	W31-P3368 *2
TT600(US)	*1 85-86	W01-9241	# 1	8	3	4	W31-P3368 *2
TTR230(US)	*1 05-12	W01-9241	# 1	8	3	4	W31-P2368
TTR250/Raid	*1 93-97	W01-9241	# 1	8	3	4	W31-P3368 *2
TTR250(US)	*1 99-06	W01-9241	# 1	8	3	4	W31-P3368 *2
WR200R(US)	*1 92	W01-9241	# 1	8	3	4	W31-P3368 *2
WR250F	01-17	W01-9241	# 1	8	3	4	W31-P3368 *2
WR250R	*1 07-17	W01-9241	# 1	8	3	4	W31-P3368 *2
WR250Z	91-98	W01-9241	# 1	8	3	4	W31-P3368 *2
WR400F	98-00	W01-9241	# 1	8	3	4	W31-P3368 *2
WR426F	01-02	W01-9241	# 1	8	3	4	W31-P3368 *2
WR450F	03-16	W01-9241	# 1	8	3	4	W31-P3368 *2
WR500Z	92-93	W01-9241	# 1	8	3	4	W31-P3368 *2
XT225Serow(US)	*1 92-07	W01-9241	# 1	8	3	4	W31-P2368
XT250(US)	*1 08-12	W01-9241	# 1	8	3	4	W31-P2368
XT250T	*1 85	W01-9241	# 1	8	3	4	W31-P2368
XT350(US)	*1 85-00	W01-9241	# 1	8	3	4	W31-P2368

Z-WHEEL R50 RIM REAR [YAMAHA]

Bike	Year	Part.#	Rim Color. No #					Silver Nipple
			Black	Silver	Blue	Red	Green	
YZ125	*1 89-98	W01-7341	# 1	8		3	4	W31-Q4368 *2
	99-17	W01-7341	# 1	8		3	4	W31-Q4368 *2
YZ125(wide)	*1 88	W01-6441	# 1	8	2	3	4	W31-Q4368 *2
	*1 88	W01-6441	# 1	8	2	3	4	W31-Q4368 *2
YZ250	*1 89-98	W01-7441	# 1	8	2	3	4	W31-Q4368 *2
	99-17	W01-7441	# 1	8	2	3	4	W31-Q4368 *2
YZ250F	01-17	W01-7341	# 1	8		3	4	W31-Q4368 *2
YZ250WR	*1 89	W01-7441	# 1	8	2	3	4	W31-Q4368 *2
YZ250WR(US)	*1 90	W01-6441	# 1	8	2	3	4	W31-Q4368 *2
YZ400F	*1 98	W01-7441	# 1	8	2	3	4	W31-Q4368 *2
YZ426F	99	W01-7441	# 1	8	2	3	4	W31-Q4368 *2
YZ450F	00-02	W01-7441	# 1	8	2	3	4	W31-Q4368 *2
YZ450F	03-17	W01-7441	# 1	8	2	3	4	W31-Q4368 *2
YZ125X	17	W01-6441	# 1	8	2	3	4	W31-Q4368 *2
YZ250X	16-17	W01-6441	# 1	8	2	3	4	W31-Q4368 *2
YZ250FX	15-17	W01-6441	# 1	8	2	3	4	W31-Q4368 *2
YZ450FX	16-17	W01-6441	# 1	8	2	3	4	W31-Q4368 *2
DT200R	*1 88-90	W01-6441	# 1	8	2	3	4	W31-Q3368
DT200WR	*1 91-94	W01-6441	# 1	8	2	3	4	W31-Q4368 *2
DT230 Lanza	*1 97-98	W01-6441	# 1	8	2	3	4	W31-Q4368 *2
SEROW225	*1 93-96	W01-6441	# 1	8	2	3	4	W31-P2368
TTR250/Raid	*1 93-97	W01-6441	# 1	8	2	3	4	W31-Q4368 *2
WR200R(US)	*1 92	W01-6441	# 1	8	2	3	4	W31-Q4368 *2
WR250F	01-17	W01-6441	# 1	8	2	3	4	W31-Q4368 *2
WR250R	*1 07-17	W01-6441	# 1	8	2	3	4	W31-Q4368 *2
WR250Z(US)	*1 91-98	W01-6441	# 1	8	2	3	4	W31-Q4368 *2
WR400F	*1 98	W01-6441	# 1	8	2	3	4	W31-Q4368 *2
WR426F	99-00	W01-6441	# 1	8	2	3	4	W31-Q4368 *2
WR450F	01-02	W01-6441	# 1	8	2	3	4	W31-Q4368 *2
WR450F	03-16	W01-6441	# 1	8	2	3	4	W31-Q4368 *2

#Add rim color number to complete number for



Z-WHEEL
R50 RIM FRONT [KAWASAKI]

Bike	Year	Part #	Rim Color. No #				Silver Nipple		
			Black	Silver	Red	Green			
KX125	*1 82-83	W01-9241	#	1	8	3	4	W31-P3368	*2
	*1 90-98	W01-9241	#	1	8	3	4	W31-P3368	*2
	*1 99-05	W01-9241	#	1	8	3	4	W31-P4368	*2
KX250	06-08	W01-9241	#	1	8	3	4	W31-P3368	*2
	*1 82-83	W01-9241	#	1	8	3	4	W31-P3368	*2
	*1 90-98	W01-9241	#	1	8	3	4	W31-P3368	*2
KX250F	05-08	W01-9241	#	1	8	3	4	W31-P3368	*2
	04-17	W01-9241	#	1	8	3	4	W31-P3368	*2
SuperSherpa	06-17	W01-9241	#	1	8	3	4	W31-P3368	*2
SuperSherpa(US)	*1 97-07	W01-9241	#	1	8	3	4	W31-P3368	*2
KX500(US)	*1 00-09	W01-9241	#	1	8	3	4	W31-P3368	*2
KDX200(US)	*1 83-04	W01-9241	#	1	8	3	4	W31-P3368	*2
KDX200R	*1 86-06	W01-9241	#	1	8	3	4	W31-P3368	*2
KDX200SR	*1 89-90	W01-9241	#	1	8	3	4	W31-P3368	*2
KDX220R	*1 89-93	W01-9241	#	1	8	3	4	W31-P3368	*2
KDX220SR	*1 94-05	W01-9241	#	1	8	3	4	W31-P3368	*2
KDX250R	*1 94-99	W01-9241	#	1	8	3	4	W31-P3368	*2
KDX250SR	*1 91-94	W01-9241	#	1	8	3	4	W31-P3368	*2
KLX250	*1 91-94	W01-9241	#	1	8	3	4	W31-P3368	*2
KLX250ES	*1 91-94	W01-9241	#	1	8	3	4	W31-P3368	*2
KLX250R	*1 98-16	W01-9241	#	1	8	3	4	W31-P4368	*2
KLX250SR	*1 94-97	W01-9241	#	1	8	3	4	W31-P4368	*2
KLX250S(US)	*1 93-95	W01-9241	#	1	8	3	4	W31-P3368	*2
KLX250SR	*1 06-16	W01-9241	#	1	8	3	4	W31-P4368	*2
KLX300R	*1 93-94	W01-9241	#	1	8	3	4	W31-P3368	*2
KLX450R	*1 95-97	W01-9241	#	1	8	3	4	W31-P4368	*2
KLX650R(US)	*1 96-07	W01-9241	#	1	8	3	4	W31-P3368	*2
	08-15	W01-9241	#	1	8	3	4	W31-P3368	*2
	*1 93-96	W01-9241	#	1	8	3	4	W31-P3368	*2

#Add rim color number to complete number for ordering.
*1 Z-WHEEL aluminum nipple set is required for installation.
*2 Color nipple available

Z-WHEEL
R50 RIM REAR [KAWASAKI]

Bike	Year	Part #	Rim Color. No #					Silver Nipple		
			Black	Silver	Blue	Red	Green			
KX125	03-08	W01-7341	#	1	8		3	4	W31-Q4368	*2
KX125(wide)	*1 86-87	W01-6441	#	1	8	2	3	4	W31-Q3368	*2
	*1 88	W01-6441	#	1	8	2	3	4	W31-Q4368	*2
KX250	*1 86-87	W01-6441	#	1	8	2	3	4	W31-Q3368	*2
	*1 88	W01-6441	#	1	8	2	3	4	W31-Q4368	*2
KX250F	03-08	W01-7441	#	1	8	2	3	4	W31-Q4368	*2
	04-17	W01-7341	#	1	8		3	4	W31-Q4368	*2
KX450F	06-17	W01-7441	#	1	8	2	3	4	W31-Q4368	*2
KX500(US)	*1 86-87	W01-6441	#	1	8	2	3	4	W31-Q3368	*2
	*1 88	W01-6441	#	1	8	2	3	4	W31-Q3368	*2
SuperSherpa	*1 97-07	W01-6441	#	1	8	2	3	4	W31-Q3368	*2
SuperSherpa (US)	*1 00-09	W01-6441	#	1	8	2	3	4	W31-Q3368	*2
KDX200(US)	*1 95-06	W01-6443	#	1	8		3	4	W31-Q3368	*2
KDX220R	*1 94-05	W01-6443	#	1	8		3	4	W31-Q3368	*2
KDX220SR	*1 94-99	W01-6443	#	1	8		3	4	W31-Q3368	*2
KDX250(US)	*1 91-94	W01-6443	#	1	8		3	4	W31-Q4368	*2
KDX250SR	*1 91-94	W01-6443	#	1	8		3	4	W31-Q4368	*2
KLX250	*1 91	W01-6443	#	1	8		3	4	W31-Q3368	*2
	*1 92-94	W01-6443	#	1	8		3	4	W31-Q3368	*2
KLX250ES	*1 98-07	W01-6443	#	1	8		3	4	W31-Q3368	*2
	*1 08-16	W01-6443	#	1	8		3	4	W31-Q4368	*2
KLX250R	*1 94-97	W01-6443	#	1	8		3	4	W31-Q3368	*2
KLX250SR	*1 93-95	W01-6443	#	1	8		3	4	W31-Q3368	*2
KLX250S(US)	*1 94-96	W01-6443	#	1	8		3	4	W31-Q3368	*2
KLX250SR	*1 06-08	W01-6443	#	1	8		3	4	W31-Q3368	*2
	*1 09-16	W01-6443	#	1	8		3	4	W31-Q4368	*2
KLX300R	*1 93-97	W01-6443	#	1	8		3	4	W31-Q3368	*2
KLX450R	*1 96-07	W01-6443	#	1	8		3	4	W31-Q3368	*2
KLX650R(US)	08-15	W01-6443	#	1	8	2	3	4	W31-Q4368	*2
	*1 93	W01-6443	#	1	8		3	4	W31-Q4368	*2

Z-WHEEL
R50 RIM REAR [SUZUKI]

Bike	Year	Part #	Rim Color. No #					Silver Nipple		
			Black	Silver	Blue	Red	Green			
RM125	90-06	W01-7341	#	1	8		3	4	W31-Q4368	*2
	07-08	W01-7341	#	1	8		3	4	W31-Q6368	*2
RM250	90-06	W01-7441	#	1	8	2	3	4	W31-Q4368	*2
	07-08	W01-7441	#	1	8	2	3	4	W31-Q6368	*2
RMZ250	04-06	W01-7341	#	1	8		3	4	W31-Q4368	*2
	07-17	W01-7341	#	1	8		3	4	W31-Q6368	*2
RMZ450	05	W01-7441	#	1	8	2	3	4	W31-Q4368	*2
	06-17	W01-7441	#	1	8	2	3	4	W31-Q6368	*2
RMX250(US)	89-98	W01-6441	#	1	8	2	3	4	W31-Q4368	*2
	89-98	W01-6441	#	1	8	2	3	4	W31-Q6368	*2
RMX250S	*1 92-98	W01-6441	#	1	8	2	3	4	W31-Q3368	*2
	10-16	W01-6441	#	1	8	2	3	4	W31-Q6368	*2
TS125R	*1 89-97	W01-6441	#	1	8	2	3	4	W31-Q3368	*2
	*1 89-96	W01-6441	#	1	8	2	3	4	W31-Q6368	*2
DR125	*1 86-88	W01-9241	#	1	8	3	4	W31-P2368	*2	
DR125SE	*1 93-99	W01-9241	#	1	8	3	4	W31-P2368	*2	
DR200	*1 86-87	W01-9241	#	1	8	3	4	W31-P2368	*2	
DR200SE	*1 93-09	W01-9241	#	1	8	3	4	W31-P2368	*2	
DR250	*1 85	W01-9241	#	1	8	3	4	W31-P3368	*2	
DR250R	95-00	W01-9241	#	1	8	3	4	W31-P3368	*2	
DR250RX	96-00	W01-9241	#	1	8	3	4	W31-P3368	*2	
DR250S	*1 90-93	W01-9241	#	1	8	3	4	W31-P3368	*2	
DR250SES	*1 90-95	W01-9241	#	1	8	3	4	W31-P3368	*2	
DR350SE	*1 90-99	W01-9241	#	1	8	3	4	W31-P3368	*2	
DRZ250(US)	01-07	W01-9241	#	1	8	3	4	W31-P3368	*2	
DRZ400(US)	00-04	W01-9241	#	1	8	3	4	W31-P3368	*2	
DRZ400E	00-07	W01-9241	#	1	8	3	4	W31-P3368	*2	
DRZ400S	00-08	W01-9241	#	1	8	3	4	W31-P3368	*2	
DRZ400S(US)	00-16	W01-9241	#	1	8	3	4	W31-P3368	*2	
RA125	*1 84-88	W01-9241	#	1	8	3	4	W31-P2368	*2	
RH250	*1 84-88	W01-9241	#	1	8	3	4	W31-P3368	*2	

#Add rim color number to complete number for ordering.
*1 Z-WHEEL aluminum nipple set is required for installation.
*2 Color nipple available

Z-WHEEL
R50 RIM FRONT [HUSQVARNA]

Bike	Year	Part #	Rim Color. No #				Silver Nipple	
			Black	Silver	Red	Green		
TC/FC 125-450	*1 14-17	W01-9241	#	1	8	3	4	W31-P5368
TE/FE 250-501	*1 14-17	W01-9241	#	1	8	3	4	W31-P5368
TX/FX125-450	*1 17	W01-9241	#	1	8	3	4	W31-P5368

#Add rim color number to complete number for ordering.
*1 Z-WHEEL aluminum nipple set is required for installation.

Z-WHEEL
R50 RIM REAR [HUSQVARNA]

Bike	Year	Part #	Rim Color. No #					Silver Nipple	
			Black	Silver	Blue	Red	Green		
TC/FC 125-450	*1 14-17	W01-7441	#	1	8	2	3	4	W31-Q5368
TE/FE 250-501	*1 14-17	W01-6441	#	1	8	2	3	4	W31-Q5368
TX/FX125-450	*1 17	W01-6441	#	1	8	2	3	4	W31-Q5368

Z-WHEEL
R50 RIM FRONT [HUSABERG]

Bike	Year	Part #	Rim Color. No #				Silver Nipple	
			Black	Silver	Red	Green		
FE250-650	*1 07-14	W01-9241	#	1	8	3	4	W31-P5368
TE125-300	*1 11-14	W01-9241	#	1	8	3	4	W31-P5368

#Add rim color number to complete number for ordering.
*1 Z-WHEEL aluminum nipple set is required for installation.

Z-WHEEL
R50 RIM REAR [HUSABERG]

Bike	Year	Part #	Rim Color. No #					Silver Nipple	
			Black	Silver	Blue	Red	Green		
FE250-550/650	*1 07-11	W01-6441	#	1	8	2	3	4	W31-Q7368
	*1 12-14	W01-6441	#	1	8	2	3	4	W31-Q5368
FE570	*1 09-10	W01-6441	#	1	8	2	3	4	W31-Q7368
	*1 11-12	W							



Z-WHEEL

R50 SPOKE SET



- Spoke set designed for Z-wheel rims.

FRONT

Bike	Year	R50 Spork set F	Silver nipple
HONDA			
CR125R	95-07	W10-10001	
CR250R	95-07	W10-10001	
CRF250R	04-17	W10-10001	
CRF450R	02-17	W10-10001	
CRF450RX	17	W10-10001	
CRF250X	04-17	W10-10001	
CRF450X	05-17	W10-10001	
CRF250L	12-16	W10-10018	
CRM250R/AR	89-98	W10-10007	
SL230	97-01	W10-10007	
XL250 Degree	91-95	W10-10007	
XLR125R	93-94	W10-10007	
XLR200R	93	W10-10007	
XLR250R/ Baja	88-94	W10-10007	
XR230	05-12	W10-10007	
XR250S/Baja	95-07	W10-10007	
XR250R	90-04	W10-10020	
XR400R	96-04	W10-10020	
XR600R	88-00	W10-10020	
XR650R	00-07	W10-10020	
YAMAHA			
YZ125	92-17	W10-50001	
YZ250	92-17	W10-50001	
YZ250F	01-17	W10-50001	
YZ400F	98-99	W10-50001	
YZ426F	00-02	W10-50001	
YZ450F	03-17	W10-50001	
YZ125X	17	W10-50001	
YZ250X	16-17	W10-50001	
YZ250FX	15-17	W10-50001	
YZ450FX	16-17	W10-50001	
WR250F	01-17	W10-50001	
WR250Z	92-98	W10-50001	
WR400F	98-00	W10-50001	
WR426F	01-02	W10-50001	
WR450F	03-16	W10-50001	
DT230 Lanza	97-98	W10-10001	
WR250R	07-17	W10-70003	
TTR250/Raid	93-97	W10-10001	
KAWASAKI			
KX125	06-08	W10-90001	
KX250	06-08	W10-90001	
KX250F	06-17	W10-90001	
KX450F	06-17	W10-90001	
KLX250SR	95-97	W10-30006	
KLX250ES	94-97	W10-30006	
KLX250	98-16	W10-30006	
KLX450R	08-15	W10-90001	
SUZUKI			
RM125	90-08	W10-90001	
RM250	90-08	W10-90001	
RMZ250	07-17	W10-50001	
RMZ450	05-17	W10-50001	
RMX250R	89-98	W10-90001	
RMX250S	92-98	W10-90001	
RMX450Z	10-16	W10-50001	
DR250R	95-00	W10-90001	
DR250RX	96-00	W10-90001	
DRZ400	00-04	W10-50013	
DRZ400E	00-07	W10-50013	
DRZ400S	00-08	W10-50013	
DRZ400S(USA)	00-16	W10-50013	
Bike	Year	R50 Spork set F	Silver nipple
KTM			
SX/SX-F 125-505	05-17	W10-90001 #1	W31-P3368 #2
XC/XC-F 150-525	05-17	W10-90001 #1	W31-P3368 #2
EXC/EXC-F 125-530	05-17	W10-90001 #1	W31-P3368 #2
XC-W/XCF-W 125-530	05-17	W10-90001 #1	W31-P3368 #2
HUSABERG			
TE/FE125-650	07-14	W10-90001 #1	W31-P3368 #2
HUSQVARNA			
TC/FC 125-450	14-17	W10-90001 #1	W31-P3368 #2
TE/FE 125-501	14-17	W10-90001 #1	W31-P3368 #2
TX/FX125-450	17	W10-90001 #1	W31-P3368 #2

REAR

Bike	Year	R50 Spork set R	Silver nipple
HONDA			
CR125R	03-07	W10-10008 #1	W31-Q4328 #2
CR250R	03-07	W10-10008 #1	W31-Q4328 #2
CRF250R	04-17	W10-10008 #1	W31-Q4328 #2
CRF450R	03-17	W10-10008 #1	W31-Q4328 #2
CRF450RX	17	W10-10008 #1	W31-Q4328 #2
CRF250X	04-17	W10-11891 #1	W31-Q4328 #2
CRF450X	05-17	W10-11891 #1	W31-Q4328 #2
CRF250L	12-16	W10-10019	
CRM250R/AR	89-98	W10-10016	
XR230	05-12	W10-10016	
XR250S/Baja	95-07	W10-10016	
XR250R	90-04	W10-10016	
XR400R	96-04	W10-10021	
XR600R	91-00	W10-10021	
XR650R	00-07	W10-10021	
Bike	Year	R50 Spork set R	Silver nipple
YAMAHA			
YZ125	99-17	W10-70008	
YZ250	99-17	W10-70008	
YZ250F	01-08	W10-70008	
	09-17	W10-70007	
YZ400F	99	W10-70008	
YZ426F	00-02	W10-70008	
YZ450F	03-08	W10-70008	
	09-17	W10-70007	
YZ125X	17	W10-71890	
YZ250X	16-17	W10-71890	
YZ250FX	15-17	W10-71890	
YZ450FX	16-17	W10-71890	
WR250F	01-17	W10-71890	
WR400F	99-00	W10-71890	
WR426F	01-02	W10-71890	
WR450F	03-16	W10-71890	
WR250R	07-17	W10-70011	
KAWASAKI			
KX125	03-08	W10-30010	
KX250	03-08	W10-30010	
KX250F	04-17	W10-30010	
KX450F	06-17	W10-30010	
KLX250R	93-95	W10-30015	
KLX300R	96-05	W10-30015	
KLX450R	08-15	W10-31890	
KLX650R	93	W10-30015	
KLX250SR	93-97	W10-30015	
KLX250ES	94-97	W10-30015	
	98-07	W10-30015	
KLX250	08-16	W10-30018	
Bike	Year	R50 Spork set R	Silver nipple
SUZUKI			
RM125	90-06	W10-50005	
	07-08	W10-50005 #1	W31-Q4368 #2
RM250	90-06	W10-50005	
	07-08	W10-50005 #1	W31-Q4368 #2
RMZ250	04-06	W10-30010	
	07-17	W10-50004 #1	W31-Q4368 #2
RMZ450	05-17	W10-50004 #1	W31-Q4368 #2
RMX450Z	10-16	W10-51890 #1	W31-Q4368 #2
RMX250S	92-98	W10-50010	
DRZ400S	04-08	W10-50008	
Bike	Year	R50 Spork set R	Silver nipple
KTM			
SX/SX-F 125-505	05-17	W10-90020 #1	W31-Q4368 #2
XC/XC-F 150-525	05-17	W10-91890 #1	W31-Q4368 #2
EXC/EXC-F 125-530	05-17	W10-91890 #1	W31-Q4368 #2
XC-W/XCF-W 125-530	05-17	W10-91890 #1	W31-Q4368 #2
HUSABERG			
TE/FE125-650	07-14	W10-91890 #1	W31-Q4368 #2
HUSQVARNA			
TC/FC 125-450	14-17	W10-90020 #1	W31-Q4368 #2
TE/FE 125-501	14-17	W10-91890 #1	W31-Q4368 #2
TX/FX125-450	17	W10-91890 #1	W31-Q4368 #2

#1 Listed nipple set is required for installation of Z-Wheel spoke set.
#2 Color nipple available (Black, Blue, Red, Green, Gold)



BLACK

SILVER

BLUE

RED

GREEN

GOLD

Z-WHEEL

ALUMINIUM NIPPLE SET



- OE replacement aluminum nipple set, available in silver, black, blue, red, green and gold anodized nipples.
 - Many application available for MX and ED bikes.

Aluminium Nipple Set (Front)

Bike	Year	Part #	Color No. #						
			Black	Silver	Blue	Red	Green	Gold	
HONDA									
CR125R	02-07	W31-P336	#	1	8	2	3	4	5
CR250R	02-07	W31-P336	#	1	8	2	3	4	5
CRF250R	04-17	W31-P336	#	1	8	2	3	4	5
CRF250X	04-17	W31-P336	#	1	8	2	3	4	5
CRF450R	02-17	W31-P336	#	1	8	2	3	4	5
CRF450RX	17	W31-P336	#	1	8	2	3	4	5
CRF450X	05-17	W31-P336	#	1	8	2	3	4	5
YAMAHA									
WR250F	01-17	W31-P336	#	1	8	2	3	4	5
WR250Z	91-98	W31-P336	#	1	8	2	3	4	5
WR400F	98-00	W31-P336	#	1	8	2	3	4	5
WR426F	01-02	W31-P336	#	1	8	2	3	4	5
WR450F	03-15	W31-P336	#	1	8	2	3	4	5
WR500Z	92-93	W31-P336	#	1	8	2	3	4	5
YZ125	86-17	W31-P336	#	1	8	2	3	4	5
YZ250	86-17	W31-P336	#	1	8	2	3	4	5
YZ250F	01-17	W31-P336	#	1	8	2	3	4	5
YZ250WR	89-90	W31-P336	#	1	8	2	3	4	5
YZ400F	98-99	W31-P336	#	1	8	2	3	4	5
YZ426F	00-02	W31-P336	#	1	8	2	3	4	5
YZ450F	03-17	W31-P336	#	1	8	2	3	4	5
YZ125X	17	W31-P336	#	1	8	2	3	4	5
YZ250FX	15-17	W31-P336	#	1	8	2	3	4	5
YZ450FX	16-17	W31-P336	#	1	8	2	3	4	5
YZ490	86-90	W31-P336	#	1	8	2	3	4	5
KAWASAKI									
KX125	99-05	W31-Q436	#	1	8	2	3	4	5
KX250	99-04	W31-Q436	#	1	8	2	3	4	5
KX250F	04-17	W31-P336	#	1	8	2	3	4	5
KX450F	06-17	W31-P336	#	1	8	2	3	4	5
KLX450R	08-15	W31-P336	#	1	8	2	3	4	5
SUZUKI									
DRZ400S	00-08	W31-P336	#	1	8	2	3	4	5
DRZ400S(US)	00-16	W31-P336	#	1	8	2	3	4	5
DRZ400SM	05-08	W31-P336	#	1	8	2	3	4	5
DRZ400SM(US)	05-16	W31-P336	#	1	8	2	3	4	5
DRZ400(US)	00-04	W31-P336	#	1	8	2	3	4	5
DRZ400E(US)	00-07	W31-P336	#	1	8	2	3	4	5
DRZ400E	07	W31-P336	#	1	8	2	3	4	5
DR250R	95-00	W31-P336	#	1	8	2	3	4	5
DR250RX	96-00	W31-P336	#	1	8	2	3	4	5
DRZ250(US)	01-07	W31-P336	#	1	8	2	3	4	5
RMX250R	93-98	W31-P336	#	1	8	2	3	4	5
RMX250R(US)	89-98	W31-P336	#	1	8	2	3	4	5
RMX450Z	10-16	W31-P336	#	1	8	2	3	4	5
RM125	86-08	W31-P336	#	1	8	2	3	4	5
RM250	86-08	W31-P336	#	1	8	2	3	4	5
RMZ250	04-17	W31-P336	#	1	8	2	3	4	5
RMZ450	05-17	W31-P336	#	1	8	2	3	4	5

Aluminium Nipple Set (Rear)

Bike	Year	Part #	Color No. #						
			Black	Silver	Blue	Red	Green	Gold	
HONDA									
CR125R	94-96	W31-Q632	#	1	8				
	02-07	W31-Q632	#	1	8				
	95-96	W31-Q632	#	1	8				
CR250R	02-07	W31-Q632	#	1	8				
CRF250R	04-17	W31-Q632	#	1	8				
CRF250X	04-17	W31-Q632	#	1	8				
CRF450R	02-17	W31-Q632	#	1	8				
CRF450RX	17	W31-Q632	#	1	8				
YAMAHA									
WR250F	01-17	W31-Q436	#	1	8	2	3	4	5
WR400F	99-00	W31-Q436	#	1	8	2	3	4	5
WR426F	01-02	W31-Q436	#	1	8	2	3	4	5
WR450F	03-16	W31-Q436	#	1	8	2	3	4	5
YZ125	99-17	W31-Q436	#	1	8	2	3	4	5
YZ250	99-17	W31-Q436	#	1	8	2	3	4	5
YZ250F	01-17	W31-Q436	#	1	8	2	3	4	5
YZ400F	99	W31-Q436	#	1	8	2	3	4	5
YZ426F	00-02	W31-Q436	#	1	8	2	3	4	5
YZ450F	03-17	W31-Q436	#	1	8	2	3	4	5
YZ125X	17	W31-Q436	#	1	8	2	3	4	5
YZ250FX	16-17	W31-Q436	#	1	8	2	3	4	5
YZ450FX	16-17	W31-Q436	#	1	8	2	3	4	5
CRF450X	05-17	W31-Q632	#	1	8	2	3	4	5
KAWASAKI									
KX125	99-08	W31-Q436	#	1	8	2	3	4	5
KX250	99-08	W31-Q436	#	1	8	2	3	4	5
KX250F	04-17	W31-Q436	#	1	8	2	3	4	5
KX450F	06-17	W31-Q436	#	1	8	2	3	4	5
KLX450R	08-15	W31-Q436	#	1	8	2	3	4	5
SUZUKI									
DRZ400S	00-08	W31-Q436	#	1	8	2	3	4	5
DRZ400S(US)	00-16	W31-Q436	#	1	8	2	3	4	5
DRZ400SM	05-08	W31-Q436	#	1	8	2	3	4	5
DRZ400SM(US)	05-16	W31-Q436	#	1	8	2	3	4	5
DRZ400(US)	00-04	W31-Q436	#	1	8	2	3	4	5
DRZ400E(US)	00-07	W31-Q436	#	1	8	2	3	4	5
DRZ400E	07	W31-Q436	#	1	8	2	3	4	5
DR250R	95-00	W31-P336	#	1	8	2	3	4	5
DR250RX	96-00	W31-P336	#	1	8	2	3	4	5
DRZ250(US)	01-07	W31-P336	#	1	8	2	3	4	5
RMX250R	90-98	W31-Q436	#	1	8	2	3	4	5
RMX250R(US)	89-98	W31-Q436	#	1	8	2	3	4	5
RMX450Z	10-16	W31-Q636	#	1	8				
RM125	86-06	W31-Q436	#	1	8	2	3	4	5
RM250	07-08	W31-Q636	#	1	8				
RMZ250	04-06	W31-Q436	#	1	8	2	3	4	5
RMZ450	05	W31-Q436	#	1	8	2	3	4	5
	06-17	W31-Q636	#	1	8				

Bike	Year	Silver nipple
KTM		
SX/SX-F 125-505	05-17	W31-P5368
XC/XC-F 150-525	05-17	W31-P5368
EXC/EXC-F 125-530	05-17	W31-P5368
XC-W/XCF-W 125-530	05-17	W31-P5368
HUSABERG		
FE250-650	07-14	W31-P5368
TE125-300	11-14	W31-P5368
HUSQVARNA		
TC/FC 125-450/S	14-17	W31-P5368
TE/FE 125-501	14-17	W31-P5368
TX/FX125-450	17	W31-P5368

Bike	Year	Silver nipple
KTM		
SX/SX-F 125-505	05-10	W31-Q7368
	11-17	W31-Q5368
XC/XC-F 150-525	05-10	W31-Q7368
	11-17	W31-Q5368
EXC/EXC-F 125-530	05-11	W31-Q7368
	12-17	W31-Q5368
XC-W/XCF-W 125-530	05-11	W31-Q7368
	12-17	W31-Q5368
HUSABERG		
FE250-550/650	07-11	W31-Q7368
	12-14	W31-Q5368
FE570	09-10	W31-Q7368
	11-12	W31-Q5368
TE125-300	11	W31-Q7368
	12-14	W31-Q5368
HUSQVARNA		
TC/FC 125-450/S	14-17	W31-Q5368
TE/FE 125-501	14-17	W31-Q5368
TX/FX125-450	17	W31-Q5368



M50 SERIES

Convertible Supermotard rim kit

into 16.5 / 17 inch



The front wheel uses cross-spoke (excluding trail). Minimizing the interference of the caliper and spoke.



Compatible with genuine hub

Z-WHEEL

M50 MOTARD RIM



- Kit to convert motocross bike into motard front 16.5 inch, rear 17 inch.
- Lineup of 17 inch standard front and rear wheels for the trail.
- Designed for a high-rigidity rim "M50 series" Supermotard.
- The front rim adopts cross spokes (excluding trails), minimized interference caliper and spoke.
- Minimum required parts.

Kit : M50 Rim Black (one side 1 wheel minute) / Stainless spoke set / Aluminium nipple set (Silver)



Bike	Year	Motard Rim Set Front		Front Replacement parts			Motard Rim Set Rear		Rear Replacement parts		
		Size	Part #	Rim	Spoke set	Nipple set (Silver) *1	Size	Part #	Rim	Spoke set	Nipple set (Silver) *1
HONDA											
CR125R/250R	95-07	16.5x3.50	W26-11011	W03-47411	W13-11011	W31-P3368	-	-	-	-	-
CRF250R	04-17	16.5x3.50	W26-11011	W03-47411	W13-11011	W31-P3368	-	-	-	-	-
CRF450R	02-17	16.5x3.50	W26-11011	W03-47411	W13-11011	W31-P3368	-	-	-	-	-
CRF450RX	17	16.5x3.50	W26-11011	W03-47411	W13-11011	W31-P3368	-	-	-	-	-
CRF250X	04-17	16.5x3.50	W26-11011	W03-47411	W13-11011	W31-P3368	-	-	-	-	-
CRF450X	05-17	16.5x3.50	W26-11011	W03-47411	W13-11011	W31-P3368	-	-	-	-	-
YAMAHA											
YZ125/250	02-17	16.5x3.50	W26-17011	W03-47411	W13-17011	W31-P3368	17x5.00	W26-27111	W03-5A411	W13-27111	W31-Q4368
YZ250F	09-17	16.5x3.50	W26-17011	W03-47411	W13-17011	W31-P3368	17x5.00	W26-27011	W03-5A411	W13-27011	W31-Q4368
	02-08	16.5x3.50	W26-17011	W03-47411	W13-17011	W31-P3368	17x5.00	W26-27111	W03-5A411	W13-27111	W31-Q4368
	09-17	16.5x3.50	W26-17011	W03-47411	W13-17011	W31-P3368	17x5.00	W26-27011	W03-5A411	W13-27011	W31-Q4368
	03-08	16.5x3.50	W26-17011	W03-47411	W13-17011	W31-P3368	17x5.00	W26-27111	W03-5A411	W13-27111	W31-Q4368
YZ426F	02	16.5x3.50	W26-17011	W03-47411	W13-17011	W31-P3368	17x5.00	W26-27111	W03-5A411	W13-27111	W31-Q4368
YZ250FX	15-17	16.5x3.50	W26-17011	W03-47411	W13-17011	W31-P3368	17x5.00	W26-27111	W03-5A411	W13-27111	W31-Q4368
YZ450FX	16-17	16.5x3.50	W26-17011	W03-47411	W13-17011	W31-P3368	17x5.00	W26-27111	W03-5A411	W13-27111	W31-Q4368
YZ125X	17	16.5x3.50	W26-17011	W03-47411	W13-17011	W31-P3368	17x5.00	W26-27111	W03-5A411	W13-27111	W31-Q4368
YZ250X	16-17	16.5x3.50	W26-17011	W03-47411	W13-17011	W31-P3368	17x5.00	W26-27111	W03-5A411	W13-27111	W31-Q4368
WR250F	02-17	16.5x3.50	W26-17011	W03-47411	W13-17011	W31-P3368	17x5.00	W26-27111	W03-5A411	W13-27111	W31-Q4368
WR426F	02	16.5x3.50	W26-17011	W03-47411	W13-17011	W31-P3368	17x5.00	W26-27111	W03-5A411	W13-27111	W31-Q4368
WR450F	03-16	16.5x3.50	W26-17011	W03-47411	W13-17011	W31-P3368	17x5.00	W26-27111	W03-5A411	W13-27111	W31-Q4368
WR250R	07-17	17x3.50	W26-17511	W03-57411	W13-17511	W31-P3368	17x4.50	W26-27511	W03-59411	W13-27511	W31-Q4368
WR250X	07-17	-	-	-	-	-	17x4.50	W26-27511	W03-59411	W13-27511	W31-Q4368
KAWASAKI											
KLX250	98-16	17x3.50	W26-13511	W03-57411	W13-13511	W31-P3368	17x4.50	W26-23511	W03-59421	W13-23511	W31-Q4368
KLX250ES	94-97	17x3.50	W26-13511	W03-57411	W13-13511	W31-P3368	17x4.50	W26-23511	W03-59421	W13-23511	W31-Q4368
KLX250R	93-95	17x3.50	W26-13511	W03-57411	W13-13511	W31-P3368	17x4.50	W26-23511	W03-59421	W13-23511	W31-Q4368
KLX250SR	93-97	17x3.50	W26-13511	W03-57411	W13-13511	W31-P3368	17x4.50	W26-23511	W03-59421	W13-23511	W31-Q4368
KLX300R	96-07	17x3.50	W26-13511	W03-57411	W13-13511	W31-P3368	17x4.50	W26-23511	W03-59421	W13-23511	W31-Q4368
KLX650R	93-96	17x3.50	W26-13511	W03-57411	W13-13511	W31-P3368	17x4.50	W26-23511	W03-59421	W13-23511	W31-Q4368
D-TRACCKER/X	98-16	17x3.50	W26-13511	W03-57411	W13-13511	W31-P3368	17x4.50	W26-23511	W03-59421	W13-23511	W31-Q4368
SUZUKI											
RMZ250	07-17	16.5x3.50	W26-15011	W03-47411	W13-15011	W31-P3368	17x5.00	W26-25011	W03-5A411	W13-25011	W31-Q4368
RMZ450	05-17	16.5x3.50	W26-15011	W03-47411	W13-15011	W31-P3368	17x5.00	W26-25011	W03-5A411	W13-25011	W31-Q4368
RMX450Z	10-16	16.5x3.50	W26-15011	W03-47411	W13-15011	W31-P3368	17x5.00	W26-25011	W03-5A411	W13-25011	W31-Q4368
KTM											
SX/SX-F 125-505	08-17	16.5x3.50	W26-19011	W03-47411	W13-19011	W31-P3368	17x5.00	W26-29031	W03-5A411	W13-29031	W31-Q4368
XC/XC-F 150-525	08-17	16.5x3.50	W26-19011	W03-47411	W13-19011	W31-P3368	17x5.00	W26-29031	W03-5A411	W13-29031	W31-Q4368
EXC/-F 125-530	08-17	16.5x3.50	W26-19011	W03-47411	W13-19011	W31-P3368	17x5.00	W26-29031	W03-5A411	W13-29031	W31-Q4368
XC/F-W 200-530	08-17	16.5x3.50	W26-19011	W03-47411	W13-19011	W31-P3368	17x5.00	W26-29031	W03-5A411	W13-29031	W31-Q4368
450SMR	08-14	16.5x3.50	W26-19011	W03-47411	W13-19011	W31-P3368	17x5.00	W26-29031	W03-5A411	W13-29031	W31-Q4368
HUSABERG											
TE/FE125-650	08-14	16.5x3.50	W26-19011	W03-47411	W13-19011	W31-P3368	17x5.00	W26-29031	W03-5A411	W13-29031	W31-Q4368
HUSQVARNA											
TE/FE125-501/S	14-17	16.5x3.50	W26-19011	W03-47411	W13-19011	W31-P3368	17x5.00	W26-29031	W03-5A411	W13-29031	W31-Q4368
TC/FC125-450	14-17	16.5x3.50	W26-19011	W03-47411	W13-19011	W31-P3368	17x5.00	W26-29031	W03-5A411	W13-29031	W31-Q4368
TX/FX125-450	17	16.5x3.50	W26-19011	W03-47411	W13-19011	W31-P3368	17x5.00	W26-29031	W03-5A411	W13-29031	W31-Q4368
FS450	15-17	16.5x3.50	W26-19011	W03-47411	W13-19011	W31-P3368	17x5.00	W26-29031	W03-5A411	W13-29031	W31-Q4368

*Rim set comes with Silver aluminum nipples.

*1 Optional color nipples are available.



GENUINE / EXCELSIOR / D.I.D RIM

Bike	Year	Part #
HONDA		
CRF250L/M	12-16	W16-31011
CRM250R/AR	89-98	W16-31021
XR230/motard	05-12	W16-31021
XR250S/BAJA/motard	95-07	W16-31021
XR400motard	05-08	W16-31021
XR250R	90-04	W16-31021
XR400R	96-04	W16-31021
XR650R	00-07	W16-31021
YAMAHA		
DT200WR	91-94	W16-37011
DT230LANZA	97-98	W16-37021
TT250R/RAID	93-97	W16-37021
WR250R	07-17	W16-37031
WR250X	07-17	W16-37041
SUZUKI		
RMX250S	92-98	W16-35011
DR-Z400S	00-03	W16-35031
	04-08	W16-35041
DR-Z400SM #1	05-09	W16-35041
DR-Z400SM(USA) #1	05-16	W16-35041

Bike	Year	Part #
KAWASAKI		
KDX125SR	90-99	W16-33011
KDX200R	89-90	W16-33011
KDX200SR	90-93	W16-33011
KDX220R	94-05	W16-33011
KDX220SR	94-99	W16-33011
KDX250R	91-94	W16-33011
KDX250SR	91-94	W16-33011
KLX250	98-16	W16-33021
KLX250ES	94-97	W16-33021
KLX250R	93-95	W16-33021
KLX250SR	93-97	W16-33021
KLX300R	96-07	W16-33021
KLX650R	93-96	W16-33021
D-TRACKER/X	98-16	W16-33021

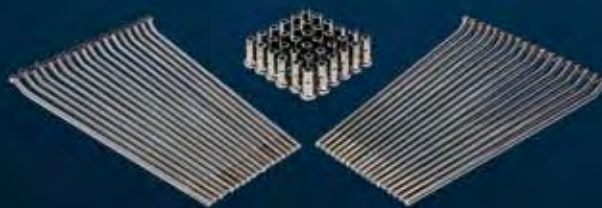

Z-WHEEL

**GENUINE / EXCELSIOR / D.I.D RIM
CORRESPONDING MOTARD SPOKE SET
17 INCHES**



- Replacement line up to be used on motorcycles with Excelsior / D.I.D rim and 17-inch wheels for Genuine.
- Stainless steel (except for some models) spoke and stainless nipple used for excellent corrosion resistance.
- 72 lines / nipple 72 pieces for both front and rear spoke set
- * both front and rear set for 68 lines / 68 pcs CRF250L / M, XR system models.
- Non applicable for M50 rim

#1 Aluminium nipple



S30 SERIES



Z-WHEEL

S30 RIM FRONT / REAR



- Real racing specification rims for small wheel bikes.
- Made of 7000 grade aluminum with special rim design for durability.
- Durable construction yet lightweight.
- Available in wide rim line up, recent competition bikes to older and dual sport models.
- Rims available for dual sport models to upgrade the rims.
- Can be used with OE nipples.
- One each of rim lock and air valve holes on the rim.
- Available in Black color.

FRONT RIM

	Bike	Year	17inch	19inch
H	CR80R/85R/R2	96-07	W02-51211	W02-71211
	CRF150R/R2	07-17	W02-51211	W02-71211
	CRF125F	14-17	-	W02-71411
	CRM50/80	93-97	W02-51211	-
Y	YZ80/85/LW	94-17	W02-51311	W02-71311
	TT-R125LW	00-11	-	W02-71411
K	KX80/85/II/100	98-17	W02-51211	W02-71211
	KLX125/150S	09-16	-	W02-71211
S	RM85/L	04-16	W02-51311	W02-71311

REAR RIM

	Bike	Year	14inch	16inch
H	CR80R/85R/R2	96-07	W02-23321	W02-43331
	CRF150R/R2	07-17	W02-23311	W02-43321
	CRF125F	14-17	-	W02-43411
	CRM50/80	93-97	W02-23321	-
Y	YZ80/85/LW	94-17	W02-23331	W02-43311
	TT-R125LW	00-11	-	W02-43411
K	KX80/85/II/100	98-17	W02-23211	W02-43211
	KLX125/150S	09-16	-	W02-43211
S	RM85/L	04-16	W02-23331	W02-43311

Z-WHEEL

S30 SPOKE SET



- Spoke sets for small mx racing bikes.
- Available steel replacement nipples.

S30 Spoke set (Front)

	Bike	Year	Spoke set	Steel nipple
H	CR80R2/85R2	96-07	W10-10023	W38-D236M
	CRF150R2	07-17	W10-10025	W38-D236M
Y	YZ80LW/85LW	94-17	W10-50014	W38-D236M
K	KX80II/85II/100	98-17	W10-30020	W38-F336M
	KLX125	10-16	W10-30020	W38-F336M
S	RM85L	04-16	W10-50014	W38-D236M

S30 Spoke set (Rear)

	Bike	Year	Spoke set	Steel nipple
H	CR80R2/85R2	96-07	W10-10024	W38-D236M
	CRF150R2	07-17	W10-10026	W38-D236M
Y	YZ80LW/85LW	94-17	W10-70014	W38-D236M
K	KX80II/85II/100	98-17	W10-30021	W38-F336M
S	RM85L	04-16	W10-50015	W38-D236M



S16 SERIES

Z-WHEEL

WHEEL/DISC

WHEEL



BRAKE DISC



BRAKE HOSE



STICKER



Front

Rear

Bike	Year	part #
HONDA		
CR125M	#1 73-78	W04-92458
CR125R	79	W04-A2498
	83	W04-92478
CR250M	73-74	W04-92458
CR250R	82-83	W04-92478
CR80R2F	85	W04-92478
XR200R(ME)	83-02	W04-92478
XR250(ME)	79-80	W04-A2498
MT125	74-76	W04-92458
MTX125R	83	W04-92478
TL125	#1 73-78	W04-92458
	81	W04-92458
XL125	#1 75-78	W04-92458
	83-84	W04-92478
XL125R(JD04)	83-84	W04-92478
MTX200R(MD)	83-84	W04-92478
XL200R(MD)	83-84	W04-92478
CT250S	81-83	W04-72468
MT250	74-76	W04-92498
TL250	#1 75-76	W04-92458
SL250	72-74	W04-92498
XL250S	79-82	W04-A2498
XL250R		
/Paris Dakar	82-83	W04-92478
/Decosta		
XR350R	83	W04-92478
XL400R	82	W04-92478
XL500S	79-80	W04-A2498
XR500(PE01)	79-80	W04-A2498
YAMAHA		
MX125	72-73	W04-92468
	74	W04-92458
YZ125	74-75	W04-92458
DT1MX	76-83	W04-92478
DT2MX	70-71	W04-92468
YZ250	74-83	W04-92478
MX250	73-74	W04-92478
	#2 74-75	W04-92468
	#2 76-77	W04-92468
	#2 83-84	W04-92478
DT125	#2 78-82	W04-92478
	75-78	W04-92458
DT125M	#2 82	W04-92478
TY125	77-83	W04-92478
XT125(17T)	#2 75-80	W04-92458
IT175	82-84	W04-92478
TY175	75-80	W04-92458
XT200	#2 68-71	W04-92468
DT1	72-73	W04-92468
DT250	74-76	W04-92468
DT250M	77-78	W04-92488
IT250	77-82	W04-92478
TY250	74-76	W04-92458
XT250	80-82	W04-92478
XT250T	83-84	W04-92478
RT1	70-71	W04-92468
RT360	72-73	W04-92468
DT360	73	W04-92468
DT400	74	W04-92468
XT400	75-76	W04-92468
TT500	82	W04-92478
XT500	76-81	W04-92478
XT500(USA)	76-80	W04-92488
	81	W04-92488
KAWASAKI		
KX250A	74	W04-92468
KE125	#2 76-82	W04-92478
KS125(125TR)	#2 74-75	W04-92478
KL250	#2 78-79	W04-92488
	#2 80-83	W04-92478
F9(350TR)	72-74	W04-92468
SUZUKI		
RM125	75-76	W04-92478
	79-80	W04-92458
	81-82	W04-92478
RM250	79-80	W04-92468
	81-82	W04-92478
	72-74	W04-92458
TM250	75	W04-92478
TM400	71-72	W04-92458
TS50	#2 83-97	W04-92478
TS125	#2 73-75	W04-92458
	#2 76-79	W04-92478
TS250	71-73	W04-92468
	74-76	W04-92468
TS400	72-73	W04-92468
	74-77	W04-92468
SP500	81-84	W04-92468

Bike	Year	part #
HONDA		
CR125R	79	W04-63478
CR250M	73-77	W04-64468
XR200R(ME)	81-83	W04-64458
XR250(ME)	79-80	W04-64458
TLM50	84	W04-64458
MT125	74-76	W04-64458
MTX125R	83	W04-64458
TL125/S	73-76	W04-64458
TL125	81	W04-64458
	83-88	W04-64458
XL125	75-78	W04-64458
	79-80	W04-64458
XL125S	81	W04-64458
XL125R(JD04)	85	W04-64458
MTX200R(MD)	83-84	W04-64458
MTX200R2(MD)	85-88	W04-64458
TLR200(MD)	83	W04-64458
XL200R(MD)	83-84	W04-64458
XL230	02-04	W04-64468
MT250	74-76	W04-64468
TL250	75-76	W04-64458
TLR250R(MD18)	86	W04-64458
SL250	72-74	W04-64468
	79-80	W04-64458
XL250S	81-82	W04-64468
XL250R		
/Paris Dakar	82-83	W04-54468
/Decosta		
XL400R	82	W04-54468
XL500S	79-80	W04-64468
XR500(PE01)	79-80	W04-64468
YAMAHA		
AT1M	#2 69-70	W04-63478
AT1MX	#2 71	W04-63478
MX125	72-74	W04-63478
YZ125	74-83	W04-63478
DT1MX	71	W04-64488
DT2MX	72	W04-64488
MX250	73-74	W04-64488
YZ250	74-79	W04-64488
DT125	#2 74-81	W04-63478
TY125	75-78	W04-64458
CT1	#2 69-71	W04-63478
CT175	#2 72-73	W04-63478
IT175	77-83	W04-63478
TY175	75-80	W04-64458
AG200	85	W04-64458
DT1	71	W04-64488
DT250	72-76	W04-64488
DT250M	77-78	W04-63478
IT250	77-80	W04-64488
TY250	75-76	W04-64458
XT250	80-82	W04-54468
DT360	73-74	W04-64488
RT1	70-71	W04-64488
RT360	72-73	W04-64488
DT400	75-76	W04-64488
TT500	76-81	W04-64488
XT500	76-80	W04-64468
XT500(USA)	81	W04-64468
KAWASAKI		
KL250	78-79	W04-64468
KL250	80-83	W04-54468
KLR250	84-90	W04-54468
F11(250TR)	74-76	W04-64488
SUZUKI		
RM125	78-80	W04-64458
TM250	72, 74	W04-64488
DR250S	82	W04-54468
	71-79	W04-64488
TS250	#2 80	W04-64488
	81-83	W04-64488
SP370	78	W04-64488
SP400	80	W04-64488
TS400	72-77	W04-64488

Z-WHEEL S16 RIM



- Aluminum rims for vintage off road bikes, make your vintage bike wheel look new.
- Available for many applications.
- Made of 7000 grade aluminium for durability and light weight.
- Silver anodized finish to match the vintage old style.
- Can be used with stock hubs, nipples and spokes.
- 1 X Rim lock hole on the rim.



*#1 and #2 models require to use with below Z wheel steel nipple sets.

#1 W38-D136M
#2 W38-D236M



ZIGRAM ROTOR

ジグラムローター

Bike	Year	Front		Rear	
		STD	STD	STD	MUD
HONDA					
CR125R	95-01	W51-10025	-	-	-
	02-07	W51-10025	W51-20026	W51-22026	-
CR250R	92-94	W51-10024	-	-	-
	95-01	W51-10025	-	-	-
CR500R	02-07	W51-10025	W51-20026	W51-22026	-
	92-94	W51-10024	-	-	-
CRF250R	04-14	W51-10025	W51-20026	W51-22026	-
	15-17	W51-10026	W51-20026	W51-22026	-
CRF450R	02-14	W51-10025	W51-20026	W51-22026	-
	15-17	W51-10026	W51-20026	W51-22026	-
CRF450RX	17	W51-10026	W51-20026	W51-22026	-
CRF250X	04-17	W51-10025	W51-20026	W51-22026	-
CRF450X	05-17	W51-10025	W51-20026	W51-22026	-
CRF150F/230F	03-09	W51-10024	-	-	-
SL230	97-01	W51-10024	W51-20033	-	-
XLR125R/200R	93-97	W51-10024	-	-	-
XLR250R/BAJA	89-90	W51-10024	-	-	-
XR230	91-94	W51-10024	W51-20033	-	-
	05-12	W51-10024	W51-20033	-	-
XR250/BAJA/MOTARD	95-07	W51-10024	W51-20033	-	-
XR250R	91-04	W51-10024	W51-20033	-	-
XR400R	96-04	W51-10024	W51-20033	-	-
XR600R	91-06	W51-10024	W51-20033	-	-
XR650R	00-11	W51-10024	-	-	-
CRM250R/AR	89-90	W51-10024	-	-	-
CRF250L	91-99	W51-20024	W51-20033	-	-
	12-16	W51-10035	W51-20033	-	-
CRF250M	13-16	-	W51-20033	-	-
YAMAHA					
YZ125/250	01	W51-10326	-	-	-
	02-16	W51-10326	W51-20326	W51-22326	-
	17	W51-10327	W51-20326	W51-22326	-
YZ250F	01	W51-10326	-	-	-
	02-15	W51-10326	W51-20326	W51-22326	-
YZ450F	16-17	W51-10327	W51-20326	W51-22326	-
	02	-	W51-20326	W51-22326	-
YZ125X	03-15	W51-10326	W51-20326	W51-22326	-
	16-17	W51-10327	W51-20326	W51-22326	-
YZ250X	17	W51-10327	W51-20326	W51-22326	-
	16	W51-10326	W51-20326	W51-22326	-
YZ250FX	17	W51-10327	W51-20326	W51-22326	-
	15-16	W51-10326	W51-20326	W51-22326	-
YZ450FX	17	W51-10327	W51-20326	W51-22326	-
	16-17	W51-10327	W51-20326	W51-22326	-
WR250F	02-15	W51-10326	W51-20326	W51-22326	-
	16-17	W51-10327	W51-20326	W51-22326	-
WR450F	02-15	W51-10326	W51-20326	W51-22326	-
	16	W51-10327	W51-20326	W51-22326	-
WR250R	07-17	W51-10335	W51-20335	-	-
WR250X	07-17	-	W51-20335	-	-
DT200WR	91-94	-	W51-20333	-	-
DT230LANZA	97-98	W51-10332	W51-20333	-	-
TTR250	93-97	W51-10332	W51-20333	-	-
TTR250RAID	94-96	W51-10332	W51-20333	-	-
TW225	02-07	W51-10333	-	-	-
SEROW225	85-04	W51-10333	W51-20336	-	-
SEROW250	05-16	W51-10336	W51-20336	-	-
XT250X	06-16	W51-10336	W51-20336	-	-
TRICKER	04-16	W51-10333	W51-20336	-	-
BRONCO	97-99	W51-10333	-	-	-
KAWASAKI					
KX125/250	03-05	-	W51-20125	W51-22125	-
	06-08	W51-10126	W51-20125	W51-22125	-
KX250F	04-05	-	W51-20125	W51-22125	-
	06-14	W51-10126	W51-20125	W51-22125	-
KX450F	15-17	W51-10127	W51-20125	W51-22125	-
	06-14	W51-10126	W51-20125	W51-22125	-
KLX450R	15-17	W51-10127	W51-20125	W51-22125	-
	08-15	W51-10126	W51-20125	W51-22125	-
KLX125,D-TRACKER125	10-16	W51-10151	W51-20151	-	-
KLX150S	09-13	W51-10151	W51-20151	-	-
	93-97	W51-10141	-	-	-
KLX250/SR/ES	98-07	W51-10141	W51-20140	-	-
	08-16	W51-10141	W51-20141	-	-
D-TRACKER	98-07	W51-10141	W51-20140	-	-
D-TRACKER X	08-16	-	W51-20141	-	-
KDX125SR	90-99	W51-10141	W51-20140	-	-
KDX200R	95-06	-	W51-20140	-	-
KDX200SR	90-93	W51-10141	W51-20140	-	-
KDX220R	94-05	W51-10141	W51-20140	-	-
KDX220SR	94-99	W51-10141	W51-20140	-	-
KDX250R/SR	91	W51-10141	W51-20140	-	-
	92-94	-	W51-20140	-	-
SUZUKI					
RM125	88	-	W51-20225	-	-
	89-98	W51-10326	W51-20225	-	-
	99-05	W51-10326	W51-20226	-	-
RM250	06-08	W51-10326	-	-	-
	87-88	-	W51-20225	-	-
	89-98	W51-10326	W51-20225	-	-
RMZ250	99-05	W51-10326	W51-20226	-	-
	06-08	W51-10326	-	-	-
	04-06	-	W51-20125	W51-22125	-
RMZ450	07-17	W51-10226	W51-20227	W51-22227	-
RMX250R	05-17	W51-10226	W51-20227	W51-22227	-
RMX250S	89-98	W51-10326	W51-20225	-	-
DRZ400S/R	92-98	W51-10326	W51-20225	-	-
DRZ400SM	00-09	W51-10326	W51-20225	-	-
DR250R	05-09	-	W51-20226	-	-
DJEBEL250/XC	95-00	W51-10326	-	-	-
250SB	96-00	W51-10326	-	-	-
KTM	02-06	W51-10141	W51-20140	-	-
	125-450SX/XC	98-17	W51-10525	W51-20525	W51-22525
125-530EXC/XC-W	98-17	W51-10525	W51-20525	W51-22525	
450SMR	04-14	-	W51-20525	W51-22525	
HUSQVARNA					
TC/FC/TX/FX125-450	14-16	W51-10525	W51-20525	W51-22525	
TE/FE125-501	14-16	W51-10525	W51-20525	W51-22525	
FS450	15-16	-	W51-20525	W51-22525	

Z-WHEEL ZIGRAM ROTOR

- Standard sized brake rotor developed for use under extreme conditions with off road riding.
- Thick design for improved strength.
- Made of high carbon stainless steel (SUS420) for better brake feel and corrosion resistance.
- Standard type is a light weight design with holes placed based on strength analysis.
- Mud type has a solid design to keep the mud away from the rotor and prevent frictional wear of brake pads in a muddy race.

STD ROTOR



MUD ROTOR

MUD SPECIAL

Reduce wear and tear on the brake pads.





Z-WHEEL
BRAKE HOSE

- PTFE inner brake hose covered stainless mesh provides better stopping power and sensitive control.
- PVC red and blue colored brake hose cover protects stainless mesh from rock and mud.
- Chrome plate coated brake banjo. Nut fitting design provides flexible brake hose installation.

Bike	Year	Front			Rear			
		C-Black	Blue	Red	C-Black	Blue	Red	
HONDA	CR125/250	02-07	W61-12011	W61-12012	W61-12013	W61-25051	W61-25052	W61-25053
	CRF250R	04-17	W61-12011	W61-12012	W61-12013	W61-25051	W61-25052	W61-25053
	CRF450R	02-16	W61-12011	W61-12012	W61-12013	W61-25051	W61-25052	W61-25053
	CRF250X	04-06	-	-	-	W61-25051	W61-25052	W61-25053
		07-17	W61-14011	-	W61-14013	W61-25051	W61-25052	W61-25053
		05-07	-	-	-	W61-25051	W61-25052	W61-25053
	CRF450X	08-17	W61-14011	-	W61-14013	W61-25051	W61-25052	W61-25053
	CRF250L	12-16	W61-14011	-	W61-14013	W61-25051	W61-25052	W61-25053
	CRF250M	13-16	W61-14511	-	W61-14513	W61-25051	W61-25052	W61-25053
		95-96	-	-	-	W61-25061	-	W61-25063
XR250	00-02	-	-	-	W61-25061	-	W61-25063	
	03-07	W61-13011	W61-13012	W61-13013	W61-25061	-	W61-25063	
	08-12	W61-10011	-	-	-	-	-	
XR230/M	08-12	W61-10011	-	-	-	-	-	
CRM250R/AR	91-98	W61-14021	W61-14022	-	-	-	-	
YAMAHA	YZ125/250	05-07	-	-	-	W61-25011	W61-25012	-
		08-17	W61-12011	W61-12012	W61-12013	W61-25011	W61-25012	-
	YZ250/450F	08-17	W61-12011	W61-12012	W61-12013	W61-25011	W61-25012	-
	YZ125X	17	W61-12011	W61-12012	W61-12013	W61-25011	W61-25012	-
	YZ250X	16-17	W61-12011	W61-12012	W61-12013	W61-25011	W61-25012	-
	YZ250FX	15-17	W61-12011	W61-12012	W61-12013	W61-25011	W61-25012	-
	YZ450FX	16-17	W61-12011	W61-12012	W61-12013	W61-25011	W61-25012	-
	WR250F	07-16	-	-	-	W61-25011	W61-25012	-
		07-11	-	-	-	W61-25011	W61-25012	-
	WR450F	16	-	-	-	W61-25011	W61-25012	-
	WR250R	08-17	W61-13011	W61-13012	W61-13013	W61-25011	W61-25012	-
	WR250X	08-17	W61-14021	W61-14022	-	W61-25011	W61-25012	-
	XG250	04-16	W61-10011	-	-	W61-25031	-	-
SEROW225/XT225	92-04	W61-10011	-	-	-	-	-	
SEROW250/XT250	05-16	W61-10011	-	-	W61-25031	-	-	
XT250X	06-16	W61-10011	-	-	W61-25031	-	-	
KAWASAKI	KX125/250	04-08	W61-12021	W61-12022	W61-12023	-	-	-
		04-05	W61-12021	W61-12022	W61-12023	-	-	-
	KX250F	06	-	-	-	W61-25021	W61-25022	W61-25023
		07-17	W61-12021	W61-12022	W61-12023	W61-25021	W61-25022	W61-25023
		07-09	W61-12021	W61-12022	W61-12023	W61-25021	W61-25022	W61-25023
		10-17	W61-12021	W61-12022	W61-12023	W61-25021	W61-25022	W61-25023
	KLX250	98-07	-	-	-	W61-25041	W61-25042	-
		08-16	W61-13021	W61-13022	-	W61-25041	W61-25042	-
KDX220SR	94-99	W61-14021	W61-14022	-	W61-25051	W61-25052	W61-25053	
KDX125SR	90-99	-	-	-	W61-25051	W61-25052	W61-25053	
D-Tracker/X	98-16	-	-	-	W61-25041	W61-25042	-	
KLX125	10-16	W61-13011	W61-13012	W61-13013	-	-	-	
SUZUKI	RM125/250	04-08	W61-12021	W61-12022	W61-12023	-	-	-
		04-06	W61-12021	W61-12022	W61-12023	-	-	-
	RMZ250	09-15	W61-12021	W61-12022	W61-12023	W61-25021	W61-25022	W61-25023
		16-17	W61-12021	W61-12022	W61-12023	-	-	-
		08-15	W61-12021	W61-12022	W61-12023	W61-25021	W61-25022	W61-25023
		16-17	W61-12021	W61-12022	W61-12023	-	-	-
	RMZ400S	00-08	W61-14021	W61-14022	-	W61-26011	-	-
	DRZ400E	00-07	-	-	-	W61-26011	-	-
DRZ400SM	05-08	W61-14011	-	W61-14013	W61-25061	-	W61-25063	
RMX250S	96-98	W61-14021	W61-14022	-	W61-26011	-	-	

WR250R WHEEL



Z-WHEEL
BRAKE ROTOR CARRIER

- Brake rotor mount kit designed for WR250R hubs.
- Allow your WR250R hub to use WR250X larger brake discs for more stopping power.
- Made of durable aluminum with black anodized finish.

W41-83110



Red

Z-WHEEL RIM STICKER KIT

21 inch / 17-19 inch

- Z-Wheel rim sticker kit.
- Available for 21 inch and 17-19 inch wheels. A sheet covers one wheel.
- Available in 5 different colors.

21inch

Part number	Color	Part number	Color
W50-1202	Blue	W50-1205	Yellow
W50-1203	Red	W50-1206	Orange
W50-1204	Green		



Blue



Green

17-19inch

Part number	Color	Part number	Color
W50-1302	Blue	W50-1305	Yellow
W50-1303	Red	W50-1306	Orange
W50-1304	Green		



Yellow



Orange

Z-WHEEL STICKER



LOGO (Swingarm)

Part number	Size
W50-0120	200 X 31 mm ("7.9 X "1.2)



LOGO

Part number	Size
W50-0110	100 X 16 mm ("3.9 X "0.6)



LOGO

Part number	Size
W50-0115	150 X 22 mm ("5.9 X "0.8)

CORP - LOGO

Part number	Size
W50-0211	110 X 38 mm ("4.3 X "1.5)



- High quality light weight titanium bolts, nuts, washers and pivot pins available from ZETA.
- Brake disc bolt kit and sprocket kit available for specific models.
- Made of hot forged Ti-6AL-4V for a durable and extremely light weight-product.
- High precision CNC machined bolt and nut head, head size is one size-smaller than industrial standard for reduced weight.

Hot forging, CNC machining, thread rolling

ZETA titanium product is designed to be light weight with no decoration. Titanium products are not only machined but also hot forged to provide more tensile strength than material strength. Bolt and nut are designed with a smaller CNC machined head for a lighter design.

Titanium type and strength difference between other material.

Pure Titanium	Lower price than other titanium alloy, great corrosion resistance, but less strength.
Alfa alloy	Great creep resistance and welding work, but bad workability.
Beta alloy	Most durable titanium alloy, easy workability, but high production cost.
Alfa beta alloy	Great durability, ductility, toughness and workability. Zeta Titanium product is made of this material, Ti-6AL-4V.

Ti-6AL-4V

ZETA titanium products are made of Ti-6AL-4V. This chemical notation means this titanium includes 6% aluminum (AL) and 4% vanadium (V). This material is light weight and durable. It is used in aircraft and space industries, nuclear industry, industrial turbine, race car and motorcycle etc.

Titanium Name	Alloy name	Tensile strength
Pure titanium	JIS Grade 1	275-412N / mm ²
Pure titanium	JIS Grade 2	343-510N / mm ²
Pure titanium	JIS Grade 3	481-618N / mm ²
Alfa alloy	Ti-5AL-2.5Sn	850N / mm ²
Alfa-beta alloy	Ti-6AL-4V	900-930N / mm²
Beta alloy	Ti-15Mo-5Zr-3Al	1470N / mm ²

Other alloy	Alloy name	Tensile strength
Duralumin	2017-T4	425N / mm ²
Super duralumin	2024-T361	495N / mm ²
Extra super duralumin	7075-T6	481-618N / mm ²
Steel	SS400	400N / mm ²
Carbon steel	S45C	570N / mm ²
Chromium molybdenum steel	SCM435	930N / mm ²



RACING FLANGE BOLT
M6 P=1.0 L 10 mm - 45 mm



CAP BOLT
M6 P=1.0 L 10 mm - 45 mm



RACING FLANGE BOLT
M10 P=1.25 L 20 mm - 75 mm
* Includes safety wire holes.



CAP BOLT
M8 P=1.25 L 16 mm - 55 mm

CAP BOLT TAPER
M5 P=0.8 L 15 mm

CAP BOLT LOW HEAD
M8 P=1.25 L 20 mm - 40 mm

ZETA
RACING FLANGE BOLT

- One size smaller bolt head design for light weight. Motorcycle use.
- Comes with wire holes for bolts larger than M7 sizes.
- Sold in single pieces.

Application P76

ZETA
CAP BOLT

- Cap bolt available in straight and tapered types.
- Bolt head is forged, CNC finish.
- Sold in single pieces.

Application P76

ZETA
FLAT HEAD BOLT

- Countersunk bolt. 1pc.

Application P76

ZETA
STD FLANGE BOLT

- Standard size flange bolt.
- Sold in single pieces.

Application P76



ZETA
EXHAUST NUT



- Titanium exhaust nut does not rust like OEM steel exhaust nuts.
- Flange design, can be tightend with 6mm wrench or hex wrench.

Application P76

ZETA
FLANGE NUT COMPACT



- Titanium compact head size nut.
- Attained one size smaller head design because of its durable and light weight Ti-6AL-4V material.
- Great to use in high tightening torque and high temperature situations.
- Sold in single pieces.

Application P76

ZETA
FLANGE LOCK NUT



- ZETA original locking function. No use locking plate or locking nylon used.
- Original locking function holds secure, but has less damage to the bolt than U lock nut.
- Sold in single pieces.

Application P76



ZETA
SPROCKET NUT SET



- Titanium sprocket flange lock nut set.
- One size smaller size nut head for reduced weight.
- Lighter than OEM sprocket nuts,
- Nut sizes available : M8, M10 and M12, comes in 5pc or 6pc sets.

Application P77

ZETA
SPROCKET BOLT & NUT SET



- Titanium sprocket bolt and nut set, lighter than OEM sprocket bolts and nuts.
- Rust and stain resistant due to passive film on titanium material.
- Sprocket bolt set and bolt & nut set available.

Application P77



ZETA

CHAIN ADJUSTER BOLT



- By using titanium bolts the unsprung weight is reduced, and compared to stock bolts, strength is increased and visual appeal is enhanced.
- Nut is designed one size smaller, for reduced weight and compactness. And because titanium bolts form a non-conductive coating on the surface, it will not rust.
- M8 is used by the four main Japanese manufacturers of off-road, and also some on-road manufacturers (Axle block bolt adjustment type vehicle).
- M10 is mainly used on KTM off-road models, and Husqvarna.

Application P76



KTM



YZF-R1

TITANIUM



ZETA

BANJO BOLT



- Titanium brake banjo bolts available for many sizes to fit most brake hoses.
- Light weight design, comes with wiring holes.
- 1.0 thread size banjo bolts for Brembo master cylinders and brake calipers.
- Sold in single pieces.

Application P76



ZETA

CALIPER MOUNT BOLT



- Light weight titanium caliper mount bolt kit for sport bikes.
- Bolt size is designed compact to reduce weight.
- Can be used for Brembo brake calipers.
- Wiring holes on the bolt to meet racing regulations.
- Comes with 2 bolts for rear brake calipers. 4 bolts for front radial brake calipers.

Application P76

ZETA

CALIPER BRIDGE BOLT



- Titanium caliper bridge bolt kit.
- Make your caliper weight lighter.
- Highly corrosion resistant, won't get rust like steel OE bolts.
- For Brembo 2 piece brake caliper use.
- Comes with 4 bolts.

Application P76





ZETA

PIVOT PIN



- Titanium Pivot pin for Brembo master cylinder.
- Stock pivot pin is made of steel, easily rusts, wears and can freeze.
- This titanium pivot pin does not rust and provides smooth lever movement.
- Gold anodized finish for exclusive look.

Part #	Type	Set
ZT15-3110	Brembo Racing	Washer & Snap Pin
ZT15-3110	Brembo Street	Washer & Snap Pin
ZT15-3120	Brembo RCS	-

ZETA

BLEEDER SCREW



- 10mm wrench size bleeder screw for Brembo master cylinder.
- Easy operation and lighter than stock 11mm wrench size bleeder.

Part #	Size	Type
ZT15-4100	M10 P=1.0	Brembo

ZETA

MASTER CYLINDER CLAMP BOLT SET



- Titanium bolt set for Brembo master cylinder clamp.
- Compatible with flange type and tapered cap type.
- Comes with 2 bolts.

Part#	Type
ZT82-1202	Brembo M6x20 Flange Bolt set
ZT82-1252	RCS M6x25 Flange Bolt Set
ZT88-1202	Brembo M6x20 Taper Bolt set
ZT88-1252	RCS M6x25 Taper Bolt Set

ZETA

BRAKE ADAPTER



- Titanium straight fitting brake hose adapter.
- Available 1.25 and 1.0 (Brembo) thread sizes.
- Sold in single pieces.

Part#	Size
ZT15-2000	M10 P=1.0
ZT15-2010	M10 P=1.25



ZETA

CYLINDER HEAD BOLT



- Side bolt for cylinder head to optimally dress up the engine.
- Oil line bolt for Kawasaki, engine plug for Suzuki oil cooling engine and Katana offered.
- Please use new O-ring and gasket for installation.

Part #	Size	Type
ZT15-5330	M14 P=1.5	Kawasaki Oil Line Bolt
ZT15-5530	M14x12 P=1.25	Suzuki Engine Plug



SUZUKI Engine Plug

KAWASAKI Oil Line Bolt

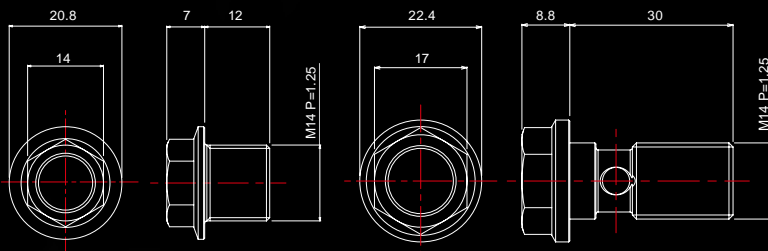

ZETA

WASHER



- Made of CNC machined Ti-6AL-4V
- Excellent accuracy, unlike common press machine punched washers.
- Reduce weight by replacing with titanium washers, as well as increasing strength, improved visual appeal.
- Lineup for the high frequency of use M6, M8 and M10.

Part #	Size	Inner diameter	Outer diameter	thickness
ZT20-1061	M6	6.4	12	1.6
ZT20-1081	M8	8.4	16	1.6
ZT20-1101	M10	10.4	20	2.1

SIGNIFICANT LIGHT WEIGHT TITANIUM AXLE SHAFT



LIGHT WEIGHT

The specific gravity of Ti-6AL-4V is about 4.4. This is about 56 % with respect to the specific gravity of 7.8 of stock axle shaft using iron(SS400) and carbon steel (S45C), or chromium molybdenum steel shaft (SCM440). This means that if you manufacture the axle shaft in the same mass, 64 titanium will be able to produce about 44 % reduction. The reduced weight of the axle shaft also reduces the unsprung weight and corner approaches will improve the handling and stability. In addition, the reduction of unsprung weight will not only improve the movement of the suspension, but also improve brake performance.

ULTRA STRENGTH

Strength of Ti-6AL-4V is comparable to chromium molybdenum steel (SCM435) 900 - 930 Mpa. With the higher strength axle shaft, you will be able to feel more road surface information more directly. You will be able to sense the bumpy road that could not be felt until now.

BENDING

The Young's modulus of Ti-6AL-4V is about half of iron and chromium molybdenum steel at 106 Gpa. The Young's modulus represents the rigidity and elasticity, the higher the number, the higher the high rigidity. Generally, one thinks "high-strength = high rigidity," also 64 titanium has been taken for granted as high rigidity, but actually it is only half the rigidity of iron. Therefore it easily deformed, but there is elastic deformation where a material tries to return to its original state and plastic deformation where deformation is permanent. 64 titanium has a wide range of elastic deformation. In other words this is "BENDING". It is this bending that produces the suspension effect, and high strength that softly transmits road surface information.

Not only Light. Not only strong. Not only flexible. If it is made of aluminum or magnesium it will be lighter than 64 titanium but it will lack strength. If it is made of chromium-molybdenum steel and nickel-chromium steel it will be stronger than 64 titanium, but it will be heavy. There is also materials having Young's modulus lower than 64 titanium, but it will not mean that there is "BENDING." 64 titanium is superior to a balance of these materials. Therefore it may be said that it is the best material for the axle shaft.

Also we must not forget the appearance of titanium. It more difficult to rust than stock shaft and chromium-molybdenum steel shaft that has a protective surface treatment. However, it does not escape corrosion where the surface is compromised for some reason. Ti-6AL-4V forms a passive film surface to prevent semi-permanent rust to form.

Material	Material symbol and heat treatment	Tensile strength (T/Mpa)	Young's modulus (E/Gpa)	Specific gravity
Rolled steel for general structure	SS400(Annealing)	450	206	7.87
Carbon steel for mechanical structure	S45C(Normalizing)	570 or more	205	7.83
Chromium-molybdenum steel	SCM440(Tempering quenching)	980 or more	206	7.86
Austenitic stainless steel	SUS304(Solution treatment)	520 or more	197	7.93
Pure aluminum	A1085 P(Annealing)	55	69	2.70
Duralumin (aluminum alloy)	A2017 P(Natural aging)	355	69	2.79
Ultra duralumin (aluminum alloy)	A2024 P(Natural aging)	430	74	2.78
Extra Ultra duralumin (aluminum alloy)	A7075 P(quench-and-temper)	573	72	2.81
Pure titanium (JIS grade1)	TF270	275-412	106	4.51
Pure titanium (JIS grade 2)	TF340	343-510	106	4.51
Pure titanium (JIS grade 3)	TF480	481-618	106	4.51
Titanium (α alloy)	Ti-5AL-2.5Sn	850	118	4.48
Titanium (α-β alloy)	Ti-6AL-4V	900-930	106	4.43
Titanium (β alloy)	Ti-15Mo-5Zr-3AL	1470	75-95	4.80

OFFROAD

Please check race regulation when use for race

STREET

Bike	Year	Front	Rear
CRF250R	04-17		
CRF450R	02-17		
CRF450RX	17	ZT60-1164	ZT60-1264 #1
CR125R	04-07		
CR250R	04-07		
CRF150R/B	07-17	ZT60-1161	ZT60-1261
CRF250L/M	12-15	ZT60-1173	ZT60-1273
YZ250F	14-17		
YZ450F	14-17	ZT60-4165	ZT60-4265
YZ250FX	15-17		
YZ450FX	16-17		
WR250R/X	07-17	ZT60-4173	ZT60-4273
KX250F	04-17		
KX450F	06-17		
KLX450R	08-15	ZT60-2164	ZT60-2264 #2
KX125	04-08		
KX250	04-08		
KLX250R/SR	93-97		
KLX300R	96-07		
KDX200	95-99	ZT60-2172	ZT60-2272 #3-1
KDX220R/SR	94-05		
KLX650R	93-96		
KLX250/D-Tracker	98-06		
KLX250/D-Tracker	07	ZT60-2173	
KLX250/D-TrackerX	08-16		ZT60-2273

Bike	Year	Front	Rear
RMZ250	04-06		
RMZ450	07-17	ZT60-2164	ZT60-2264
RMX450Z	10-		
DRZ400S	00-16		ZT60-2272 #3-2
DRZ400/E	00-17	ZT60-3173	ZT60-3273 #3-2
DRZ400SM	05-17		ZT60-5264 #4
TC125/250	16-17		ZT60-5263 #4
FC250/450	15-17	ZT60-5164	ZT60-5264 #4
FC350	16-17		ZT60-5263 #4
TX300	17	ZT60-5164	ZT60-5263 #4
FX350/450	17		
TE125/250/300	16-17		
FE250/350/450/501	16-17		
TE150	17		
TX125	17		

Bike	Year	Front	Rear
CBR1000RR	08-16	ZT61-1101	ZT61-1201 #5
CB1300SF/SB	14-16	ZT61-1102	ZT61-1202 #5
YZF-R1/M	15-16	ZT61-4101	ZT61-4201 #5
MT-09	14-16	ZT61-4102	ZT61-4202 #5
Ninja ZX-10R	16	ZT61-2101	ZT61-2201 #5
Ninja ZX-14R	06-16	ZT61-2102	ZT61-2202 #5
Ninja H2/R	15-16	ZT61-2103	-
GSX1300R	08-16	ZT61-3101	ZT61-3201 #5
GSX-R1000	17	ZT61-3102	ZT61-3202 #5
SI1000RR	15-16	ZT61-6101	ZT61-6201 #5
1199/S/R,1299/S	12-16	ZT61-7101	-
MONSTER1200/S/R	14-16	ZT61-7102	-

- #1 ZETA axle block (ZE93-5013) or CRF 09' UP L side stock axle block (42305-KRN-A30) need to be replaced CR/CRF '08.
- #2 ZETA axle block (ZE93-514X) or KX450F 16' UP or L and R side stock axle block (33040-0050 / 33040-0080) need to be replaced KX/KX250F '16, KX450F '15'. Recommend to replace to KAWASAKI stock lock nut (92210-0939) for model with cotter pin in castle nut.
- #3-1 KAWASAKI stock snail cam (33040-1113) needs to be required for shaft and snail cam welded models.
- #3-2 SUZUKI stock snail cam (61410-29F00), YAMAHA stock M20 lock nut (90185-20002), M20 washer (90201-20020) need separately.
- #4 Requires to take stock L side axle block off. Please use strong locktite when mounting.
- #5 Comes with titanium nut and safety clip.



Thin Head



Pan Head



Countersunk



Flat Head



Flange Bolt

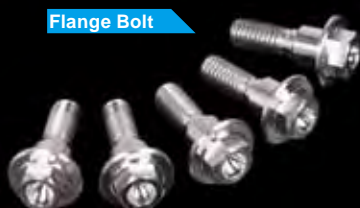

ZETA
BRAKE DISC BOLT



- Titanium brake disc bolts kit.
- Different bolt head design from OE bolts for better workability.
- Available as a kit for specific models.
- Available for sport bikes and off road bikes applications.

Street Application P78

Off Application P79



ZETA
MASTER CYLINDER BOLT KIT



- The Kit includes clamp bolt, pivot pin, breeder screw etc for bremsbo master cylinder and RCS master cylinder.
- Compatible with flange and taper cap type.

Application P75



TITANIUM





ZETA
HANDLEBAR CLAMP BOLT KIT



ZETA
UPPER STEM FORK CLAMP BOLT KIT



ZETA
UNDER STEM FORK CLAMP BOLT KIT



ZETA
FRONT AXLE PINCH BOLT KIT

OFF ROAD TITANIUM BOLT KIT

Kit package includes the required number to suit each motorcycle

Application P75



ZETA
FRONT CALIPER MOUNT BOLT KIT

OFF ROAD TITANIUM BOLT KIT Application



Bike	Year	Handle Bar Clamp Bolt	Upper Stem Fork Cramp	Under Stem Fork Clamp	Front Axle Pinch Bolt	Caliper Mount Bolt Kit		
HONDA	CR85R/R2	03-07	ZT83-2304	ZT83-2352	ZT83-2404	-	ZT83-2302	
	CRF150R/B	07-17	ZT83-2304	ZT83-2352	ZT83-2404	-	ZT83-2302	
	CR125R/250R	02-07	ZT83-2354	ZT83-2454	ZT83-2454	ZT83-2404	ZT83-2402	
	CRF250R	04-17	ZT83-2354	ZT83-2454	ZT83-2454	ZT83-2404	ZT83-2402	
	CRF450R	02-17	ZT83-2354	ZT83-2454	ZT83-2454	ZT83-2404	ZT83-2402	
	CRF450R X	17	ZT83-2354	ZT83-2454	ZT83-2454	ZT83-2404	ZT83-2402	
	CRF250X	04-17	ZT83-2354	ZT83-2454	ZT83-2454	ZT83-2404	ZT83-2402	
	CRF450X	05-16	ZT83-2354	ZT83-2454	ZT83-2454	ZT83-2404	ZT83-2402	
	CRF250L/M	12-16	ZT83-2354	ZT83-2454	ZT83-2454	ZT83-2402	ZT83-2302	
	CRM250R/AR	94-98	ZT83-2354	ZT83-2454	ZT83-2404	ZT83-2404	ZT83-2402	
	XR230/Motard	05-13	ZT83-2354	ZT83-2454	ZT83-2354	-	ZT83-2402	
XR250/Motard	03-07	ZT83-2354	ZT83-2504	ZT83-2404	ZT83-2402	ZT83-2402		
YAMAHA	YZ85/LW	02-14	ZT83-2304	ZT83-2352	ZT83-2404	-	ZT83-2352	
		15-17	ZT83-2304	ZT83-2402	ZT83-2404	-	ZT83-2352	
		95-06	ZT83-2354	ZT83-2404	ZT83-2404	ZT83-2404	ZT83-2352	
	YZ125/250		07	ZT83-2404	ZT83-2404	ZT83-2404	ZT83-2404	ZT83-2352
			08-14	ZT83-2404	ZT83-2404	ZT83-2404	ZT83-2354	ZT83-2352
			15-17	ZT83-2404	ZT83-2404	ZT83-2404	ZT83-2354	ZT83-2352
	YZ250F		01-05	ZT83-2354	ZT83-2404	ZT83-2404	ZT83-2404	ZT83-2352
			06	ZT83-2354	ZT83-2354	ZT83-2404	ZT83-2404	ZT83-2352
			07-17	ZT83-2354	ZT83-2354	ZT83-2354	ZT83-2354	ZT83-2352
	YZ400F	98-99	ZT83-2354	ZT83-2404	ZT83-2404	ZT83-2404	ZT83-2352	
	YZ426F	00-02	ZT83-2354	ZT83-2404	ZT83-2404	ZT83-2404	ZT83-2352	
	YZ450F		03-05	ZT83-2354	ZT83-2404	ZT83-2404	ZT83-2404	ZT83-2352
			06	ZT83-2354	ZT83-2354	ZT83-2404	ZT83-2404	ZT83-2352
			07	ZT83-2354	ZT83-2354	ZT83-2354	ZT83-2404	ZT83-2352
		08-17	ZT83-2354	ZT83-2354	ZT83-2354	ZT83-2354	ZT83-2352	
	YZ125X	17	ZT83-2404	ZT83-2404	ZT83-2354	ZT83-2354	ZT83-2352	
	YZ250X	16-17	ZT83-2404	ZT83-2404	ZT83-2354	ZT83-2354	ZT83-2352	
	YZ250FX	15-17	ZT83-2354	ZT83-2354	ZT83-2354	ZT83-2354	ZT83-2352	
	YZ450FX	16-17	ZT83-2354	ZT83-2354	ZT83-2354	ZT83-2354	ZT83-2352	
	WR250F	01-06	ZT83-2354	ZT83-2404	ZT83-2404	ZT83-2404	ZT83-2352	
		07-15	ZT83-2354	ZT83-2354	ZT83-2404	ZT83-2404	ZT83-2352	
WR400F	98-00	ZT83-2354	ZT83-2404	ZT83-2404	ZT83-2404	ZT83-2352		
WR426F	01-02	ZT83-2354	ZT83-2404	ZT83-2404	ZT83-2404	ZT83-2352		
WR450F	03-06	ZT83-2354	ZT83-2404	ZT83-2404	ZT83-2404	ZT83-2352		
	07-15	ZT83-2354	ZT83-2354	ZT83-2404	ZT83-2404	ZT83-2352		
WR250R/X	07-17	ZT83-2354	ZT83-2404	ZT83-2404	ZT83-2404	ZT83-2352		
SEROW250	05-16	ZT87-1304	ZT83-2404	ZT83-2354	-	ZT84-2302		
KAWASAKI	KX85/2	01-13	ZT83-2304	ZT83-2352	ZT83-2404	-	ZT83-2402	
		14-17	ZT83-2354	ZT83-2352	ZT83-2404	-	ZT83-2402	
	KX100	16-17	ZT83-2354	ZT83-2352	ZT83-2404	-	ZT83-2402	
	KX125	03-05	ZT83-2304	ZT83-2354	ZT83-2404	ZT83-2404	ZT83-2402	
		06-08	ZT83-2354	ZT83-2404	ZT83-2404	ZT83-2404	ZT83-2402	
	KX250		03-04	ZT83-2304	ZT83-2354	ZT83-2404	ZT83-2404	ZT83-2402
			05	ZT83-2304	ZT83-2404	ZT83-2404	ZT83-2404	ZT83-2402
			06-08	ZT83-2354	ZT83-2404	ZT83-2404	ZT83-2404	ZT83-2402
	KX250F	04-05	ZT83-2304	ZT83-2354	ZT83-2404	ZT83-2404	ZT83-2402	
		06-17	ZT83-2354	ZT83-2404	ZT83-2454	ZT83-2404	ZT83-2402	
	KX450F	06-14	ZT83-2354	ZT83-2404	ZT83-2404	ZT83-2404	ZT83-2402	
	15-17	ZT83-2354	ZT83-2404	ZT83-2454	ZT83-2404	ZT83-2402		
KLX125	10-16	ZT83-2304	ZT83-2352	ZT84-2352	-	ZT84-2402		
D-Tracker125	10-15	ZT83-2304	ZT83-2352	ZT83-2354	-	ZT84-2402		
KLX250/D-Tracker	98-07	ZT83-2304	ZT83-2404	ZT84-2402	-	ZT83-2402		
KLX250/D-TrackerX	08-16	ZT83-2304	ZT83-2404	ZT84-2402	ZT83-2404	ZT83-2402		
SUZUKI	RM85/L	02-04	ZT83-2354	ZT83-2404	ZT83-2404	-	-	
		05-12	ZT83-2354	ZT83-2404	ZT83-2404	-	ZT83-2302	
		01	ZT83-2404	ZT83-2404	ZT83-2404	ZT83-2404	ZT83-2402	
	RM125	02-08	ZT83-2354	ZT83-2404	ZT83-2404	ZT83-2404	ZT83-2402	
	RM250	01-08	ZT83-2354	ZT83-2404	ZT83-2404	ZT83-2404	ZT83-2402	
	RMZ250		04-06	ZT83-2304	ZT83-2354	ZT83-2404	ZT83-2404	ZT83-2402
			07-15	ZT83-2354	ZT83-2404	ZT83-2404	ZT83-2404	ZT83-2402
			16-17	ZT83-2354	ZT83-2454	ZT83-2454	ZT83-2404	ZT83-2402
	RMZ450	05-17	ZT83-2354	ZT83-2404	ZT83-2404	ZT83-2404	ZT83-2402	
	DRZ400S	00-17	ZT83-2354	ZT83-2504	ZT83-2454	ZT83-2354	ZT83-2402	
	DRZ400SM		05-06	ZT83-2354	ZT83-2404	ZT83-2404	ZT83-2404	ZT83-2402
		07-17	ZT83-2404	ZT83-2404	ZT83-2404	ZT83-2404	ZT83-2402	

Part #	Type	Size	qty
ZT83-2302	Flange Bolt Set *	M8X30	2
ZT83-2304	Flange Bolt Set *	M8X30	4
ZT83-2352	Flange Bolt Set *	M8X35	2
ZT83-2354	Flange Bolt Set *	M8X35	4
ZT83-2402	Flange Bolt Set *	M8X40	2
ZT83-2404	Flange Bolt Set *	M8X40	4
ZT83-2454	Flange Bolt Set *	M8X45	4
ZT83-2504	Flange Bolt Set *	M8X50	4
ZT84-2302	Flange Bolt Set *	M10x30	2
ZT84-2352	Flange Bolt Set *	M10x35	2
ZT84-2402	Flange Bolt Set *	M10x40	2
ZT87-1304	Cap Bolt Set	M8X30	4

No wiring hole

[Caution] This compatibility table is only for OEM applications. Do not use this table if non OEM parts are used.

MASTER CYLINDER BOLT KIT Application



Part #	Type	Part #	qty	Description
ZT32-1110	Brembo Master Cylinder Flange Bolt Kit	ZT99-9001	1	Flange Bolt M6x19
		ZT03-0620	2	Flange Bolt M6x20
		ZT15-3110	1	Pivot Pin
		ZT15-4100	1	Washer M6
		ZT15-4100	1	Bleeder Screw M10 P=1.0
ZT32-1120	Brembo Master Cylinder Taper Cap Bolt Kit	ZT08-0620	3	Taper Cap Bolt M6x20
		ZT15-3110	1	Pivot Pin
		ZT15-4100	1	Washer M6
ZT32-1210	RCS Master Cylinder Flange Bolt Kit	ZT03-0625	3	Flange Bolt M6x25
		ZT21-2061	1	Flange Nut Compact M6
		ZT15-3120	1	Pivot Pin
ZT32-1220	RCS Master Cylinder Taper Cap Bolt Kit	ZT15-4100	1	Bleeder Screw M10 P=1.0
		ZT08-0625	3	Taper Cap Bolt M6x25
		ZT21-2061	1	Flange Nut Compact M6
		ZT15-3120	1	Pivot Pin
		ZT15-4100	1	Bleeder Screw M10 P=1.0

RACING FLANGE BOLT

P68

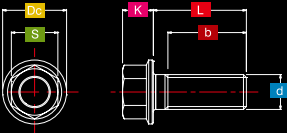

Part#	d	S	Dc	K	b	L
ZT03-0610	M6 P=1.0	8	11	5.3	8	10
ZT03-0616	M6 P=1.0	8	11	5.3	14	16
ZT03-0620	M6 P=1.0	8	11	5.3	18	20
ZT03-0625	M6 P=1.0	8	11	5.3	18	25
ZT03-0630	M6 P=1.0	8	11	5.3	18	30
ZT03-0635	M6 P=1.0	8	11	5.3	18	35
ZT03-0640	M6 P=1.0	8	11	5.3	18	40
ZT03-0645	M6 P=1.0	8	11	5.3	18	45
ZT03-0650	M6 P=1.0	8	11	5.3	18	50
ZT03-0655	M6 P=1.0	8	11	5.3	18	55
ZT03-0660	M6 P=1.0	8	11	5.3	18	60
ZT03-0665	M6 P=1.0	8	11	5.3	18	65
ZT03-0670	M6 P=1.0	8	11	5.3	18	70
ZT03-0675	M6 P=1.0	8	11	5.3	18	75
ZT03-0680	M6 P=1.0	8	11	5.3	18	80
ZT03-0816	M8 P=1.25	10	14	6.8	14	16
ZT03-0820	M8 P=1.25	10	14	6.8	18	20
ZT03-0825	M8 P=1.25	10	14	6.8	22	25
ZT03-0830	M8 P=1.25	10	14	6.8	22	30
ZT03-0835	M8 P=1.25	10	14	6.8	22	35
ZT03-0840	M8 P=1.25	10	14	6.8	22	40
ZT03-0845	M8 P=1.25	10	14	6.8	22	45
ZT03-0850	M8 P=1.25	10	14	6.8	22	50
ZT03-0855	M8 P=1.25	10	14	6.8	22	55
ZT03-0860	M8 P=1.25	10	14	6.8	22	60
ZT03-1030	M10 P=1.25	12	17	8.2	26	30
ZT03-1035	M10 P=1.25	12	17	8.2	26	35
ZT03-1040	M10 P=1.25	12	17	8.2	26	40

Part#	d	S	Dc	K	b	L
ZT04-0720	M7 P=1.0	10	14	6.8	18	20
ZT04-0816	M8 P=1.25	10	14	6.8	14	16
ZT04-0820	M8 P=1.25	10	14	6.8	18	20
ZT04-0825	M8 P=1.25	10	14	6.8	22	25
ZT04-0830	M8 P=1.25	10	14	6.8	22	30
ZT04-0835	M8 P=1.25	10	14	6.8	22	35
ZT04-0840	M8 P=1.25	10	14	6.8	22	40
ZT04-0845	M8 P=1.25	10	14	6.8	22	45
ZT04-0850	M8 P=1.25	10	14	6.8	22	50
ZT04-0855	M8 P=1.25	10	14	6.8	22	55
ZT04-1020	M10 P=1.25	12	17	8.2	18	20
ZT04-1025	M10 P=1.25	12	17	8.2	23	25
ZT04-1030	M10 P=1.25	12	17	8.2	26	30
ZT04-1035	M10 P=1.25	12	17	8.2	26	35
ZT04-1040	M10 P=1.25	12	17	8.2	26	40
ZT04-1045	M10 P=1.25	12	17	8.2	26	45
ZT04-1050	M10 P=1.25	12	17	8.2	26	50
ZT04-1055	M10 P=1.25	12	17	8.2	26	55
ZT04-1060	M10 P=1.25	12	17	8.2	26	60
ZT04-1065	M10 P=1.25	12	17	8.2	26	65
ZT04-1070	M10 P=1.25	12	17	8.2	26	70
ZT04-1075	M10 P=1.25	12	17	8.2	26	75
ZT04-1120	M10 P=1.5	12	17	8.2	18	20
ZT04-1125	M10 P=1.5	12	17	8.2	23	25
ZT04-1130	M10 P=1.5	12	17	8.2	26	30

* Includes safety wire holes.

CHAIN ADJUSTER BOLT

P70



Part#	d	S	K	L	Description	qty
ZT38-5500	M8 P=1.25	10	5.5	50	Chain Adjuster bolt	1
ZT38-5501	M8 P=1.25	10	5.5	50	Chain Adjuster bolt & Nut	2 set
ZT38-7500	M10 P=1.25	10	5.5	50	Chain Adjuster bolt	1
ZT38-7501	M10 P=1.25	10	5.5	50	Chain Adjuster bolt & Nut	2 set

BANJO BOLT

P70

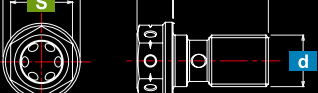

Part#	d	S	Dc	K	L	Type
ZT15-1000	M10 P=1.0	12	15	7	20.5	Z-WHEEL, EARLS
ZT15-1010	M10 P=1.0	12	15	7	18.5	GOODRIDGE
ZT15-1020	M10 P=1.25	12	15	7	22.0	Universal

CALIPER MOUNT BOLT

P70

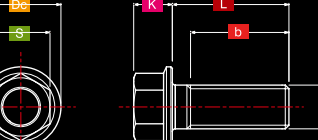

Part#	d	S	Dc	K	b	L	qty	Type
ZT33-1072	M7 P=1.0	10	14	6.8	18	20	2	brebm Rear Caliper, Racing
ZT33-1082	M8 P=1.25	10	14	6.8	18	20	2	brebm Rear Caliper, Street
ZT33-1504	M10 P=1.25	12	17	8.2	26	50	4	Radial Mout Caliper
ZT33-1554	M10 P=1.25	12	17	8.2	26	55	4	Radial Mout Caliper
ZT33-1604	M10 P=1.25	12	17	8.2	26	60	4	Radial Mout Caliper
ZT33-1654	M10 P=1.25	12	17	8.2	26	65	4	Radial Mout Caliper
ZT33-1704	M10 P=1.25	12	17	8.2	26	70	4	Radial Mout Caliper
ZT33-1754	M10 P=1.25	12	17	8.2	26	75	4	Radial Mout Caliper

CAP BOLT

P68

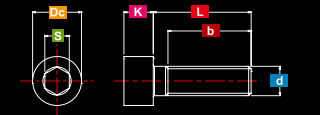

Cap Screw Straight (mm)

Part No.	d	S	Dc	K	b	L
ZT07-0610	M6 P=1.0	5	10	6	8	10
ZT07-0615	M6 P=1.0	5	10	6	13	15
ZT07-0616	M6 P=1.0	5	10	6	14	16
ZT07-0620	M6 P=1.0	5	10	6	18	20
ZT07-0625	M6 P=1.0	5	10	6	23	25
ZT07-0630	M6 P=1.0	5	10	6	24	30
ZT07-0635	M6 P=1.0	5	10	6	24	35
ZT07-0640	M6 P=1.0	5	10	6	24	40
ZT07-0645	M6 P=1.0	5	10	6	24	45
ZT07-0816	M8 P=1.25	6	13	8	14	16
ZT07-0820	M8 P=1.25	6	13	8	18	20
ZT07-0825	M8 P=1.25	6	13	8	23	25
ZT07-0830	M8 P=1.25	6	13	8	28	30
ZT07-0835	M8 P=1.25	6	13	8	28	35
ZT07-0840	M8 P=1.25	6	13	8	28	40
ZT07-0845	M8 P=1.25	6	13	8	28	45
ZT07-0850	M8 P=1.25	6	13	8	28	50
ZT07-0855	M8 P=1.25	6	13	8	28	55
ZT07-1020	M10 P=1.25	8	16	10	18	20
ZT07-1025	M10 P=1.25	8	16	10	23	25
ZT07-1030	M10 P=1.25	8	16	10	28	30
ZT07-1035	M10 P=1.25	8	16	10	32	35
ZT07-1040	M10 P=1.25	8	16	10	32	40
ZT07-1045	M10 P=1.25	8	16	10	32	45
ZT07-1120	M10 P=1.5	8	16	10	18	20
ZT07-1125	M10 P=1.5	8	16	10	23	25
ZT07-1130	M10 P=1.5	8	16	10	28	30

Cap Screw Low Head (mm)

Part No.	d	S	Dc	K	b	L
ZT07-2620	M6 P=1.0	5	10	4	18	20
ZT07-2625	M6 P=1.0	5	10	4	18	25
ZT07-2820	M8 P=1.25	6	13	5	18	20
ZT07-2825	M8 P=1.25	6	13	5	22	25
ZT07-2830	M8 P=1.25	6	13	5	22	30
ZT07-2835	M8 P=1.25	6	13	5	22	35
ZT07-2840	M8 P=1.25	6	13	5	22	40

Cap Screw Taper (mm)

Part No.	d	S	Dc	K	b	L
ZT08-0516	M5 P=0.8	4	8.5	5	15	16
ZT08-0616	M6 P=1.0	5	10	6	14	16
ZT08-0620	M6 P=1.0	5	10	6	18	20
ZT08-0625	M6 P=1.0	5	10	6	18	25

STD FLANGE BOLT

P68

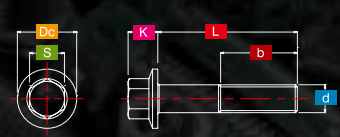

Part No.	d	S	Dc	K	b	L
ZT01-0835	M8 P=1.25	10	17	8.5	22	35
ZT01-0840	M8 P=1.25	10	17	8.5	22	40
ZT01-0845	M8 P=1.25	10	17	8.5	22	45
ZT01-0850	M8 P=1.25	10	17	8.5	22	50

FLAT HEAD BOLT

P68

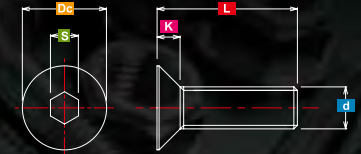

Part No.	d	S	Dc	K	L
ZT09-6121	M6 P=1.0	4	12	3.3	12
ZT09-6161	M6 P=1.0	4	12	3.3	16
ZT09-6201	M6 P=1.0	4	12	3.3	20

CALIPER BRIDGE BOLT

P70

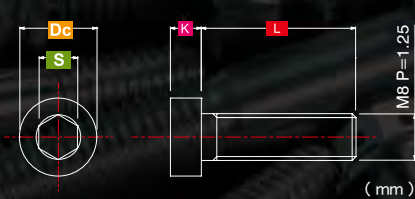

Caliper Bridge Bolt (mm)

Part No.	d	S	Dc	K	L	qty
ZT07-2835	M8 P=1.25	6	13	5	35	1
ZT37-3064	M8 P=1.25	6	13	5	35	4
ZT07-2840	M8 P=1.25	6	13	5	40	1
ZT37-3084	M8 P=1.25	6	13	5	40	4

FLANGE LOCK NUT

P69

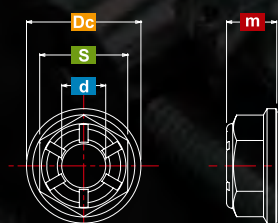

Part No.	d	S	Dc	m
ZT21-1061	M6 P=1.0	10	13	5.7
ZT21-1081	M8 P=1.25	12	16	7.6
ZT21-1101	M10 P=1.25	14	19	9.6
ZT21-1121	M12 P=1.25	17	23	11.6

FLANGE NUT COMPACT

P69

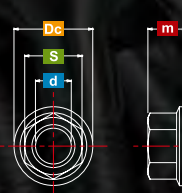

Part No.	d	S	Dc	m
ZT21-2061	M6 P=1.0	8	11	5.4
ZT21-2081	M8 P=1.25	10	14	6.8
ZT21-2101	M10 P=1.25	12	17	8.2

EXHAUST NUT

P69

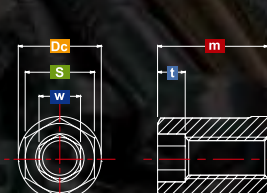

Part No.	d	S	Dc	w	m	t	qty
ZT23-1061	M6 P=1.0	10	12	6	16	4	1
ZT36-1068	M6 P=1.0	10	12	6	16	4	8
ZT23-1081	M8 P=1.25	12	14	8	18	4.5	1
ZT36-1088	M8 P=1.25	12	14	8	18	4.5	8



SPROCKET NUT SET

SPROCKET BOLT & NUT SET

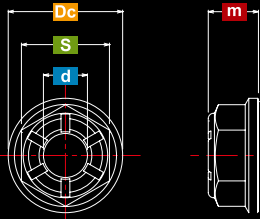

Part No.	d	S	Dc	m	qty
ZT35-0806	M8 P=1.25	12	16	7.6	6
ZT35-1005	M10 P=1.25	14	19	9.6	5
ZT35-1006	M10 P=1.25	14	19	9.6	6
ZT35-1205	M12 P=1.25	17	23	11.6	5

COUNTERSUNK Dimensions

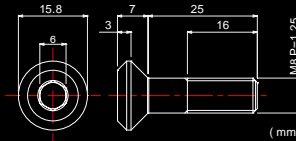

PAN HEAD Dimensions

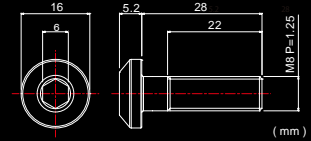

Part #	d	Dc	K	b	L	qty	Bolt Type	Description
ZT11-0825	M8 P=1.25	15.8	7	16	25	1	Counter Sunk	Sprocket Bolt
ZT34-2504N	-	-	-	-	-	4	Counter Sunk	Sprocket Bolt & Nut
ZT34-2506N	-	-	-	-	-	6	Counter Sunk	Sprocket Bolt & Nut
ZT11-1828	M8 P=1.25	16	5.2	22	28	1	Pan Head	Sprocket Bolt
ZT34-2706N	-	-	-	-	-	6	Pan Head	Sprocket Bolt & Nut

TITANIUM



SPROCKET BOLT & NUT 6 set

Bike	Year	Part#
HONDA		
CRF250R	04-17	ZT34-2506N
CRF450R	02-17	ZT34-2506N
CRF450RX	17	ZT34-2506N
CRF250X	04-17	ZT34-2506N
CRF450X	05-16	ZT34-2506N
CR125R/250R	92-07	ZT34-2506N
CRF150F/230F	03-11	ZT34-2506N
XR250R	96-04	ZT34-2506N
XR400R	96-06	ZT34-2506N
XR650R	00-07	ZT34-2506N
CRM250AR	97-98	ZT34-2506N
SL230	97-04	ZT34-2506N
XR230	05-13	ZT34-2506N
XR250	95-07	ZT34-2506N
XR250 Baja	95-04	ZT34-2506N
XR230 Motard	08-13	ZT34-2506N
XR250 Motard	03-07	ZT34-2506N
YAMAHA		
YZ125/250	90-17	ZT34-2506N
YZ250F	01-17	ZT34-2506N
YZ400F	98-99	ZT34-2506N
YZ426F	00-02	ZT34-2506N
YZ450F	03-17	ZT34-2506N
YZ125X	17	ZT34-2506N
YZ250X	16-17	ZT34-2506N
YZ250FX	15-17	ZT34-2506N
YZ450FX	16-17	ZT34-2506N
WR250F	01-15	ZT34-2506N
WR400F	98-00	ZT34-2506N
WR426F	01-02	ZT34-2506N
WR450F	03-15	ZT34-2506N
WR250R/X	07-17	ZT34-2706N
KAWASAKI		
KX250F	04-17	ZT34-2506N
KX450F	06-17	ZT34-2506N
KLX250/D-Tracker	98-07	ZT34-2506N
KLX250/D-TrackerX	08-16	ZT34-2506N
KLX250ES	94-97	ZT34-2506N
KLX250SR	93-97	ZT34-2506N
KLX300R	96-07	ZT34-2506N
KLX450R	08-09	ZT34-2506N
KLX650R	93-96	ZT34-2506N
KX125/250	89-08	ZT34-2506N
KDX125SR	90-99	ZT34-2506N
KDX200SR	90-93	ZT34-2506N
KDX220SR	94-99	ZT34-2506N
KDX250SR	91-94	ZT34-2506N
KDX220R	94-05	ZT34-2506N
KDX250R	91-95	ZT34-2506N
SUZUKI		
RMZ250	07-17	ZT34-2506N
RMZ450	05-17	ZT34-2506N
RMX450Z	10-14	ZT34-2506N
RM125	88-08	ZT34-2506N
RM250	88-08	ZT34-2506N
DRZ400	00-04	ZT34-2506N
DRZ400E	00-17	ZT34-2506N
DRZ400S	00-16	ZT34-2506N
DRZ400SM	05-17	ZT34-2506N
RMX250R	89-98	ZT34-2506N
RMX250S	92-98	ZT34-2506N
RH250	84-88	ZT34-2506N
TS125R	89-97	ZT34-2506N
TS200R	89-96	ZT34-2506N
Djebel250XC / DR250R X	95-05	ZT34-2506N
DR250S	90-94	ZT34-2506N
DR250R	95-00	ZT34-2506N
DR350S	90-93	ZT34-2506N
DR650SE	96-00	ZT34-2506N
DR800S	91-96	ZT34-2506N

SPROCKET BOLT & NUT 6 set

Bike	Year	Part#
KTM		
125SX	01-17	ZT34-2506N
150SX	09-17	ZT34-2506N
250SX	01-17	ZT34-2506N
250SX-F	05-17	ZT34-2506N
350SX-F	11-17	ZT34-2506N
450SX-F	07-17	ZT34-2506N
450SX-R	03-06	ZT34-2506N
450SMR	05-14	ZT34-2506N
125EXC	03-14	ZT34-2506N
150XC	12-14	ZT34-2506N
200EXC	00-17	ZT34-2506N
250EXC	00-17	ZT34-2506N
300EXC	00-17	ZT34-2506N
300XC-W	12-14	ZT34-2506N
250EXC-R	01-06	ZT34-2506N
250EXC-F	07-17	ZT34-2506N
350EXC-F	12-17	ZT34-2506N
400EXC-R	00-05	ZT34-2506N
450EXC-R	03-08	ZT34-2506N
525EXC-R	03-07	ZT34-2506N
400EXC	09-11	ZT34-2506N
450EXC/F	09-17	ZT34-2506N
500EXC/F	12-17	ZT34-2506N
530EXC	09-11	ZT34-2506N
690ENDURO/R	08-14	ZT34-2506N
690SMC/R	08-14	ZT34-2506N

SPROCKET BOLT & NUT 4 set

Bike	Year	Part#
HONDA		
CRF150R/B	07-14	ZT34-2504N
CR80R/R2	96-02	ZT34-2504N
CR85R/R2	03-07	ZT34-2504N
CRM50	94-98	ZT34-2504N
CRM80	94-98	ZT34-2504N
CRF50F	04-14	ZT34-2504N
CRF70F	04-12	ZT34-2504N
CRF80F	04-12	ZT34-2504N
CRF100F	04-12	ZT34-2504N
CRF125F	14-15	ZT34-2504N
XR50R	00-03	ZT34-2504N
XR70R	97-03	ZT34-2504N
XR80R	85-03	ZT34-2504N
XR100R	90-03	ZT34-2504N
TLM220R	90-93	ZT34-2504N
YAMAHA		
YZ80/LW	93-01	ZT34-2504N
YZ85/LW	02-17	ZT34-2504N
SUZUKI		
DRZ125/L	03-09	ZT34-2504N
RM80	94-01	ZT34-2504N
RM85/L	02-12	ZT34-2504N
KTM		
85SX	03-17	ZT34-2504N
FREERIDE 250R	14-17	ZT34-2504N
FREERIDE 350	12-17	ZT34-2504N

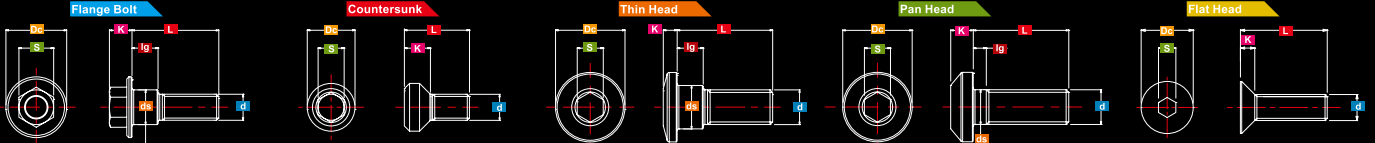

Type	Part#	d	S	Dc	K	ds	lg	L	qty
Thin Head 8mm-M6x15	ZT10-3141	M6 P=1.0	5	14	3	8	23	15	1
	ZT31-3144	M6 P=1.0	5	14	3	8	23	15	4
	ZT31-3146	M6 P=1.0	5	14	3	8	23	15	6
Thin Head 9mm-M6x14	ZT10-3421	M6 P=1.0	5	13	2.8	9	2.5	14	1
	ZT31-3424	M6 P=1.0	5	13	2.8	9	2.5	14	4
	ZT31-3426	M6 P=1.0	5	13	2.8	9	2.5	14	6
Thin Head 10mm-M8x14.5	ZT10-3721	M8 P=1.25	6	14.8	3.2	10	2.5	14.5	1
	ZT31-3724	M8 P=1.25	6	14.8	3.2	10	2.5	14.5	4
	ZT31-3726	M8 P=1.25	6	14.8	3.2	10	2.5	14.5	6
Thin Head 10mm-M8x20	ZT10-3741	M8 P=1.25	6	16	3.2	10	4.5	20	1
	ZT31-3743	M8 P=1.25	6	16	3.2	10	4.5	20	3
	ZT31-3744	M8 P=1.25	6	16	3.2	10	4.5	20	4
Thin Head 10mm-M8x22	ZT10-3761	M8 P=1.25	6	16	3.2	10	6	22	1
	ZT31-3763	M8 P=1.25	6	16	3.2	10	6	22	3
	ZT31-3764	M8 P=1.25	6	16	3.2	10	6	22	4
Thin Head 10mm-M8x28	ZT10-3781	M8 P=1.25	6	16	3.2	10	9	28	1
	ZT31-3783	M8 P=1.25	6	16	3.2	10	9	28	5
	ZT31-3786	M8 P=1.25	6	16	3.2	10	9	28	6
Pan Head 8mm-M8x16	ZT10-1651	M8 P=1.25	6	16	5.2	-	3	22	1
	ZT31-1653	M8 P=1.25	6	16	5.2	-	3	22	5
	ZT31-1656	M8 P=1.25	6	16	5.2	-	3	22	6
Flange Bolt 6mm-M6x12.5	ZT10-0521	M6 P=1.0	8	14	5.3	-	2.5	12.5	1
	ZT31-0526	M6 P=1.0	8	14	5.3	-	2.5	12.5	6
	ZT10-0231	M6 P=1.0	8	10.5	5.3	-	2	13	1
Flange Bolt 6mm-M6x13	ZT31-0234	M6 P=1.0	8	10.5	5.3	-	2	13	4
	ZT31-0236	M6 P=1.0	8	10.5	5.3	-	2	13	6

With nut

Type	Part#	d	S	Dc	K	ds	lg	L	qty
Flange Bolt 6mm-M6x16	ZT10-0261	M6 P=1.0	8	10.5	5.3	-	2	16	1
	ZT31-0263	M6 P=1.0	8	10.5	5.3	-	2	16	3
	ZT31-0264	M6 P=1.0	8	10.5	5.3	-	2	16	4
	ZT31-0265	M6 P=1.0	8	10.5	5.3	-	2	16	5
	ZT31-0266	M6 P=1.0	8	10.5	5.3	-	2	16	6
Flange Bolt 6mm-M6x15	ZT03-0615	M6 P=1.0	8	11	5.3	-	2	15	1
	ZT31-5706	M6 P=1.0	8	11	5.3	-	2	15	6
	ZT10-0551	M6 P=1.0	8	13	5.2	-	3	17	1
Flange Bolt 6mm-M6x17	ZT31-0554	M6 P=1.0	8	13	5.2	-	3	17	4
	ZT31-0555	M6 P=1.0	8	13	5.2	-	3	17	5
	ZT31-0556	M6 P=1.0	8	13	5.2	-	3	17	6
Flange Bolt 6mm-M6x20	ZT03-0620	M6 P=1.0	8	11	5.3	-	2	20	1
	ZT31-5614	M6 P=1.0	8	11	5.3	-	2	20	4
	ZT31-5616	M6 P=1.0	8	11	5.3	-	2	20	6
Flange Bolt&Nut 6-M6x20	ZT31-5614N #	M6 P=1.0	8	11	5.3	-	2	20	4
	ZT31-5616N #	M6 P=1.0	8	11	5.3	-	2	20	6
Flange Bolt 8mm-M8x20	ZT03-0820	M8 P=1.25	10	14	6.8	-	2.5	20	1
	ZT31-4824	M8 P=1.25	10	14	6.8	-	2.5	20	4
	ZT31-4826	M8 P=1.25	10	14	6.8	-	2.5	20	6
Flange Bolt 8mm-M6x20	ZT10-0781	M6 P=1.0	8	14	5.2	8	6	20	1
	ZT31-0785	M6 P=1.0	8	14	5.2	8	6	20	5
	ZT31-0786	M6 P=1.0	8	14	5.2	8	6	20	6
Flange Bolt 8mm-M8x20	ZT10-0801	M8 P=1.25	10	13.7	6.5	-	3	20	1
	ZT31-3825	M8 P=1.25	10	13.7	6.5	-	3	20	5
	ZT31-3826	M8 P=1.25	10	13.7	6.5	-	3	20	6
Flange Bolt 10mm-M8x22	ZT10-0822	M8 P=1.25	10	15.8	5.8	10	6	22	1
	ZT31-0814	M8 P=1.25	10	15.8	5.8	10	6	22	4
	ZT31-0815	M8 P=1.25	10	15.8	5.8	10	6	22	5
Flange Bolt 10mm-M8x28	ZT31-0816	M8 P=1.25	10	15.8	5.8	10	6	22	6
	ZT10-0828	M8 P=1.25	10	15.8	5.8	10	9	28	1
	ZT31-0835	M8 P=1.25	10	15.8	5.8	10	9	28	5
Counter Sunk M6x14	ZT10-2631	M6 P=1.0	6	11	5	-	-	14	1
	ZT31-2634	M6 P=1.0	6	11	5	-	-	14	4
	ZT31-2636	M6 P=1.0	6	11	5	-	-	14	6
Counter Sunk M6x18	ZT10-2651	M6 P=1.0	6	11	6	-	-	18	1
	ZT31-2653	M6 P=1.0	6	11	6	-	-	18	3
	ZT31-2654	M6 P=1.0	6	11	6	-	-	18	4
Flat Head M6x12	ZT31-2656	M6 P=1.0	6	11	6	-	-	18	6
	ZT09-6121	M6 P=1.0	4	12	3.3	-	-	12	1
	ZT31-6124	M6 P=1.0	4	12	3.3	-	-	12	4
Flat Head M6x16	ZT09-6161	M6 P=1.0	4	12	3.3	-	-	16	1
	ZT31-6163	M6 P=1.0	4	12	3.3	-	-	16	3
	ZT31-6166	M6 P=1.0	4	12	3.3	-	-	16	6
Flat Head M6x20	ZT09-6201	M6 P=1.0	4	12	3.3	-	-	20	1
	ZT31-6203	M6 P=1.0	4	12	3.3	-	-	20	3



STREET DISC BOLT SET

Bike	Year	Front			Rear					
		Size	Qty	Part#	Size	Qty	Part#			
HONDA	CB1300SF / Bold'or	14-16	Flange Bolt	6mm-M6x17	5	ZT31-0555	Thin Head	10mm-M8x22	6	ZT31-3766
	X-4	05-13	Flange Bolt	6mm-M6x17	6	ZT31-0556	Thin Head	10mm-M8x22	6	ZT31-3766
	VFR1200F	07-03	Flange Bolt	6mm-M6x17	6	ZT31-0556	Thin Head	10mm-M8x22	6	ZT31-3766
	CB1100	10-16	Flange Bolt	6mm-M6x17	5	ZT31-0556	Thin Head	10mm-M8x20	5	ZT31-3745
	CBR1100XX	10-16	Flange Bolt	6mm-M6x17	5	ZT31-0555	Thin Head	10mm-M8x22	5	ZT31-3765
	CBR1000RR	04-06	Flange Bolt	6mm-M6x17	6	ZT31-0556	Thin Head	10mm-M8x22	6	ZT31-3766
	VTR1000F	07-06	Flange Bolt	6mm-M6x17	6	ZT31-0556	Thin Head	10mm-M8x22	4	ZT31-3764
	CBR954RR	02-03	Flange Bolt	6mm-M6x17	6	ZT31-0556	Thin Head	10mm-M8x22	4	ZT31-3764
	CBR929RR	00-01	Flange Bolt	6mm-M6x17	6	ZT31-0556	Thin Head	10mm-M8x22	4	ZT31-3764
	CB900F Hornet	02-07	Flange Bolt	6mm-M6x17	6	ZT31-0556	Thin Head	10mm-M8x22	4	ZT31-3764
	NC750S / X	14-16	Thin Head	10mm-M8x22	5	ZT31-3765	Thin Head	10mm-M8x22	5	ZT31-3765
	NC700S / X	12-16	Thin Head	10mm-M8x22	5	ZT31-3765	Thin Head	10mm-M8x22	5	ZT31-3765
	CBR600RR	03-16	Flange Bolt	6mm-M6x17	6	ZT31-0556	Thin Head	10mm-M8x22	4	ZT31-3764
YAMAHA	XJR1300	03-16	Flange Bolt	8mm-M6x20	6	ZT31-0786	Pan Head	8mm-M8x22	6	ZT31-1656
	XJR1200	98-02	Flange Bolt	8mm-M8x20	6	ZT31-4826	Pan Head	8mm-M8x22	6	ZT31-1656
	FZ1-S FAZER	96-97	Flange Bolt	8mm-M8x20	6	ZT31-4826	Pan Head	8mm-M8x22	6	ZT31-1656
	FZ1-N	08-14	Flange Bolt	8mm-M6x20	5	ZT31-0785	Thin Head	10mm-M8x20	5	ZT31-3745
	YZF-R1	08-12	Flange Bolt	8mm-M6x20	5	ZT31-0785	Thin Head	10mm-M8x20	5	ZT31-3745
	YZF-R1/M	04-14	Flange Bolt	8mm-M6x20	5	ZT31-0785	Thin Head	10mm-M8x20	5	ZT31-3745
	TDM900	15-16	Flange Bolt	8mm-M6x20	5	ZT31-0785	Thin Head	10mm-M8x20	5	ZT31-3745
	MT-09	02-12	Flange Bolt	8mm-M6x20	6	ZT31-0786	Pan Head	8mm-M8x22	6	ZT31-1656
	FZ8 / FAZER8	15-16	Flange Bolt	8mm-M6x20	5	ZT31-0785	Thin Head	10mm-M8x20	5	ZT31-3745
	MT-07	15-16	Flange Bolt	8mm-M6x20	5	ZT31-0785	Thin Head	10mm-M8x20	5	ZT31-3745
	YZF-R6	06-16	Flange Bolt	8mm-M6x20	5	ZT31-0785	Thin Head	10mm-M8x20	5	ZT31-3745
	XJ6 Diversion F	03-04	Flange Bolt	8mm-M6x20	6	ZT31-0786	Thin Head	10mm-M8x20	5	ZT31-3745
	XJ6	09-16	Flange Bolt	8mm-M6x20	6	ZT31-0786	Pan Head	8mm-M8x22	5	ZT31-1655
KAWASAKI	1400GTR	08-16	Thin Head	10mm-M8x22	5	ZT31-3765	Thin Head	10mm-M8x22	4	ZT31-3764
	ZZR1400	06-16	Thin Head	10mm-M8x22	5	ZT31-3765	Thin Head	10mm-M8x22	4	ZT31-3764
	ZZR1200	02-05	Thin Head	10mm-M8x22	5	ZT31-3765	Thin Head	10mm-M8x22	5	ZT31-3765
	ZX-12R	00-06	Thin Head	10mm-M8x22	5	ZT31-3765	Thin Head	10mm-M8x22	4	ZT31-3764
	ZRX1200 DAEG	09-16	Thin Head	10mm-M8x22	5	ZT31-3765	Thin Head	10mm-M8x22	4	ZT31-3764
	ZRX1200	01-07	Thin Head	10mm-M8x22	5	ZT31-3765	Thin Head	10mm-M8x22	5	ZT31-3765
	ZRX1100	96-00	Thin Head	10mm-M8x22	5	ZT31-3765	Thin Head	10mm-M8x22	5	ZT31-3765
	ZZR1100D	93-00	Thin Head	10mm-M8x22	5	ZT31-3765	Thin Head	10mm-M8x22	4	ZT31-3764
	ZEPHYR1100	92-06	Thin Head	10mm-M8x22	5	ZT31-3765	Thin Head	10mm-M8x22	6	ZT31-3766
	ZX-10R	04-16	Thin Head	10mm-M8x22	5	ZT31-3765	Thin Head	10mm-M8x22	4	ZT31-3764
	NINJA1000	11-16	Thin Head	10mm-M8x22	5	ZT31-3765	Thin Head	10mm-M8x22	4	ZT31-3764
	Z1000	03-16	Thin Head	10mm-M8x22	5	ZT31-3765	Thin Head	10mm-M8x22	4	ZT31-3764
	Versys1000	15-16	Thin Head	10mm-M8x22	5	ZT31-3765	Thin Head	10mm-M8x22	4	ZT31-3764
GPZ900R	93-99	Thin Head	10mm-M8x22	5	ZT31-3765	Thin Head	10mm-M8x22	6	ZT31-3766	
SUZUKI	GSX1300	01-06	Thin Head	10mm-M8x28	5	ZT31-3785	Thin Head	10mm-M8x28	5	ZT31-3785
	GSX1400R Hayabusa	08-16	Thin Head	10mm-M8x22	5	ZT31-0835	Thin Head	10mm-M8x22	6	ZT31-3766
	GSX1300 B-KING	99-07	Thin Head	10mm-M8x22	5	ZT31-3765	Thin Head			



OFF ROAD DISC BOLT SET



Rear DISC BOLT (KX450F)
Thin Head 10mm-M8 x 14.5 **ZT31-3724**



Front DISC BOLT (YZ250FX)
Counter Sunk M6 x 14 **ZT31-2636**

Bike	Year	Front				Rear			
		Size	Qty	Part No.	Size	Qty	Part No.		
CR80R/85R R2	96-07	Flange Bolt	6mm-M6x17	4	ZT31-0554	Flange Bolt	6mm-M6x17	4	ZT31-0554
CR125R/250R	95-01	Flange Bolt	6mm-M6x20 & Nut	6	ZT31-5616N #2	Thin Head	10mm-M8x22	4	ZT31-3764
CRF150R RB	07-17	Flange Bolt	6mm-M6x20 & Nut	4	ZT31-5616N #2	Flange Bolt	6mm-M6x20 & Nut	4	ZT31-5616N #2
CRF250R	04-17	Flange Bolt	6mm-M6x20 & Nut	6	ZT31-5616N #2	Flange Bolt	6mm-M6x20 & Nut	4	ZT31-5616N #2
CRF450R	02-17	Flange Bolt	6mm-M6x20 & Nut	6	ZT31-5616N #2	Flange Bolt	6mm-M6x20 & Nut	4	ZT31-5616N #2
CRF450RX	17	Flange Bolt	6mm-M6x20 & Nut	6	ZT31-5616N #2	Flange Bolt	6mm-M6x20 & Nut	4	ZT31-5616N #2
CRF250X	04-17	Flange Bolt	6mm-M6x20 & Nut	6	ZT31-5616N #2	Flange Bolt	6mm-M6x20 & Nut	4	ZT31-5616N #2
CRF450X	05-16	Flange Bolt	6mm-M6x20 & Nut	6	ZT31-5616N #2	Flange Bolt	6mm-M6x20 & Nut	4	ZT31-5616N #2
CRF125F	14-17	Flange Bolt	6mm-M6x17	4	ZT31-0554	-	-	-	-
CRF150F/230F	03-11	Flange Bolt	6mm-M6x17	4	ZT31-0554	-	-	-	-
CRF250L/M	12-16	Flange Bolt	6mm-M6x17	6	ZT31-0556	Thin Head	10mm-M8x22	4	ZT31-3764
CRM50/80	94-98	Flange Bolt	6mm-M6x17	4	ZT31-0554	Thin Head	10mm-M8x22	4	ZT31-3764
CRM250R/AR	89-98	Flange Bolt	6mm-M6x17	4	ZT31-0554	Thin Head	10mm-M8x22	4	ZT31-3764
SL230	97-04	Flange Bolt	6mm-M6x17	4	ZT31-0554	Thin Head	10mm-M8x22	4	ZT31-3764
XLR250R/BaJa	88-94	Flange Bolt	6mm-M6x17	4	ZT31-0554	Thin Head	10mm-M8x22	4	ZT31-3764
XR50/100 Motard	05-08	Thin Head	10mm-M8x22	3	ZT31-3763	Thin Head	10mm-M8x22	3	ZT31-3763
XR230/Motard	05-13	Flange Bolt	6mm-M6x17	4	ZT31-0554	Thin Head	10mm-M8x22	4	ZT31-3764
XR250/Baja	95-07	Flange Bolt	6mm-M6x17	4	ZT31-0554	Thin Head	10mm-M8x22	4	ZT31-3764
XR250 Motard	03-07	Flange Bolt	6mm-M6x17	4	ZT31-0554	Thin Head	10mm-M8x22	4	ZT31-3764
XR400 Motard	05-08	Flange Bolt	6mm-M6x17	4	ZT31-0554	Thin Head	10mm-M8x22	4	ZT31-3764
XR250R	90-04	Flange Bolt	6mm-M6x17	4	ZT31-0554	Thin Head	10mm-M8x22	4	ZT31-3764
XR400R	96-06	Flange Bolt	6mm-M6x17	4	ZT31-0554	Thin Head	10mm-M8x22	4	ZT31-3764
XR600R	91-00	Flange Bolt	6mm-M6x17	4	ZT31-0554	Thin Head	10mm-M8x22	4	ZT31-3764
XR650R	90-07	Flange Bolt	6mm-M6x17	4	ZT31-0554	Flange Bolt	6mm-M6x17	4	ZT31-0554
XR650L	93-15	Thin Head	10mm-M8x22	4	ZT31-3764	Thin Head	10mm-M8x22	4	ZT31-3764
XR750 AfricaTwin	93-05	Thin Head	10mm-M8x22	4	ZT31-3764 #1	Thin Head	10mm-M8x22	4	ZT31-3764
CRF1000L AfricaTwin	16	Flange Bolt	6mm-M6x17	6	ZT31-0556 #1	Thin Head	10mm-M8x22	4	ZT31-3764
YZ80.85/LW	93-17	Counter Sunk	M6x18	3	ZT31-2653	Counter Sunk	M6x18	4	ZT31-2654
	90-97	Counter Sunk	M6x18	6	ZT31-2656	Counter Sunk	M6x18	6	ZT31-2656
YZ125/250	98-07	Counter Sunk	M6x18	6	ZT31-2656	Flange Bolt	6mm-M6x12.5	6	ZT31-0526
	08-17	Counter Sunk	M6x14	6	ZT31-2636	Flange Bolt	6mm-M6x12.5	6	ZT31-0526
YZ250F	01-07	Counter Sunk	M6x18	6	ZT31-2656	Flange Bolt	6mm-M6x12.5	6	ZT31-0526
YZ250F/450F	08-17	Counter Sunk	M6x14	6	ZT31-2636	Flange Bolt	6mm-M6x12.5	6	ZT31-0526
YZ400F/426F/450F	99-07	Counter Sunk	M6x18	6	ZT31-2656	Flange Bolt	6mm-M6x12.5	6	ZT31-0526
YZ125X	17	Counter Sunk	M6x14	6	ZT31-2636	Flange Bolt	6mm-M6x12.5	6	ZT31-0526
YZ250X	16-17	Counter Sunk	M6x14	6	ZT31-2636	Flange Bolt	6mm-M6x12.5	6	ZT31-0526
YZ250FX	15-17	Counter Sunk	M6x14	6	ZT31-2636	Flange Bolt	6mm-M6x12.5	6	ZT31-0526
YZ450FX	16-17	Counter Sunk	M6x14	6	ZT31-2636	Flange Bolt	6mm-M6x12.5	6	ZT31-0526
WR250F	01-07	Counter Sunk	M6x18	6	ZT31-2656	Flange Bolt	6mm-M6x12.5	6	ZT31-0526
WR250/450F	08-15	Counter Sunk	M6x14	6	ZT31-2636	Flange Bolt	6mm-M6x12.5	6	ZT31-0526
WR400/426/450F	99-07	Counter Sunk	M6x18	6	ZT31-2656	Flange Bolt	6mm-M6x12.5	6	ZT31-0526
TTR125LW/LWE	00-06	Thin Head	8mm-M6x15	4	ZT31-3144	-	-	-	-
TTR200WR	01-09	Thin Head	8mm-M6x15	6	ZT31-3146	Thin Head	8mm-M6x15	6	ZT31-3146
DT230LANZA	97-00	Thin Head	8mm-M6x15	6	ZT31-3146	Thin Head	8mm-M6x15	6	ZT31-3146
TTR250R/RAID	93-97	Thin Head	8mm-M6x15	6	ZT31-3146	Thin Head	8mm-M6x15	6	ZT31-3146
TTR225/230	99-11	Flange Bolt	6mm-M6x17	6	ZT31-0556	-	-	-	-
SEROW225W/WE	93-04	Flange Bolt	6mm-M6x17	6	ZT31-0556	Thin Head	10mm-M8x20	3	ZT31-3743
SEROW250	05-16	Flange Bolt	6mm-M6x17	6	ZT31-0556	Thin Head	10mm-M8x20	3	ZT31-3743
TRICKER	04-16	Flange Bolt	6mm-M6x17	6	ZT31-0556	Thin Head	10mm-M8x20	3	ZT31-3743
WR250R	07-17	Flange Bolt	6mm-M6x15	6	ZT31-5706	Flange Bolt	6mm-M6x15	6	ZT31-5706
WR250X	07-17	PanHead Bolt	M8x16	6	ZT31-1626	Flange Bolt	6mm-M6x15	6	ZT31-5706
XT250X	06-16	Flange Bolt	6mm-M6x17	6	ZT31-0556	Thin Head	10mm-M8x20	3	ZT31-3743
XT600E	90-95	Flange Bolt	6mm-M6x15	6	ZT31-5706	Flange Bolt	6mm-M6x17	6	ZT31-0556
KX65	00-17	Thin Head	9mm-M6x14	4	ZT31-3424	Thin Head	9mm-M6x14	4	ZT31-3424
KX80/2	87-00	Flat Head Bolt	M6x12	4	ZT31-6124	Flat Head Bolt	M6x12	4	ZT31-6124
KX85/2	01-17	Thin Head	9mm-M6x14	6	ZT31-3426	Thin Head	9mm-M6x14	4	ZT31-3424
KX100	16-17	Thin Head	9mm-M6x14	6	ZT31-3426	Thin Head	9mm-M6x14	4	ZT31-3424
KX125/250	89-02	Counter Sunk	M6x14	4	ZT31-2634	Counter Sunk	M6x14	6	ZT31-2636
KX250F	03-08	Thin Head	9mm-M6x14	4	ZT31-3424	Thin Head	10mm-M8x14.5	4	ZT31-3724
KX450F	04-17	Thin Head	9mm-M6x14	4	ZT31-3424	Thin Head	10mm-M8x14.5	4	ZT31-3724
KLX450R	08-15	Thin Head	9mm-M6x14	4	ZT31-3424	Thin Head	10mm-M8x14.5	4	ZT31-3724
KLX125	10-16	Thin Head	10mm-M8x14.5	6	ZT31-3726	Thin Head	10mm-M8x14.5	6	ZT31-3726
D-TRACKER125	10-14	Thin Head	10mm-M8x14.5	6	ZT31-3726	Thin Head	10mm-M8x14.5	6	ZT31-3726
D-TRACKER/X	98-16	Thin Head	10mm-M8x14.5	4	ZT31-3724	Thin Head	10mm-M8x14.5	6	ZT31-3726
KLX250	98-16	Thin Head	10mm-M8x14.5	4	ZT31-3724	Thin Head	10mm-M8x14.5	6	ZT31-3726
KLX250ES	94-97	Thin Head	10mm-M8x14.5	4	ZT31-3724	Thin Head	10mm-M8x14.5	6	ZT31-3726
KLX250SR	93-97	Thin Head	10mm-M8x14.5	4	ZT31-3724	Thin Head	10mm-M8x14.5	6	ZT31-3726
KLX250R/300R	93-07	Counter Sunk	M6x14	4	ZT31-2634	Thin Head	10mm-M8x14.5	6	ZT31-3726
KLX650	93-96	Thin Head	10mm-M8x14.5	4	ZT31-3724	Thin Head	10mm-M8x14.5	6	ZT31-3726
KLX650R	93-96	Counter Sunk	M6x14	4	ZT31-2634	Thin Head	10mm-M8x14.5	6	ZT31-3726
KDX125SR	90-99	Thin Head	10mm-M8x14.5	4	ZT31-3724	Thin Head	10mm-M8x14.5	6	ZT31-3726
KDX200SR	90-93	Thin Head	10mm-M8x14.5	4	ZT31-3724	Thin Head	10mm-M8x14.5	6	ZT31-3726
KDX220R	94-99	Thin Head	10mm-M8x14.5	4	ZT31-3724	Thin Head	10mm-M8x14.5	6	ZT31-3726
KDX250R/SR	94-05	Thin Head	10mm-M8x14.5	4	ZT31-3724	Thin Head	10mm-M8x14.5	6	ZT31-3726
	91	Thin Head	10mm-M8x14.5	4	ZT31-3724	Thin Head	10mm-M8x14.5	6	ZT31-3726
	92-95	Counter Sunk	M6x14	4	ZT31-2634	Thin Head	10mm-M8x14.5	6	ZT31-3726
SUPER SHERPA	97-08	Thin Head	10mm-M8x14.5	6	ZT31-3726	-	-	-	-
RM80.85/L	94-12	Flat Head Bolt	M6x20	3	ZT31-6203 #3	Flat Head Bolt	M6x12	4	ZT31-6124
	88-95	Flat Head Bolt	M6x16	6	ZT31-6166	Flat Head Bolt	M6x16	6	ZT31-6166
RM125/250	96-05	Counter Sunk	M6x18	6	ZT31-2656	Counter Sunk	M6x18	6	ZT31-2656
	06-08	Counter Sunk	M6x18	6	ZT31-2656	Flange Bolt	6mm-M6x13	6	ZT31-0236
RMZ250	07-17	Thin Head	9mm-M6x14	4	ZT31-3424	Thin Head	10mm-M8x14.5	4	ZT31-3724
RMZ450	05-17	Thin Head	9mm-M6x14	4	ZT31-3424	Thin Head	10mm-M8x14.5	4	ZT31-3724
RMX450Z	10-14	Thin Head	9mm-M6x14	4	ZT31-3424	Thin Head	10mm-M8x14.5	4	ZT31-3724
RMX250R/S	89-95	Flat Head Bolt	M6x16	6	ZT31-6166	Flat Head Bolt	M6x16	6	ZT31-6166
	96-98	Counter Sunk	M6x18	6	ZT31-2656	Counter Sunk	M6x18	6	ZT31-2656
DRZ125L	03-09	Flat Head Bolt	M6x20	3	ZT31-6203 #3	-	-	-	-
DRZ400E/S	00-16	Counter Sunk	M6x18	6	ZT31-2656	Counter Sunk	M6x18	6	ZT31-2656
DRZ400SM	05-17	Counter Sunk	M6x18	6	ZT31-2656	Counter Sunk	M6x18	6	ZT31-2656
SX125R/200R	85-91	Thin Head	10mm-M8x20	4	ZT31-3744	-	-	-	-
TS125R/200R	89-97	Thin Head	10mm-M8x20	4	ZT31-3744	-	-	-	-
Diebel125/200	93-06	Thin Head	10mm-M8x20	4	ZT31-3744	-	-	-	-
DR250R/RX	95-05	Flat Head Bolt	M6x16	6	ZT31-6166	Thin Head	10mm-M8x20	4	ZT31-3744
DR250S/350S	90-94	Thin Head	10mm-M8x20	4	ZT31-3744	-	-	-	-
DR650SE	96-00	Thin Head	10mm-M8x20	6	ZT31-3746	Thin Head	10mm-M8x20	6	ZT31-3746
DR800S	91-96	Thin Head	10mm-M8x20	6	ZT31-3746	Thin Head	10mm-M8x20	6	ZT31-3746
50SX	07-13	Flange Bolt	6mm-M6x13	4	ZT31-0234	Flange Bolt	6mm-M6x16	5	ZT31-0265
	14-17	Flange Bolt	6mm-M6x13	4	ZT31-0234	Flange Bolt	6mm-M6x16	4	ZT31-0264
65SX	02-05	Flat Head Bolt	M6x16	3	ZT31-6163 #3	Flange Bolt	6mm-M6x13	4	ZT31-0234
	06-17	Flange Bolt	6mm-M6x16	3	ZT31-0263 #3	Flange Bolt	6mm-M6x16	4	ZT31-0264
85SX	03-17	Flange Bolt	6mm-M6x13	4	ZT31-0234	Flange Bolt	6mm-M6x16	4	ZT31-0264
125SX	01-17	Flange Bolt	6mm-M6x13	6	ZT31-0236	Flange Bolt	6mm-M6x13	6	ZT31-0236
150SX	09-17	Flange Bolt	6mm-M6x13	6	ZT31-0236	Flange Bolt	6mm-M6x13	6	ZT31-0236
250									

FLIGHT TOP BRIDGE

for
RACING/
STREET



ZETA FLIGHT TOP BRIDGE

- Maximum light weight design with great rigidity balance.
- Made of durable CNC machined aluminum with black anodized finish.
- Comes with titanium front fork clamp bolts.

	Bike	Year	Part #
YAMAHA	YZF-R25/R3	15-16	ZS41-3210
	YZF-R1/M	15-16	ZS41-3810
KAWASAKI	Ninja 250/R #	08-16	ZS41-1210
	Ninja ZX-10R	16	ZS41-1810
	Ninja H2/R	15-16	ZS41-1850
SUZUKI	GSX-R600/750	06-16	ZS41-2610
	GSX-R1000	09-16	ZS41-2810
BMW	S1000RR	15-16	ZS41-5810
DUCATI	1198/S/R, 1098/S/R, 848/EVO	07-11	ZS41-6810
	1199S/R, 1299S, 899 Panigale	12-15	ZS41-6820
APRILIA	RSV4 R/FACTORY APRC	09-14	ZS41-7810

Spec
Material : 6061-T6 Aluminium
Clamp Bolt : Ti-6Al-4V

Cannot use stock handlebars.

1199S PANIGALE



YZF-R1



[Design]

Rounded edge design for less stress concentration and rigidity.



[Rigidity Balance]

Top bridge body is flexible when the bike is deeply banked for smooth front fork movement.



[Factory Look]

Recent light weight design used on Moto GP and WSBK race bikes.



[Light weight design]

Super light weight design, but still provides great rigidity balance. RSV4 stock top bridge weight = 534g, ZETA top bridge = 494g. ZETA is 40g lighter than stock RSV4 top bridge.



[Ti-6AL-4V bolt]

Clamp bolt is made of titanium for light weight and stable tightening torque.

Aim for fastest lap!

Used by
TRICK STAR Racing

FLIGHT HANDLE

ZETA
HIGH PERFORMANCE PRODUCTS
STREET

CONTROL



LEVER



BODY



ELECTRICAL



Short offset

STD



for
RACING

ZETA FLIGHT HANDLE

- ZETA Clip on handle for racing use.
- FIM EWC 80th Bol d'Or 24-hour endurance race third place winning TRICK STAR Racing use.
- All bolts and pins are made of Ti-6Al-4V titanium.
- Clamp body is made of 7009-T6 aluminum with precision CNC light weight finish for light weight and durability.
- Handlebar is made of 6061-T6 aluminum to ease impact and protect clamp body in event of a crash.
- Available in standard and short offset handle with many clamps and handlebar angles.

type	Part number	Clamp			Handlebar length(mm)
		Diameter	Offset(mm)	Angle	
STD	ZS03-0133	φ50	39	6°	270
	ZS03-0135	φ50	39	9°	270
	ZS03-0167	φ53	40.5	6°	270
SHORT	ZS03-0233	φ50	29	6°	205(Effective length)
	ZS03-0237	φ50	29	12°	205(Effective length)
	ZS03-0257	φ52	30	12°	205(Effective length)

Spec

Material(clamp)	: A7009-T6
Material(bar)	: A6061-T6
Surface finish	: Color anodized finish
Handlebar out side diameter	: φ22.2
Handlebar inside diameter	: φ16
Clamp thickness	: 36 mm

FUNCTION



HIGH QUALITY

Made of machined A7009-T6 aluminum for light weight.
All bolts and pins are made of Ti-6Al-4V titanium.

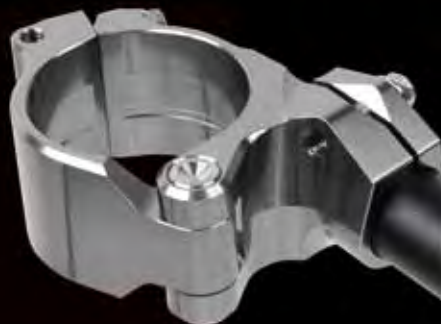

CLAMP

Clamp attaching design for quick handle installation and removal.
Gap on the inner side of clamp provides better contact pressure.

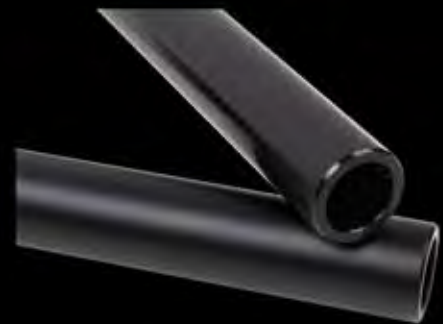

HANDLEBAR

Throttle side has polished finish for smooth throttle control.
Clutch side has short peening finish for secure grip holding.



Handlebar adjustable system

Provides comfort or sport riding handlebar positions.

for STREET

ZETA

PILOT HANDLE

- Provide many handlebar positions on your bike, great to use for sport riding and touring.
- Clamp and handlebar are made of A6061-T6 aluminum for durability.
- Clamp body is CNC machined, available red or titanium anodized colors.
- Handlebar bracket available in 2 different heights, 25mm and 45mm.
- Provides 2 different handlebar angles, 5 degree or 10 degree by changing handlebar bracket position on clamp body.
- Optional offset plate available if you need more space between OE clamp and handle bracket.
- Replacement handles available.

Size	Part #			
	Ti-color		Red	
Fork clamp	High (45 mm)	Middle (25 mm)	High (45 mm)	Middle (25 mm)
φ37	ZS03-1371	ZS03-1372	ZS03-1375	ZS03-1376
φ41	ZS03-1411	ZS03-1412	ZS03-1415	ZS03-1416
φ43	ZS03-1431	ZS03-1432	ZS03-1435	ZS03-1436
φ50	ZS03-1501	ZS03-1502	ZS03-1505	ZS03-1506
φ53	ZS03-1531	ZS03-1532	ZS03-1535	ZS03-1536

Spec

Material : A6061-T06
 Surface finish : Color anodized finish
 Handlebar out side diameter : φ 22.2
 Handlebar inside diameter : φ 16
 Handlebar length : 270 mm
 Clamp thickness : 34 mm
 (30 mm for φ 37 clamp)



Red

Ti-color



CLAMP

Gap on the inner side of clamp provides better contact pressure and prevents clamp from moving on to front forks and handlebars.



HIGH QUALITY

Fully machined from A6061-T6 aluminum, to achieve a light weight and durable product.

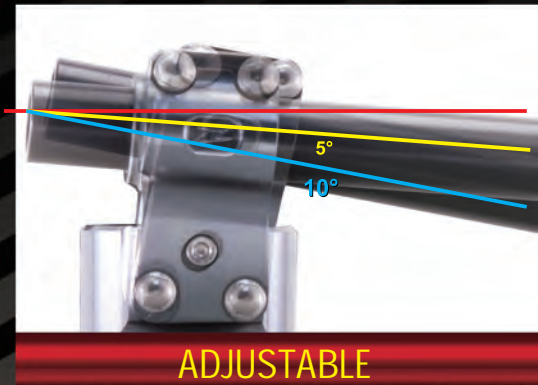

ADJUSTABLE

Provides 2 different handlebar angles, 10 degree angle for sport riding, 5 degree angle for comfortable riding position.

Replacement



REPLACEMENT BARS

ZS03-8002 * Required drilling hole for control switch.

Optional



OFFSET PLATE KIT (5 mm)

Use this plate kit when you need more space between OE clamp and handle bracket.

ZS03-1911 Ti-color
 ZS03-1915 Red

* Comes with attachment bolts.



High (45 mm)

Middle (25 mm)

HANDLEBAR BRACKET KIT

High (45 mm)

ZS03-1941 Ti-color
 ZS03-1945 Red

Middle (25 mm)

ZS03-1942 Ti-color
 ZS03-1946 Red



Bike	Year	Gold	Ti-color
HONDA			
CBR250R	11-16		
CB250F	14-16		
CBR300R	15-16		
CB300F	15-16		
400X	13-15		
CB400F	13-15		
CB400SF	92-16		
CBR400R	13-15		
CB500X	13-16		
CB500F	13-16		
CBR500R	13-16		
CBR600RR	03-16	ZS48-1104	ZS48-1108
CB650F	14-15		
CBR650F	14-16		
NC700X	12-16		
NC750S/X	14-15		
VFR800	98-09		
VFR800F	14-15		
CB1000R	11-16		
CBR1000RR	04-16		
CB1100	10-15		
CBR1100XX	97-03		
VFR1200F	10-14		
CB1300SF	03-16		
YAMAHA			
MT-25	16	ZS48-1404	ZS48-1408
MT-03	16	ZS48-1404	ZS48-1408
YZF-R25	15-16	ZS48-1404	ZS48-1408
YZF-R3	15-16	ZS48-1404	ZS48-1408
FZ6	04-08	ZS48-1414	ZS48-1418
FZ6R	07-15	ZS48-1414	ZS48-1418
YZF-R6	06-16	ZS48-1404	ZS48-1408
FZ07	15-16	ZS48-1414	ZS48-1418
MT07	14-16	ZS48-1414	ZS48-1418
FZ8	11-15	ZS48-1404	ZS48-1408
FZ09	14-16	ZS48-1414	ZS48-1418
MT09	14-16	ZS48-1414	ZS48-1418
FZ1 (North America)	01-15	ZS48-1414	ZS48-1418
FZ1 FAZER(Japan)	08-15	ZS48-1414	ZS48-1418
YZF-R1	98-14	ZS48-1404	ZS48-1408
XJR1200	94-96	ZS48-1414	ZS48-1418
FJR1300	03-15	ZS48-1404	ZS48-1408
XJR1300	98-15	ZS48-1414	ZS48-1418
V-MAX	09-15	ZS48-1404	ZS48-1408

Bike	Year	Gold	Ti-color
KAWASAKI			
Ninja 250	13-16		
Ninja 300	13-16		
Ninja 250R	08-12		
Z250	13-16		
ER-4n	11-13		
Ninja 400R	11-13		
Ninja 400	14-16		
ER-6f	07-10		
ER-6n	06-14		
ZX-6R	00-16		
ZX-6RR	03-05		
Ninja 650	12-16		
Ninja 650R	09-11		
Z750	04-05		
Z750S	05		
ZX-7R	00-02	ZS48-1204	ZS48-1208
ZX-7RR	96-97		
Z800	13-16		
ZX-9R	99-03		
Ninja 1000	11-16		
Versys1000	12-16		
Z1000	03-16		
ZX-10R	11-15		
ZRX1100	97-00		
ZRX1100II	97-00		
ZRX1200DAEG	09-16		
ZRX1200R	01-08		
ZRX1200S	01-04		
ZX-12R	00-06		
ZZR1200	02-05		
ZX-14R	12-16		
ZZR1400	06-11		
SUZUKI			
GSR250	12-15		
GSR250S	14-15		
GW250	12-15		
INAZUMA250	12-15		
GLADIUS400	09-14	ZS48-1014	ZS48-1018
GSR400	06-14		
GSR-R600	01-03		
V-Strom650	04-15		
GSX-R750	00-03		
GSX-R1000	01-04		

ZETA BAR END PLUGS

- Made of high strength aluminum and stainless steel.
- Functions as a weight to prevent unpleasant vibration.
- Design to fit specific models, easy to install.
- Available in gold and titanium colors.



Universal L

Universal S

ZETA BAR END PLUGS Universal

- Universal bar end plug for sport bike.
- Available universal S and L models.
- L model comes with stainless steel bar weight to prevent unpleasant vibration.
- Available in gold and titanium colors.
- * handlebar inner diameter 13.5 mm - 19 mm

Size	Gold	Ti-color
Universal S	ZS48-1004	ZS48-1008
Universal L	ZS48-1014	ZS48-1018



ZETA TOP CAP INITIAL ADJUSTER

- Top cap initial adjuster for Ninja 250/300 and YZF-R25/R3
- Allows you to adjust spring pre load.
- Pre load adjustable range is -5mm to +10mm, provides pre load setting for racing use and soften for light weight riders.
- Integrated air bleeder, bleeds high pressure air without any tools from the front fork after hard and high speed riding.
- * Ninja 250/300 required to change handlebar to clip on handlebar for installation.

Bike	Year	Gold
YAMAHA	YZF-R25	15-16
YAMAHA	YZF-R25ABS	15-16
YAMAHA	YZF-R3	15-16
KAWASAKI	Ninja250R	08-12
KAWASAKI	Ninja250	13-16
KAWASAKI	Ninja250ABS	13-16

ZETA FORK TOP CAP Ninja250/300

- CNC machined aluminum front fork cap for Ninja 250/300.
- Use this fork cover cap when you change to aftermarket clip on handles.
- Black anodized finish with laser printed logo.
- Comes in pairs.

ZS59-8011 Black



High Type 1

Medium Type 2

Medium Type 1

Low Type 2

Low Type 1

Medium Type 1

CB400SF

High Type 1

CB500X

ZETA
GT HANDLEBAR

- Handlebar sizes which are designed for a relaxed and comfortable ride.
- Laser printed handlebar positioning gauge for accurate bar position setting.
- Made of durable aluminum with shot peened anodized finish.
- Matte titanium anodized surface finish.
- Handlebar diameter : 22.2 mm / Bar end inner diameter : 13.5 mm

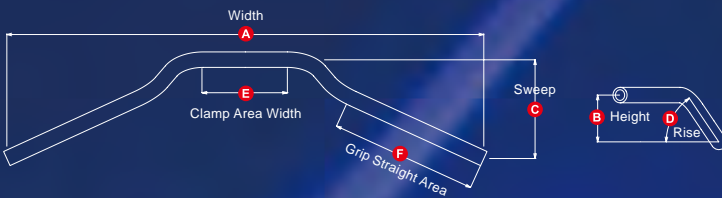

Model	Part#	Handlebar dimensions					
		A	B	C	D	E	F
Low type-1	ZS07-1008	670	52	116	60°	115	200
Low type-2	ZS07-1018	680	63	135	67°	120	205
Medium type-1	ZS07-1108	685	67	142	56°	120	205
Medium type-2	ZS07-1118	685	71	152	62°	120	205
High type-1	ZS07-1208	740	98	150	63°	120	200

Laser printed logos and handlebar positioning gauge for accurate handlebar position setting.



Ninja 400R [ZS86-1208](#)

ZETA
HANDLEBAR STABILIZER

- Made of CNC machined aluminum with anodized finish.
- Durable yet light weight design.
- Available in titanium color.
- Comes with special stainless bolts.

Bike	Year	Part #
HONDA		
GROM	13-15	ZS33-1108
MSX125	13-15	ZS33-1108
CB250F	14-16	ZS33-1108
CB300F	15-16	ZS33-1108
VTR/VTR-F	09-14	ZS33-1108
400X	13-15	ZS33-1108
CB400F	13-15	ZS33-1108
CB400SF	92-16	ZS33-1108
CB500X	13-16	ZS33-1108
CB500F	13-16	ZS33-1108
CB650F	14-15	ZS33-1108
NC700S/X	12-16	ZS33-1108
NC750S/X	14-15	ZS33-1108
CB1100	10-15	ZS33-1118
CB1300SF	03-16	ZS33-1118

Bike	Year	Part #
KAWASAKI		
Z250	13-16	ZS33-1218
ER-4n	11-13	ZS33-1208
Ninja 400R	11-13	ZS33-1208
Ninja 400	14-16	ZS33-1208
ER-6f	09-10	ZS33-1208
ER-6n	09-11	ZS33-1208
Ninja 650	12-16	ZS33-1208
Ninja 650R	09-11	ZS33-1208
Z800	13-16	ZS33-1218

ZETA
BAR CLAMP

- Made of CNC machined aluminum with anodized finish.
- Exclusive look on your handlebar clamp.
- Available in gold and titanium colors.

Part #	Color
ZS40-1104	Gold
ZS40-1108	Ti-color

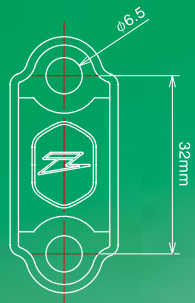

CONTROL



LEVER



BODY



ELECTRICAL





ZETA LEVER GUARD

- Lever guard prevents accidental brake lever incidents at the race, track day or street riding.
- Made of A7079 T6 aluminum for durable construction, with length adjustable function to fit most bikes.
- Can also be used for clutch lever side by changing the part direction.
- Available Gold and Titanium colors.
- Sold by unit quantity (One side only)
- Can be used for handlebar with inner diameter from 13.5 mm to 19 mm.

Part #	Color
ZS72-1000	Black
ZS72-1004	Gold
ZS72-1008	Ti-color



Replacement Arm
Part number **ZS72-1094**

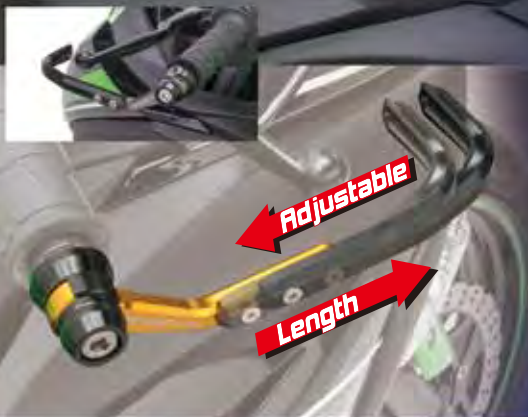

CONTROL



LEVER



BODY



ELECTRICAL



ZETA BAR RISE KIT Ninja250 and CBR250R

- Bar rise spacer provides higher bar position.
- Made of CNC machined aircraft grade aluminum and titanium anodized finish.

Part #	Bike	Year	Spacer thickness
ZS53-1108	CBR250R	11-	10 mm
ZS53-1208	Ninja 250	08-	8 mm



- Universal bar riser kit for over sized (28.6 mm, 1 1/8") bar mount and standard sized (22.2 mm, 7/8").
- Provides 19 mm and 30 mm higher bar position than stock bar position.
- For use on bar handle sports bikes.
- Comes with bar clamp bolts. - Made of A7009-T6 aluminum.

ZETA BAR RISE KIT 7/8 in (22.2 mm)

Part #	Size (H)
ZE53-0119	19 mm
ZE53-0130	30 mm

ZETA BAR RISE KIT 1 1/8 in (28.6 mm)

Part #	Size (H)
ZE53-0219	19 mm
ZE53-0230	30 mm

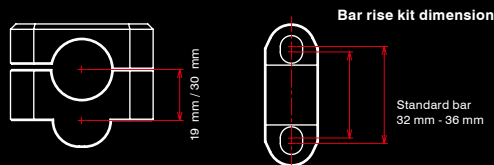

ZETA BAR RISE KIT OFFSET 7/8 in (22.2 mm)

- Handlebar rise and offset kit.
- Provides 26 mm higher, 20 mm back and forth positions from stock handlebar position.
- Provide comfort riding position for sport bike with 20 mm backward position.

Part number **ZE53-0526**

Bar rise kit offset dimension

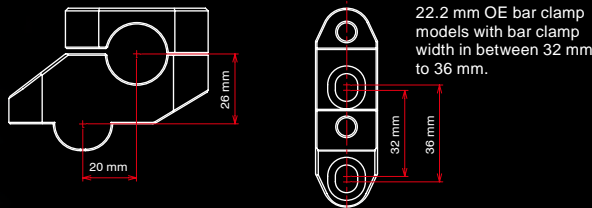

FLIGHT LEVER SERIES



Photo credit: Yoshimura Japan
YOSHIMURA SUZUKI
Shell ADVANCE RACING TEAM

CONTROL



LEVER



BODY



ELECTRICAL



for
RACING



4 Finger

3 Finger

ZETA

FLIGHT PERCH 3 Finger & 4 Finger

- Clutch perch set for cable type clutch developed with YOSHIMURA racing team.
- Flight perch comes with 3 fingers short lever arm.
- Developed with World Super Bike racing team, Crescent Suzuki.
- Comes with quick cable adjuster for quick and easy clutch play adjustment, even during the ride.
- Lever bearing for less friction. Fully CNC machined, super light weight design.
- Conforms to FIM and MFJ regulations.

ZS60-5886 3 Finger ZS60-5883 4 Finger

FLIGHT PERCH

FLIGHT LEVER



Vent Holes

Lever body is designed to decrease wind pressure, and in case of a fall, the breaking point is pre-calculated to avoid worst case "DNF".

Lever End Ball

19 mm lever end ball complies to MFJ and FIM regulations.



Folding lever

Lever swings upward in the event of crash and prevents lever breakage.



Quick Cable Adjuster

Large size 1/6 rotating wire adjuster. Easy to adjust clutch play even during the ride.

Lever Adjuster Bolt

Simple and light weight design for non step adjustment.



Quick Clamp System

Hinge style clamp for easy and quick maintenance. Hinge pin is made of titanium alloy.

FLIGHT LEVER Replacement

FLIGHT PERCH Replacement



Clutch Lever Arm

Lever Type	Part number
L4SH	ZS60-5980
L4SP	ZS60-5980
L3SP	ZS60-5995

Brake Lever Arm

Lever Type	Part number
R4SH	ZS60-3990
R3SH	ZS60-3995

Adjust Knob

ZS60-9119

Lever Assy

Lever Type	Part number
4 Finger	ZS60-5909
3 Finger	ZS60-5906

Lever Arm

ZS60-5990

Perch Assy

ZS60-5919

Adjuster

Color	Part number
Red	ZS60-5929
Blue	ZE43-9394

Bolt set

ZS60-5939



ZETA FLIGHT LEVER Brake/Clutch 3 Finger & 4 Finger

- Developed with YOSHIMURA Racing team and World Super Bike racing team, Crescent Suzuki.
- Holes on lever body is designed to decrease wind pressure up to over 300 km / h.
- The braking point is pre-calculated in case of a fall.
- Fully CNC machined from A7009 / A6061 aluminum, super light weight design.
- Conforms to FIM and MFJ regulations.
- Available 3 finger and 4 finger lever arm lengths.

Used by
**AMA SUPAR BIKE
YOSHIMURA RACING TEAM**



4 Finger

3 Finger

Clutch lever					
Bike	Year	4 Finger	Lever Type	3 Finger	Lever Type
HONDA					
CBR600RR	03-16	ZS60-5010	L4SP	ZS60-5015	L3SP
CBR954	02-03	ZS60-5010	L4SP	ZS60-5015	L3SP
CBR1000RR	08-16	ZS60-5010	L4SP	ZS60-5015	L3SP
CBR1000S	14-16	ZS60-5010	L4SP	ZS60-5015	L3SP
CBR1000R	11-16	ZS60-5010	L4SP	ZS60-5015	L3SP
YAMAHA					
XJ6N	09-15	ZS60-5210	L4SP	ZS60-5215	L3SP
YZF-R6	99-16	ZS60-5210	L4SP	ZS60-5215	L3SP
YZF-R1/M/S	00-16	ZS60-5210	L4SP	ZS60-5215	L3SP
MT-07	14-16	ZS60-5210	L4SP	ZS60-5215	L3SP
MT-09	14-16	ZS60-5210	L4SP	ZS60-5215	L3SP
FZ-1/Fazer	06-15	ZS60-5210	L4SP	ZS60-5215	L3SP
KAWASAKI					
ZX-6R	00-16	ZS60-5110	L4SP	ZS60-5115	L3SP
ZX-10R	04-16	ZS60-5110	L4SP	ZS60-5115	L3SP
ZX-12R	00-06	ZS60-5110	L4SP	ZS60-5115	L3SP
ZX-9R	00-03	ZS60-5110	L4SP	ZS60-5115	L3SP
Z750	07-10	ZS60-5110	L4SP	ZS60-5115	L3SP
Z1000	03-16	ZS60-5110	L4SP	ZS60-5115	L3SP
Ninja1000	11-16	ZS60-5110	L4SP	ZS60-5115	L3SP
Versys1000	12-14	ZS60-5110	L4SP	ZS60-5115	L3SP
SUZUKI					
GSX-R750/600	08-16	ZS60-5210	L4SP	ZS60-5215	L3SP
GSX-R1000	05-06	ZS60-5210	L4SP	ZS60-5215	L3SP
GSX-R1000	09-16	ZS60-5210	L4SP	ZS60-5215	L3SP
GSX-S1000/F	16	ZS60-5210	L4SP	ZS60-5215	L3SP
BMW					
S1000RR	10-14	ZS60-5810	L4SP	ZS60-5815	L3SP
S1000RR	15-16	ZS60-5830	L4SP	ZS60-5835	L3SP
S1000R	14-16	ZS60-5830	L4SP	ZS60-5835	L3SP
HP4	13-14	ZS60-5810	L4SP	ZS60-5815	L3SP
OTHER					
Brembo Radial Master19x20 for Ratio		ZS60-5710	L4SH	-	-
Brembo Radial Master19x18 16x18 for Ratio		ZS60-5720	L4SH	-	-
Brembo Radial MasterRCS		ZS60-3730	-	-	-

Brake lever					
Bike	Year	4 Finger	Lever Type	3 Finger	Lever Type
HONDA					
CBR600RR	07-16	ZS60-3010	R4SH	ZS60-3015	R3SH
CBR1000RR	04-16	ZS60-3010	R4SH	ZS60-3015	R3SH
CBR1000S	14-16	ZS60-3010	R4SH	ZS60-3015	R3SH
CBR1000R	11-16	ZS60-3010	R4SH	ZS60-3015	R3SH
YAMAHA					
YZF-R6	05-16	ZS60-3610	R4SH	ZS60-3615	R3SH
YZF-R1/M/S	15-16	ZS60-3620	R4SH	ZS60-3625	R3SH
YZF-R1	04-14	ZS60-3610	R4SH	ZS60-3615	R3SH
V-MAX	09-16	ZS60-3610	R4SH	ZS60-3615	R3SH
MT-01	05-09	ZS60-3610	R4SH	ZS60-3615	R3SH
KAWASAKI					
ZX-6R	07-16	ZS60-3210	R4SH	ZS60-3215	R3SH
ZX-10R	06-15	ZS60-3210	R4SH	ZS60-3215	R3SH
ZX-14R	06-16	ZS60-3210	R4SH	ZS60-3215	R3SH
Z1000	07-16	ZS60-3210	R4SH	ZS60-3215	R3SH
Ninja1000	11-16	ZS60-3210	R4SH	ZS60-3215	R3SH
1400GTR/ABS	08-16	ZS60-3210	R4SH	ZS60-3215	R3SH
SUZUKI					
GSX-R750/600	04-16	ZS60-3410	R4SH	ZS60-3415	R3SH
GSX-R1000	05-16	ZS60-3410	R4SH	ZS60-3415	R3SH
GSX-S1000/F	16	ZS60-3410	R4SH	ZS60-3415	R3SH
B-KING	07-09	ZS60-3410	R4SH	ZS60-3415	R3SH
BMW					
S1000RR	10-16	ZS60-3410	R4SH	ZS60-3415	R3SH
S1000R	14-16	ZS60-3410	R4SH	ZS60-3415	R3SH
HP4	13-14	ZS60-3410	R4SH	ZS60-3415	R3SH
OTHER					
Brembo Radial Master19x20 for Ratio		ZS60-3710	R4SH	ZS60-3715	R3SH
Brembo Radial Master19x18 16x18 for Ratio		ZS60-3720	R4SH	ZS60-3725	R3SH
Brembo Radial MasterRCS		ZS60-3730	-	-	-



ZETA FLIGHT LEVER Remote Adjuster

- Provides fine adjustment to the brake lever from the left side handlebar.
- Able to tighten slack in your brakes with your free hand without letting off the throttle.
- CNC machined handlebar support included.

Part Number **ZS60-3989**

Replacement wire **ZS60-3998**

Used by
**AMA SUPAR BIKE
YOSHIMURA RACING TEAM**

Pilot LEVER

ZETA PILOT LEVER

- High quality CNC machined levers for sport bikes.
- Folding lever system to prevent lever breakage.
- Short lever arm for sport riding.
- Available in black and titanium anodized colors.

for
STREET

Ninja H2



CONTROL



LEVER



BODY



ELECTRICAL



LEVER TYPE

L3WA/R3WA

L3WB/R3WB

FUNCTION



FOLDING UP / DOWNWARD

Lever swings upward or downward in the event of crash to prevent lever breakage.



FOLDING FORWARD

Lever swings forward in the event of crash to prevent lever breakage.



CNC MACHINED LEVER

Precision CNC machined finish to reduce weight and for better lever control.



ADJUST KNOB

Provides more sensitive lever adjusting positions than OEM levers. (20 lever positions)

Pilot lever Clutch

BIKE	Year	Ti-color	Black	Lever Type
HONDA				
CB1300SF/SB/ST	98-16	ZS61-2020	ZS61-2025	L3WA
CB1000SF	92-97	ZS61-2020	ZS61-2025	L3WA
CB1100/EX	10-16	ZS61-2020	ZS61-2025	L3WA
CBR1100XX	97-06	ZS61-2020	ZS61-2025	L3WA
CBR1000RR	04-07	ZS61-2020	ZS61-2025	L3WA
CBR1000S	08-16	ZS61-2010	ZS61-2015	L3WA
CBR954RR	14-16	ZS61-2010	ZS61-2015	L3WA
CBR900RR	02-03	ZS61-2010	ZS61-2015	L3WA
CBR600RR	03-16	ZS61-2010	ZS61-2015	L3WA
CB1000R	11-16	ZS61-2020	ZS61-2025	L3WA
X-4	97-03	ZS61-2020	ZS61-2025	L3WA
VFR1200F	10-16	ZS61-2020	ZS61-2025	L3WA
VFR800	03-08	ZS61-2020	ZS61-2025	L3WA
VFR800F/X	14-16	ZS61-2020	ZS61-2025	L3WA
VTR1000F	98-05	ZS61-2020	ZS61-2025	L3WA
YAMAHA				
V-MAX	09-16	ZS61-2610	ZS61-2615	L3WA
MT-10/FZ-10	17	ZS61-2410	ZS61-2415	L3WA
MT-01	05-09	ZS61-2610	ZS61-2615	L3WA
MT-09 Tracer	15-16	ZS61-2410	ZS61-2415	L3WA
MT-09FZ-09	14-16	ZS61-2410	ZS61-2415	L3WA
MT-07FZ-07	14-16	ZS61-2410	ZS61-2415	L3WA
XSR900	16	ZS61-2410	ZS61-2415	L3WA
YZF-R1/MS	00-16	ZS61-2410	ZS61-2415	L3WA
YZF-R6	99-16	ZS61-2410	ZS61-2415	L3WA
FZ1N/S	06-16	ZS61-2410	ZS61-2415	L3WA
FZ8N/S/Fazer	11-15	ZS61-2410	ZS61-2415	L3WA
FZ6R/Fazer	04-16	ZS61-2410	ZS61-2415	L3WA
XJR1200/1300/C	94-15	ZS61-2610	ZS61-2615	L3WA
XJ6	09-15	ZS61-2410	ZS61-2415	L3WA
XT1200Z TENERE	10-16	ZS61-2610	ZS61-2615	L3WA
H2/H2R	15-16	ZS61-2810	ZS61-2815	L3WB
1400GTR	08-16	ZS61-2220	ZS61-2225	L3WB
ZX-12R	00-07	ZS61-2210	ZS61-2215	L3WA
ZX-10R/ABS	04-16	ZS61-2210	ZS61-2215	L3WA
ZX-9R	00-03	ZS61-2210	ZS61-2215	L3WA
ZX-7R	00-02	ZS61-2610	ZS61-2615	L3WA
ZX-6R/ABS	02-16	ZS61-2210	ZS61-2215	L3WA
ZX-14R	06-16	ZS61-2220	ZS61-2225	L3WB
ZZR1200	02-03	ZS61-2610	ZS61-2615	L3WA
ZX-11	97-01	ZS61-2610	ZS61-2615	L3WA
ZXR1100/1200DAEG	97-16	ZS61-2610	ZS61-2615	L3WA
Ninja1000/ABS	11-16	ZS61-2210	ZS61-2215	L3WA
Z1000	04-16	ZS61-2210	ZS61-2215	L3WA
Z750	13-16	ZS61-2210	ZS61-2215	L3WA
Z750	07-10	ZS61-2210	ZS61-2215	L3WA
ZEPHER1100/RS	92-06	ZS61-2610	ZS61-2615	L3WA
GPZ900R	91-03	ZS61-2610	ZS61-2615	L3WA
Versys1000	12-14	ZS61-2210	ZS61-2215	L3WA
GSX1400	01-08	ZS61-2420	ZS61-2425	L3WA
GSX1300R HAYABUSA	99-16	ZS61-2420	ZS61-2425	L3WA
BANDIT1200/1250/S/F	01-16	ZS61-2420	ZS61-2425	L3WA
GSX-S1000/F	16	ZS61-2410	ZS61-2415	L3WA
GSX-R1000	05-06	ZS61-2410	ZS61-2415	L3WA
GSX-R750	07-08	ZS61-2420	ZS61-2425	L3WA
GSX-R600	09-16	ZS61-2410	ZS61-2415	L3WA
GS1200SS	06-16	ZS61-2410	ZS61-2415	L3WA
V-STORM 1000	01-02	ZS61-2420	ZS61-2425	L3WA
SV1000S	07-16	ZS61-2420	ZS61-2425	L3WA
TL1000R	03-07	ZS61-2420	ZS61-2425	L3WA
1299 Panigale/S	98-03	ZS61-2810	ZS61-2815	L3WB
1199 Panigale R/Tricolore	15-16	ZS61-2810	ZS61-2815	L3WB
1199 Panigale R	12-14	ZS61-2810	ZS61-2815	L3WB
959 Panigale	13-16	ZS61-2810	ZS61-2815	L3WB
899 Panigale	16	ZS61-2810	ZS61-2815	L3WB
1198/1098/S/R	14-15	ZS61-2810	ZS61-2815	L3WB
999/S/R	08-11	ZS61-2810	ZS61-2815	L3WB
848/749/S/R	03-07	ZS61-2810	ZS61-2815	L3WB
/EVO/EVO Corse SE	03-13	ZS61-2810	ZS61-2815	L3WB
STREETFIGHTER/S	10-13	ZS61-2810	ZS61-2815	L3WB
STREETFIGHTER 848	12-15	ZS61-2810	ZS61-2815	L3WB
HYPERMOTARD1100S/EVO	08-12	ZS61-2810	ZS61-2815	L3WB
MONSTER1200S/R	14-16	ZS61-2810	ZS61-2815	L3WB
MONSTER1100S/EVO	08-13	ZS61-2810	ZS61-2815	L3WB
MONSTER S4R/S	06-08	ZS61-2810	ZS61-2815	L3WB
MULTISTRADA1200S/PIKES PEAK/ENDURO	10-16	ZS61-2810	ZS61-2815	L3WB
DIAVEL	11-16	ZS61-2810	ZS61-2815	L3WB
DIAVEL STRADA	13	ZS61-2810	ZS61-2815	L3WB
DIAVEL CARBON	12-16	ZS61-2810	ZS61-2815	L3WB
DIAVEL DARK	13	ZS61-2810	ZS61-2815	L3WB
TRIUMPH				
Bonneville/SE/T100	11-15	ZS61-2830	ZS61-2835	L3WB
Daytona 675/R/SE	06-15	ZS61-2830	ZS61-2835	L3WB
Daytona595&600&650&955	97-05	ZS61-2830	ZS61-2835	L3WB
Scrambler	06-15	ZS61-2830	ZS61-2835	L3WB
Speed Four	03-05	ZS61-2830	ZS61-2835	L3WB
Speed Triple/R	97-15	ZS61-2830	ZS61-2835	L3WB
SprintRS/GT/ST/ST1050	99-12	ZS61-2830	ZS61-2835	L3WB
Street Triple /65/R/675/675R	08-15	ZS61-2830	ZS61-2835	L3WB
ThruXton	04-15	ZS61-2830	ZS61-2835	L3WB
Tiger 1050/SE	07-12	ZS61-2830	ZS61-2835	L3WB
Tiger 800/XC	11-14	ZS61-2830	ZS61-2835	L3WB
TT600	00-03	ZS61-2830	ZS61-2835	L3WB
OTHER				
NISSIN RADIAL CAST		ZS61-2220	ZS61-2225	L3WB

Pilot lever Brake

BIKE	Year	Ti-color	Black	Lever Type
HONDA				
CB1300SF	98-00	ZS61-1020	ZS61-1025	R3WA
CB1300SF/SB/ST	03-16	ZS61-1430	ZS61-1435	R3WA
CB400SF/SB ABS	08-13	ZS61-1020	ZS61-1025	R3WA
CB400SF/SB	14-16	ZS61-1430	ZS61-1435	R3WA
CB400SF/SB	97-16	ZS61-1430	ZS61-1435	R3WA
CBR1100XX	97-06	ZS61-1020	ZS61-1025	R3WA
CBR1000S	14-16	ZS61-1010	ZS61-1015	R3WB
CBR1000RR	04-16	ZS61-1010	ZS61-1015	R3WB
CBR900RR	98-99	ZS61-1430	ZS61-1435	R3WA
CBR600RR	07-16	ZS61-1010	ZS61-1015	R3WB
CBR600F4/F4i	99-06	ZS61-1430	ZS61-1435	R3WA
CB1000R	11-16	ZS61-1010	ZS61-1015	R3WB
X-4	97-03	ZS61-1430	ZS61-1435	R3WA
X-11	99-00	ZS61-1020	ZS61-1025	R3WA
CB1100/EX	10-16	ZS61-1430	ZS61-1435	R3WA
CB1000SF	92-97	ZS61-1430	ZS61-1435	R3WA
CB750	07-08	ZS61-1430	ZS61-1435	R3WA
VTR1000F	98-05	ZS61-1430	ZS61-1435	R3WA
VFR800	03-08	ZS61-1430	ZS61-1435	R3WA
VFR800F/X	14-16	ZS61-1430	ZS61-1435	R3WA
VFR1200X	14-16	ZS61-1430	ZS61-1435	R3WA
NVR F400	94-96	ZS61-1430	ZS61-1435	R3WA
RSR250R	87-96	ZS61-1430	ZS61-1435	R3WA
HORNE T900	02-07	ZS61-1430	ZS61-1435	R3WA
HORNE T600	98-02	ZS61-1430	ZS61-1435	R3WA
HORNE T250	96-07	ZS61-1430	ZS61-1435	R3WA
CB400SS	02-08	ZS61-1430	ZS61-1435	R3WA
VTR	98-14	ZS61-1430	ZS61-1435	R3WA
DN-01	08	ZS61-1430	ZS61-1435	R3WA
NC700S/X	12-16	ZS61-1430	ZS61-1435	R3WA
NC750S/X	14-16	ZS61-1430	ZS61-1435	R3WA
NC1000L	16	ZS61-1430	ZS61-1435	R3WA
HONDA				
V-MAX	09-16	ZS61-1610	ZS61-1615	R3WB
MT-01	05-09	ZS61-1610	ZS61-1615	R3WB
MT-09 Tracer	15-16	ZS61-1620	ZS61-1625	R3WA
MT-09/FZ-09	14-16	ZS61-1620	ZS61-1625	R3WA
MT-07/FZ-07	14-16	ZS61-1620	ZS61-1625	R3WA
XSR900	16	ZS61-1620	ZS61-1625	R3WA
YZF-R1	04-14	ZS61-1610	ZS61-1615	R3WB
YZF-R1/MS	15-16	ZS61-1630	ZS61-1635	R3WB
YZF-R6	05-16	ZS61-1610	ZS61-1615	R3WB
FZ1N/S	06-16	ZS61-1620	ZS61-1625	R3WA
FZ8N/S/Fazer	11-15	ZS61-1620	ZS61-1625	R3WA
FZ6R/Fazer	04-09	ZS61-1620	ZS61-1625	R3WA
FJR1300	01-02	ZS61-1440	ZS61-1445	R3WA
FJR1300/A	03-16	ZS61-1620	ZS61-1625	R3WA
XJR1300C	15	ZS61-1620	ZS61-1625	R3WA
XJR1200/1300	94-15	ZS61-1440	ZS61-1445	R3WA
XJR400R/R II	93-07	ZS61-1440	ZS61-1445	R3WA
TRZ250R	90-95	ZS61-1440	ZS61-1445	R3WA
XRS/SP/SPR	09-15	ZS61-1620	ZS61-1625	R3WA
J/MS	09-15	ZS61-1620	ZS61-1625	R3WA
XT1200Z TENERE	10-16	ZS61-1620	ZS61-1625	R3WA
X1600Z TENERE	08-15	ZS61-1620	ZS61-1625	R3WA
TRX850	95-99	ZS61-1440	ZS61-1445	R3WA
TDM850	97-01	ZS61-1440	ZS61-1445	R3WA
TDM900	02-03	ZS61-1440	ZS61-1445	R3WA
04-09	ZS61-1620	ZS61-1625	R3WA	
HONDA				
H2/H2R	15-16	ZS61-1810	ZS61-1815	R3WB
1400GTR/ABS	08-16	ZS61-1010	ZS61-1015	R3WB
ZX-12R	00-07	ZS61-1440	ZS61-1445	R3WA
ZX-10R/ABS	06-15	ZS61-1010	ZS61-1015	R3WB
ZX-6R/ABS	07-16	ZS61-1010	ZS61-1015	R3WB
ZX-6R	02-04	ZS61-1440	ZS61-1445	R3WA
ZX-14R	06-16	ZS61-1010	ZS61-1015	R3WB
ZZR1200	02-05	ZS61-1440	ZS61-1445	R3WA
ZX-11	97-01	ZS61-1440	ZS61-1445	R3WA
ZRX1100/1200/DAEG	97-16	ZS61-1440	ZS61-1445	R3WA
Ninja1000/ABS	11-16	ZS61-1010	ZS61-1015	R3WB
Ninja400/650	09-16	ZS61-1010	ZS61-1015	R3WB
Z750	04-05	ZS61-1440	ZS61-1445	R3WA
Z750S	04-07	ZS61-1440	ZS61-1445	R3WA
Z1000	03-06	ZS61-1440	ZS61-1445	R3WA
07-16	ZS61-1010	ZS61-1015	R3WB	
ZEPHER750/1100/RS	92-06	ZS61-1440	ZS61-1445	R3WA
GPZ900R	91-03	ZS61-1440	ZS61-1445	R3WA
ZZR250/400	90-07	ZS61-1440	ZS61-1445	R3WA
ZRX400/II	94-08	ZS61-1440	ZS61-1445	R3WA
ZEPHERX	89-06	ZS61-1440	ZS61-1445	R3WA
ZR-7S	99-05	ZS61-1440	ZS61-1445	R3WA
Versys1000	12-14	ZS61-1440	ZS61-1445	R3WA
15-16	ZS61-1010	ZS61-1015	R3WB	
Versys650	07-08	ZS61-1440	ZS61-1445	R3WA
09-16	ZS61-1010	ZS61-1015	R3WB	
ER-6n/f	06-08	ZS61-1440	ZS61-1445	R3WA
09-14	ZS61-1010	ZS61-1015	R3WB	
BALIUS/II	91-07	ZS61-1440	ZS61-1445	R3WA
SUZUKI				
GSX1400	01-08	ZS61-1440	ZS61-1445	R3WA
GSX1300R HAYABUSA	99-16	ZS61-1440	ZS61-1445	R3WA
BANDIT1200/1250/S/F	01-16	ZS61-1440	ZS61-1445	R3WA
GSX-S1000/F	16	ZS61-1440	ZS61-1445	R3WA
GSX-R1000	05-06	ZS61-1410	ZS61-1415	R3WB
07-08	ZS61-2420	ZS61-2425	L3WA	
GSX-R750	09-16	ZS61-2410	ZS61-2415	L3WA
GSX-R600	06-16	ZS61-2410	ZS61-2415	L3WA
GS1200SS	01-02	ZS61-2420	ZS61-2425	L3WA
V-STORM 1000	07-16	ZS61-2420	ZS61-2425	L3WA
SV1000S	03-07	ZS61-2420	ZS61-2425	L3WA
TL1000R	98-03	ZS61-2420	ZS61-2425	L3WA
SUZUKI				
1299 Panigale/S	15-16	ZS61-2810	ZS61-2815	L3WB
1199 Panigale R/Tricolore	12-14	ZS61-2810	ZS61-2815	L3WB
1199 Panigale R	13-16	ZS61-2810	ZS61-2815	L3WB
959 Panigale	16	ZS61-2810	ZS61-2815	L3WB
899 Panigale	14-15	ZS61-2810	ZS61-2815	L3WB
1198/1098/S/R	08-11	ZS61-2810	ZS61-2815	L3WB
999/S/R	03-07	ZS61-2810	ZS61-2815	L3WB
848/749/S/R	03-13	ZS61-2810	ZS61-2815	L3WB
/EVO/EVO Corse SE	03-13	ZS61-2810	ZS61-2815	L3WB
STREETFIGHTER/S	10-13	ZS61-2810	ZS61-2815	L3WB
STREETFIGHTER 848	12-15	ZS61-2810	ZS61-2815	L3WB
HYPERMOTARD1100S/EVO	08-12	ZS61-2		



■ Pivot



Pivot design with return spring allows the lever to fold outward to prevent bending or breaking.

■ Adjustable



Adjustable reach system provides the perfect lever position for all riders.

■ CNC Machined lever arm



Machined ZETA logo provides better lever grip.

■ Lever Type

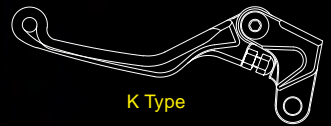

K Type

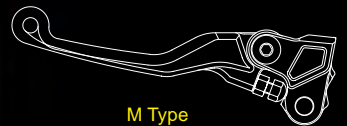

M Type

PIVOT LEVER SET
CNC MACHINED CP

ZETA PIVOT LEVER SET STREET

- Pivot lever set for sport bike.
- CNC Machined aluminum folding levers.
- The pivot design allows the lever to fold outward to prevent bending or breaking in the event of a crash.
- Made of CNC machined aircraft grade aluminum.
- Available titanium and black anodized colors.



Bike	Year	Pivot Lever CP		Lever Type	
		Black	Ti-color	4 Finger	Clutch Brake
GROM	13-17	ZS62-1020	ZS62-1028	K	K
CB250F/300F	14-16	ZS62-1020	ZS62-1028	K	K
CBR250R/300R	11-16	ZS62-1020	ZS62-1028	K	K
NSR250R	89-96	ZS62-1010	ZS62-1018	K	M
VTR/VTR-F	98-15	ZS62-1010	ZS62-1018	K	M
H 400X	13-15	ZS62-1020	ZS62-1028	K	K
CB400F	13-15	ZS62-1020	ZS62-1028	K	K
CB500X/F	13-16	ZS62-1020	ZS62-1028	K	K
CBR400R	13-15	ZS62-1020	ZS62-1028	K	K
NC700S/X	12-16	ZS62-1010	ZS62-1018	K	M
NC750S/X	14-16	ZS62-1010	ZS62-1018	K	M
MT-25	16				
Y MT-03	16				
YZF-R25	15-16	ZS62-1610	ZS62-1618	K	M
YZF-R3	15-16				
K Ninja250SL	15-16				
Ninja250/300/R	08-17	ZS62-1210	ZS62-1218	K	K
Z250/300	15-16				



ZETA PIVOT LEVER CP

- Pivot lever for sport bike.
- CNC Machined aluminum folding levers.
- The pivot design allows the lever to fold outward to prevent bending or breaking in the event of a crash.
- Hard anodized finish, made of CNC machined aircraft grade aluminum.
- Exclusively designed for each bike, 3 and 4 finger lever lengths available.

Pivot Lever Street Clutch (CP)					
Bike	Year	4 Finger	3 Finger	Type	
GROM	13-17				
CB250F/300F	14-16				
CBR250R/300R	11-16				
VTR/VTR-F	98-15				
NSR250R	89-96				
H 400X	13-15	ZE42-4115	-	K	
CB400F	13-15				
CB500X/F	13-16				
CBR400R	13-15				
CBR500R	13-16				
NC700S/X	12-16				
NC750S/X	14-16				
K Ninja250SL	15-16				
Ninja250/300/R	08-17	ZE42-4127	ZE42-3127	K	
Z250/300	13-16				

Pivot Lever Street Brake (CP)					
Bike	Year	4 Finger	3 Finger	Type	
GROM	13-17	ZE41-4145	ZE41-3145	K	
CB250F/300F	14-16	ZE41-4145	ZE41-3145	K	
CBR125R/250R/300R	11-16	ZE41-4145	ZE41-3145	K	
HORNET250	96-07	ZE41-4298	-	M	
NSR250R	87-96	ZE41-4298	-	M	
VTR/VTR-F	98-15	ZE41-4298	-	M	
H 400X	13-15	ZE41-4145	ZE41-3145	K	
CB400F	13-15	ZE41-4145	ZE41-3145	K	
CB500X/F	13-16	ZE41-4145	ZE41-3145	K	
CB400Fpur	97-98	ZE41-4298	-	M	
CB400SS	02-08	ZE41-4298	-	M	
CBR400R	13-15	ZE41-4145	ZE41-3145	K	
CBR500R	13-16	ZE41-4145	ZE41-3145	K	
CBR400RR	88-94	ZE41-4298	-	M	
RVF400	94-96	ZE41-4298	-	M	
NC700S/X	12-16	ZE41-4298	-	M	
NC750S/X	14-16	ZE41-4298	-	M	
Y TZR250R/RS/RSR	90-95	ZE41-4299	-	M	
XJR400R/RII	01-07	ZE41-4299	-	M	
Ninja250SL	15-16	ZE41-4145	ZE41-3145	K	
Ninja250/300/R	08-17	ZE41-4145	ZE41-3145	K	
K Z250/300	13-16	ZE41-4145	ZE41-3145	K	
ZZR250	90-07	ZE41-4299	-	M	
ZZR400	90-06	ZE41-4299	-	M	
ZRX400/II	94-08	ZE41-4299	-	M	
ZEPHYR/X	89-06	ZE41-4299	-	M	
BALLUS/II	91-07	ZE41-4299	-	M	
S RGV250 GANMA	88-95				
GOOSE250/350	92-00	ZE41-4299	-	M	
Bandit250/400/V	89-00				
SV400/S	99-05				
INAZUMA400	97-01				
KTM DUKE125/200/250/390	11-16	ZE41-4286	ZE41-3286	M	
RC125/200/250/390	15-16				

Replacement parts



- Ti-color**
- Clutch Lever Arm K-Type**
ZE42-3100 3 Finger
ZE42-4100 4 Finger
 - Brake Lever Arm K-Type**
ZE41-3100 3 Finger
ZE41-4100 4 Finger
 - Clutch Lever Arm M-Type**
ZE42-3200 3 Finger
ZE42-4200 4 Finger
 - Brake Lever Arm M-Type**
ZE41-3200 3 Finger
ZE41-4200 4 Finger

- Black**
- Clutch Lever Arm K-Type**
ZE42-3100 3 Finger
ZE42-4100 4 Finger
 - Brake Lever Arm K-Type**
ZE41-3100 3 Finger
ZE41-4100 4 Finger
 - Brake Lever Arm M-Type**
ZE41-4200 4 Finger

- Mount Kit**
- ZE41-0190 Brake
 - ZE42-0190 Clutch

Bike	Year	Size	Gold	Ti-Color
HONDA				
GROM/MSX125	13-15	M24x30-P1.0 H18.2	ZS58-1104	ZS58-1108
VTR	99-14	M24x30-P1.0 H18.2	ZS58-1104	ZS58-1108
CBR250R	11-16	M24x30-P1.0 H18.2	ZS58-1104	ZS58-1108
CB250F	14-16	M24x30-P1.0 H18.2	ZS58-1104	ZS58-1108
CBR300R	15-16	M24x30-P1.0 H18.2	ZS58-1104	ZS58-1108
CB300F	15-16	M24x30-P1.0 H18.2	ZS58-1104	ZS58-1108
400X	13-15	M24x30-P1.0 H18.2	ZS58-1104	ZS58-1108
CB400F	13-15	M24x30-P1.0 H18.2	ZS58-1104	ZS58-1108
CBR400R	13-15	M24x30-P1.0 H18.2	ZS58-1104	ZS58-1108
CB400SF	92-16	M24x30-P1.0 H18.2	ZS58-1104	ZS58-1108
CB500F	13-16	M24x30-P1.0 H18.2	ZS58-1104	ZS58-1108
CB500X	13-16	M24x30-P1.0 H18.2	ZS58-1104	ZS58-1108
CBR500R	13-16	M24x30-P1.0 H18.2	ZS58-1104	ZS58-1108
CBR600RR	03-15	M24x30-P1.0 H18.2	ZS58-1104	ZS58-1108
CB650F	14-15	M24x30-P1.0 H18.2	ZS58-1104	ZS58-1108
CBR650F	14-16	M24x30-P1.0 H18.2	ZS58-1104	ZS58-1108
NC700S/X	12-16	M24x30-P1.0 H18.2	ZS58-1104	ZS58-1108
NC750S/X	14-15	M24x30-P1.0 H18.2	ZS58-1104	ZS58-1108
VFR800	98-09	M24x30-P1.0 H18.2	ZS58-1104	ZS58-1108
VFR800F/X	14-15	M24x30-P1.0 H18.2	ZS58-1104	ZS58-1108
CB1000R	11-15	M24x30-P1.0 H18.2	ZS58-1104	ZS58-1108
CBR1000RR	04-07	M24x30-P1.0 H18.2	ZS58-1104	ZS58-1108
CB1100	10-15	M24x30-P1.0 H18.2	ZS58-1104	ZS58-1108
VFR1200F	10-14	M24x30-P1.0 H18.2	ZS58-1104	ZS58-1108
VFR1200X	14-15	M24x30-P1.0 H18.2	ZS58-1104	ZS58-1108
CB1300SF	03-16	M24x30-P1.0 H18.2	ZS58-1104	ZS58-1108
YAMAHA				
FZ6/R	04-15	M22x27-P1.0 H18.5	ZS58-1404	ZS58-1408
YZF-R6	99-16	M28x36-P1.0 H17	ZS58-1304	ZS58-1308
FZ8	11-14	M28x36-P1.0 H17	ZS58-1304	ZS58-1308
FJ-09	14-16	M22x27-P1.0 H18.5	ZS58-1404	ZS58-1408
FZ-09	14-16	M22x27-P1.0 H18.5	ZS58-1404	ZS58-1408
MT-09/TRACER	14-16	M22x27-P1.0 H18.5	ZS58-1404	ZS58-1408
XSR900	16	M22x27-P1.0 H18.5	ZS58-1404	ZS58-1408
YZF-R1/M	98-16	M28x36-P1.0 H17	ZS58-1304	ZS58-1308
FZ1(North America)	01-05	M22x27-P1.0 H18.5	ZS58-1404	ZS58-1408
FZ1 FAZER(Japan)	06-15	M28x36-P1.0 H17	ZS58-1304	ZS58-1308
V-MAX	08-15	M28x36-P1.0 H17	ZS58-1304	ZS58-1308
XJR1300	99-07	M22x27-P1.0 H18.5	ZS58-1404	ZS58-1408
XJR1300	98-15	M22x27-P1.0 H18.5	ZS58-1404	ZS58-1408
KAWASAKI				
Ninja250/R	08-16	M16x22-P1.5 L=22	ZS58-1204	ZS58-1208
Z250	13-16	M16x22-P1.5 L=22	ZS58-1204	ZS58-1208
Ninja300	13-16	M16x22-P1.5 L=22	ZS58-1204	ZS58-1208
ER-4n	11-13	M26x30-P1.0 L=18	ZS58-1214	ZS58-1218
Ninja400/R	11-16	M26x30-P1.0 L=18	ZS58-1214	ZS58-1218
ZX-6R	05-12	M28x36-P1.0 H17	ZS58-1304	ZS58-1308
ZX-6R	13-16	M26x30-P1.0 L=18	ZS58-1214	ZS58-1218
ER-6f	07-10	M26x30-P1.0 L=18	ZS58-1214	ZS58-1218
ER-6n	06-14	M26x30-P1.0 L=18	ZS58-1214	ZS58-1218
Ninja650/R	06-16	M26x30-P1.0 L=18	ZS58-1214	ZS58-1218
Versys650	07-16	M26x30-P1.0 L=18	ZS58-1214	ZS58-1218
Ninja1000	11-16	M26x30-P1.0 L=18	ZS58-1214	ZS58-1218
Z750/S	04-10	M26x30-P1.0 L=18	ZS58-1214	ZS58-1218
Z800	13-16	M26x30-P1.0 L=18	ZS58-1214	ZS58-1218
Z1000	04-16	M26x30-P1.0 L=18	ZS58-1214	ZS58-1218
Z800	08-10	M26x30-P1.0 L=18	ZS58-1214	ZS58-1218
ZX-10R	11-15	M28x36-P1.0 H17	ZS58-1304	ZS58-1308
Versys1000	12-16	M26x30-P1.0 L=18	ZS58-1214	ZS58-1218
SUZUKI				
GSR250	12-15	M22x27-P1.0 H18.5	ZS58-1404	ZS58-1408
GSR250S	14-15	M22x27-P1.0 H18.5	ZS58-1404	ZS58-1408
GW250	12-15	M22x27-P1.0 H18.5	ZS58-1404	ZS58-1408
INAZUMA250	12-15	M22x27-P1.0 H18.5	ZS58-1404	ZS58-1408
GSX-R600	06-16	M28x36-P1.0 H17	ZS58-1304	ZS58-1308
GSR750	13-16	M22x27-P1.0 H18.5	ZS58-1404	ZS58-1408
GSX-R750	06-16	M28x36-P1.0 H17	ZS58-1304	ZS58-1308
GSX-R1000	06-16	M28x36-P1.0 H17	ZS58-1304	ZS58-1308

ZETA STEERING STEM NUT & BOLT

- CNC Machined steering stem nut and bolt.
- Made of A7009-T6 aluminum, light weight design.
- Available in Gold and Titanium color anodized colors.

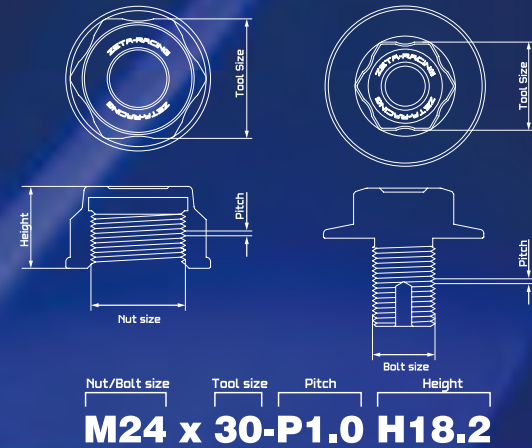

CONTROL



LEVER



BODY



ELECTRICAL



ZS89-5048 CBR250R

ZETA REAR BRAKE CLEVIS

- Made of CNC machined aluminum with anodized finish.
- Durable yet lightweight design provides the sensitive rear brake feel.
- Available in gold and titanium colors.
- Stainless steel pin is resistant to rust.

	Bike	Year	Gold	Ti-color
H	CB250F	14-16	ZS89-5044	ZS89-5048
	CB300F	15-16	ZS89-5044	ZS89-5048
	CBR250R	11-16	ZS89-5044	ZS89-5048
	CBR300R	15	ZS89-5044	ZS89-5048
	400X	13-15	ZS89-5044	ZS89-5048
	CB400F	13-15	ZS89-5044	ZS89-5048
	CB400SF	08-16	ZS89-5044	ZS89-5048
	CBR400R	13-15	ZS89-5044	ZS89-5048
	CB500F/X	13-16	ZS89-5044	ZS89-5048
	CBR500R	13-16	ZS89-5044	ZS89-5048
Y	MT-25/03	16	ZS89-5034	ZS89-5038
	YZF-R25/R3	15-16	ZS89-5034	ZS89-5038
K	Ninja 250/R	08-16	ZS89-5034	ZS89-5038
	Z250	13-16	ZS89-5034	ZS89-5038
	Ninja 300	13-16	ZS89-5034	ZS89-5038
	ER-4n	11-13	ZS89-5034	ZS89-5038
	Ninja 400R	11-13	ZS89-5034	ZS89-5038
	ER-6n	09-11	ZS89-5034	ZS89-5038
Ninja 650R	09-11	ZS89-5034	ZS89-5038	

CONTROL

LEVER

BODY

ELECTRICAL



ZS86-0138

ZS86-0124

ZS86-0158

ZS86-0114

ZS86-0418

ZS86-0424



FZ09/MT09/Tracer ZS86-0168

Ninja 250 ZS86-0424

ZETA
MASTER CYLINDER COVER

- Made of CNC machined aluminum with anodized finish.
- Makes your cylinder cover look exclusive.
- Available in gold and titanium colors.
- Available for front and rear brake cylinder cover and clutch cylinder cover.

	Master Cylinder Cover Clutch			
	Bike	Year	Gold	Ti-color
HONDA	VFR800	98-09	ZS86-0124	ZS86-0128
	VFR800F	14-15	ZS86-0124	ZS86-0128
	CB1000	94-95	ZS86-0124	ZS86-0128
	CB1000R	11-14	ZS86-0424	ZS86-0428
	CBR1000F	87-96	ZS86-0124	ZS86-0128
	CBR1000RR	04-07	ZS86-0424	ZS86-0428
	RVT1000R	00-06	ZS86-0424	ZS86-0428
	CB1100	10-15	ZS86-0124	ZS86-0128
	CBR1100XX	97-03	ZS86-0124	ZS86-0128
	ST1100	91-03	ZS86-0124	ZS86-0128
	CB1300SF	98-16	ZS86-0124	ZS86-0128
	ST1300	03-13	ZS86-0124	ZS86-0128
	X-4	97-03	ZS86-0124	ZS86-0128
	YAMAHA	XJR1200	94-96	ZS86-0144
FJR1300		03-15	ZS86-0144	ZS86-0148
XJR1300		98-15	ZS86-0144	ZS86-0148
KAWASAKI	XJR1300C	15	ZS86-0144	ZS86-0148
	ZX-9R	94-97	ZS86-0144	ZS86-0148
	GPZ1100	95-07	ZS86-0144	ZS86-0148
	ZEPHYR1100	92-05	ZS86-0144	ZS86-0148
	ZEPHYR1100RS	96-02	ZS86-0144	ZS86-0148
	ZR1100	92-95	ZS86-0144	ZS86-0148
	ZRX1100	99-00	ZS86-0144	ZS86-0148
	ZX-11	92-01	ZS86-0144	ZS86-0148
	ZRX1200DAEG	09-16	ZS86-0144	ZS86-0148
	ZRX1200R	01-05	ZS86-0144	ZS86-0148
	ZRX1200S	01-04	ZS86-0144	ZS86-0148
	ZZR1200S	02-05	ZS86-0144	ZS86-0148
	GS650F	08-09	ZS86-0154	ZS86-0158
	GSX-R1000	07-08	ZS86-0424	ZS86-0428
SV1000	03-05	ZS86-0154	ZS86-0158	
SV1000S	03-07	ZS86-0424	ZS86-0428	
TL1000R	98-03	ZS86-0424	ZS86-0428	
V-Strom1000	02-15	ZS86-0154	ZS86-0158	
GSX-R1100	91-92	ZS86-0154	ZS86-0158	
GSX-R1100W	93-98	ZS86-0154	ZS86-0158	
BANDIT1200	97-05	ZS86-0154	ZS86-0158	
BANDIT1250/S	07-15	ZS86-0154	ZS86-0158	
GSX1250F	11	ZS86-0154	ZS86-0158	
GSX1300R	99-16	ZS86-0154	ZS86-0158	
Hayabusa				

	Master Cylinder Cover Front			
	Bike	Year	Gold	Ti-color
ADZOX	GROM/MSX125	13-15	ZS86-0114	ZS86-0118
	PCX150	13-15	ZS86-0114	ZS86-0118
	HORNET250	96-06	ZS86-0114	ZS86-0118
	VTR/VTR-F	98-15	ZS86-0114	ZS86-0118
	CB250F	14-16	ZS86-0114	ZS86-0118
	CB300F	15-16	ZS86-0114	ZS86-0118
	CBR250R	11-16	ZS86-0114	ZS86-0118
	CBR300R	15-16	ZS86-0114	ZS86-0118
	400X	13-15	ZS86-0114	ZS86-0118
	CB400F	89-90	ZS86-0124	ZS86-0128
	CBR400R	92-16	ZS86-0124	ZS86-0128
	CB400SF	13-15	ZS86-0114	ZS86-0118
	CB500X/F	13-16	ZS86-0114	ZS86-0118
	CBR500R	13-16	ZS86-0114	ZS86-0118
CB600F	04-06	ZS86-0124	ZS86-0128	
CBR600F	91-06	ZS86-0124	ZS86-0128	
CBR600RR	03-06	ZS86-0124	ZS86-0128	
CB650F	14-16	ZS86-0124	ZS86-0128	
CBR650F	14-16	ZS86-0124	ZS86-0128	
NC700X/S	12-16	ZS86-0124	ZS86-0128	
NT700V	10-11	ZS86-0124	ZS86-0128	
CB750	04-08	ZS86-0124	ZS86-0128	
NC750X/S	14	ZS86-0124	ZS86-0128	
VFR800F	98-09	ZS86-0124	ZS86-0128	
VFR800F	14-15	ZS86-0124	ZS86-0128	
CB900F	02-07	ZS86-0124	ZS86-0128	
CB1000	94-95	ZS86-0124	ZS86-0128	
CB1000R	11-14	ZS86-0124	ZS86-0128	
CBR1000F	87-96	ZS86-0124	ZS86-0128	
CBR1000S	14-16	ZS86-0124	ZS86-0128	
CBR1000RR	06-16	ZS86-0124	ZS86-0128	
CB1100	10-15	ZS86-0124	ZS86-0128	
CBR1000XX	97-03	ZS86-0124	ZS86-0128	
ST1100	91-03	ZS86-0124	ZS86-0128	
VFR1200X	14	ZS86-0124	ZS86-0128	
CB1300SF	98-16	ZS86-0124	ZS86-0128	
ST1300	03-13	ZS86-0124	ZS86-0128	
X-4	97-03	ZS86-0124	ZS86-0128	
KUZUS	GSR250	12-15	ZS86-0154	ZS86-0158
	GSX-R250S	14-15	ZS86-0154	ZS86-0158
	GW250	12-15	ZS86-0154	ZS86-0158
	INAZUMA250	12-15	ZS86-0154	ZS86-0158
	BANDIT400	91-93	ZS86-0154	ZS86-0158
	GLADIUS400	10-13	ZS86-0154	ZS86-0158
	GSR400	06-13	ZS86-0154	ZS86-0158
	GSX-R600	97-16	ZS86-0144	ZS86-0148
	GSX-R600W	92-93	ZS86-0144	ZS86-0148
	GS650F	08-09	ZS86-0154	ZS86-0158
	SV650	99-09	ZS86-0154	ZS86-0158
	SV650S	99-09	ZS86-0154	ZS86-0158
	V-Strom650	04-15	ZS86-0154	ZS86-0158
	GLADIUS650	09	ZS86-0154	ZS86-0158
GSX-R750	13-15	ZS86-0154	ZS86-0158	
GSX-R750	93-16	ZS86-0144	ZS86-0148	
GSX750F	89-06	ZS86-0154	ZS86-0158	
GSX-R1000	01-16	ZS86-0144	ZS86-0148	
SV1000	03-05	ZS86-0154	ZS86-0158	
SV1000S	03-07	ZS86-0154	ZS86-0158	
TL1000R	98-03	ZS86-0144	ZS86-0148	
TL1000S	97-01	ZS86-0144	ZS86-0148	
V-Strom1000	02-15	ZS86-0154	ZS86-0158	
GSX-R1100	91-92	ZS86-0154	ZS86-0158	
GSX-R1100W	93-98	ZS86-0154	ZS86-0158	
BANDIT1200	97-05	ZS86-0154	ZS86-0158	
BANDIT1250/S	07-15	ZS86-0154	ZS86-0158	
GSX1250F	11	ZS86-0154	ZS86-0158	
GSX1300R	99-16	ZS86-0154	ZS86-0158	
Hayabusa				

	Master Cylinder Cover Front			
	Bike	Year	Gold	Ti-color
YAMAHA	FZ6/R	04-15	ZS86-0164	ZS86-0168
	R6S	06-09	ZS86-0414	ZS86-0418
	YZF-R6	99-16	ZS86-0144	ZS86-0148
	FZ-07	15-16	ZS86-0164	ZS86-0168
	MT-07	14-16	ZS86-0164	ZS86-0168
	FZ-09	14-16	ZS86-0164	ZS86-0168
	MT-09/TRACER	14-16	ZS86-0164	ZS86-0168
	FZ1	01-05	ZS86-0144	ZS86-0148
	MT-05	06-15	ZS86-0144	ZS86-0148
	FZ1 Fazer	08-15	ZS86-0164	ZS86-0168
	YZF-R1	98-16	ZS86-0144	ZS86-0148
	XJR1200	94-96	ZS86-0144	ZS86-0148
	FJR1300	03	ZS86-0144	ZS86-0148
	XJR1300	04-15	ZS86-0164	ZS86-0168
XJR1300C	98-15	ZS86-0144	ZS86-0148	
KAWASAKI	XJR1300C	15	ZS86-0144	ZS86-0148
	Ninja 250R	92-07	ZS86-0144	ZS86-0148
	Ninja 250/R	08-16	ZS86-0114	ZS86-0118
	Ninja 250SL	15	ZS86-0114	ZS86-0118
	Z250	13-16	ZS86-0114	ZS86-0118
	Ninja 300	13-16	ZS86-0114	ZS86-0118
	ER-4n	11-13	ZS86-0134	ZS86-0138
	Ninja 400/R	11-16	ZS86-0134	ZS86-0138
	ZRX	94-08	ZS86-0144	ZS86-0148
	ZRX-ii	95-06	ZS86-0144	ZS86-0148
	ZZR400	93-06	ZS86-0144	ZS86-0148
	Ninja 500	94-09	ZS86-0144	ZS86-0148
	ZEPHYR ZR550	92-08	ZS86-0144	ZS86-0148
	Ninja 600R	92-97	ZS86-0144	ZS86-0148
ZX-6	92-01	ZS86-0144	ZS86-0148	
ZX-6R	95-97	ZS86-0144	ZS86-0148	
ZX-6RR	98-16	ZS86-0144	ZS86-0148	
ZZR600	02-04	ZS86-0144	ZS86-0148	
ER-6f	05-08	ZS86-0144	ZS86-0148	
ER-6n	09-10	ZS86-0144	ZS86-0148	
ER-6n	09-14	ZS86-0134	ZS86-0138	
Ninja 650/R	09-16	ZS86-0134	ZS86-0138	
Ninja 650R	06-08	ZS86-0144	ZS86-0148	
07-08	ZS86-0144	ZS86-0148		
Versys	09-14	ZS86-0134	ZS86-0138	
Versys650	15-16	ZS86-0134	ZS86-0138	
KAWASAKI	Z750	04-05	ZS86-0144	ZS86-0148
	Z750	06-10	ZS86-0144	ZS86-0148
	Z750S	05-07	ZS86-0144	ZS86-0148
	ZR-7	00	ZS86-0144	ZS86-0148
	ZR750	92-93	ZS86-0144	ZS86-0148
	ZR-7S	01-05	ZS86-0144	ZS86-0148
	ZX-7R	91-03	ZS86-0144	ZS86-0148
	ZX-7RR	96-97	ZS86-0144	ZS86-0148
	ZX-9R	94-97	ZS86-0144	ZS86-0148
	98-03	ZS86-0144	ZS86-0148	
	Ninja 1000	11-16	ZS86-0144	ZS86-0148
	Versys1000	12-14	ZS86-0144	ZS86-0148
	15-16	ZS86-0134	ZS86-0138	
	Z1000	03-06	ZS86-0144	ZS86-0148
07-09	ZS86-0144	ZS86-0148		
ZX-10R	04-15	ZS86-0144	ZS86-0148	
GPZ1100	95-07	ZS86-0144	ZS86-0148	
ZEPHYR1100	92-05	ZS86-0144	ZS86-0148	
ZEPHYR1100RS	96-02	ZS86-0144	ZS86-0148	
ZR1100	92-95	ZS86-0144	ZS86-0148	
ZRX1100	99-00	ZS86-0144	ZS86-0148	
ZX-11	92-01	ZS86-0144	ZS86-0148	
ZRX1200DAEG	09-16	ZS86-0144	ZS86-0148	
ZRX1200R	01-05	ZS86-0144	ZS86-0148	
ZRX1200S	01-04	ZS86-0144	ZS86-0148	
ZX-12R	00-05	ZS86-0144	ZS86-0148	
ZZR1200	02-05	ZS86-0144	ZS86-0148	
ZX-14	06-11	ZS86-0144	ZS86-0148	
ZX-14R	12-16	ZS86-0144	ZS86-0148	
ZZR1400	06-11	ZS86-0144	ZS86-0148	

	Master Cylinder Cover Rear			
	Bike	Year	Gold	Ti-color
ADZOX	HORNET250	96-06	ZS86-0414	ZS86-0418
	VTR/VTR-F	98-15	ZS86-0414	ZS86-0418
	400X	13-15	ZS86-0114	ZS86-0118
	CB400F	89-90	ZS86-0114	ZS86-0118
	CB400SF	13-15	ZS86-0114	ZS86-0118
	CBR400R	13-15	ZS86-0114	ZS86-0118
	CB500FIX	13-16	ZS86-0114	ZS86-0118
	CBR500R	13-16	ZS86-0114	ZS86-0118
	CB600F	04-06	ZS86-0144	ZS86-0148
	CBR600F	91-06	ZS86-0144	ZS86-0148
	CBR600RR	03-16	ZS86-0114	ZS86-0118
	CB650F	14-16	ZS86-0114	ZS86-0118
	CBR650F	14-16		

Engine Plugs						
	Bike		Year	Gold	Ti-color	Qty
	H	GROM		13-15	ZS89-1104	ZS89-1108
MSX125			13-15	ZS89-1104	ZS89-1108	2
VTR/VTR-F			09-15	ZS89-1114	ZS89-1118	1
CB250F			14-16	ZS89-1104	ZS89-1108	2
CB300F			15-16	ZS89-1104	ZS89-1108	2
CBR250R			11-16	ZS89-1104	ZS89-1108	2
CBR300R			15	ZS89-1104	ZS89-1108	2
CB400SF REVO			08-16	ZS89-1104	ZS89-1108	2
CB400F/CBR400R/400X			13-15	ZS89-1114	ZS89-1118	1
CB500F/CBR500R/CB500X			13-16	ZS89-1114	ZS89-1118	1
CBR600RR			03-15	ZS89-1114	ZS89-1118	1
CB650F			14-15	ZS89-1114	ZS89-1118	1
CBR650F			14-16	ZS89-1114	ZS89-1118	1
NC700X/S			12-16	ZS89-1104	ZS89-1108	2
NC750X/S			14-15	ZS89-1104	ZS89-1108	2
CBR1000RR			04-16	ZS89-1114	ZS89-1118	1
CBR1000S			14-16	ZS89-1114	ZS89-1118	1
CB1300SF			98-16	ZS89-1104	ZS89-1108	2
Y	MT-25		16	ZS89-1404	ZS89-1408	1
	MT-03		16	ZS89-1404	ZS89-1408	1
	YZF-R25		15-16	ZS89-1404	ZS89-1408	1
	YZF-R3		15-16	ZS89-1404	ZS89-1408	1
	FZ-07		15-16	ZS89-1414	ZS89-1418	1
	MT-07		14-16	ZS89-1414	ZS89-1418	1
	FZ-09		14-16	ZS89-1414	ZS89-1418	1
	MT-09/TRACER		14-16	ZS89-1414	ZS89-1418	1
	Ninja 250		13-16	ZS89-1214	ZS89-1218	1
K	Z250		13-15	ZS89-1214	ZS89-1218	1
	Ninja 300		13-16	ZS89-1214	ZS89-1218	1
	ER-4n		11-13	ZS89-1204	ZS89-1208	2
	Ninja 400		14-16	ZS89-1204	ZS89-1208	2
	ER-6f		12-13	ZS89-1204	ZS89-1208	2
	ER-6n		09-14	ZS89-1204	ZS89-1208	2
	Ninja 650		12-16	ZS89-1204	ZS89-1208	2
	Versis		11-14	ZS89-1204	ZS89-1208	2
	Versis650		15-16	ZS89-1204	ZS89-1208	2
	GSXR250		12-15	ZS89-1304	ZS89-1308	1
S	GSXR250S		14-15	ZS89-1304	ZS89-1308	1
	GW250		12-15	ZS89-1304	ZS89-1308	1
	INAZUMA 250		12-15	ZS89-1304	ZS89-1308	1

ZETA ENGINE PLUG

- Made of CNC machined aluminum with anodized finish.
- Ideal for dressing up your engine.
- Available in gold and titanium colors.
- # Please use stock o-ring.

CONTROL



LEVER



BODY



ELECTRICAL



Oil Filler Cap					
	Bike		Year	Gold	Ti-color
	H	CB250F		14-16	ZS89-2104
CB300F			15-16	ZS89-2104	ZS89-2108
CBR250R			11-16	ZS89-2104	ZS89-2108
CBR300R			15-16	ZS89-2104	ZS89-2108
400X			13-15	ZS89-2104	ZS89-2108
CB400F			13-15	ZS89-2104	ZS89-2108
CB400SF			99-16	ZS89-2104	ZS89-2108
CBR400R			13-15	ZS89-2104	ZS89-2108
CB500X			13-16	ZS89-2104	ZS89-2108
CB500F			13-16	ZS89-2104	ZS89-2108
CBR500R			13-16	ZS89-2104	ZS89-2108
CBR600RR			03-16	ZS89-2104	ZS89-2108
CBR929RR			00-01	ZS89-2104	ZS89-2108
CBR954RR			02-03	ZS89-2104	ZS89-2108
CB1100			10-15	ZS89-2104	ZS89-2108
CBR1000RR			04-16	ZS89-2104	ZS89-2108
CBR1000S			14-16	ZS89-2104	ZS89-2108
VFR1000F			98-05	ZS89-2104	ZS89-2108
VFR1200F		10-12	ZS89-2104	ZS89-2108	
VFR1200X		14-15	ZS89-2104	ZS89-2108	
X-4		97-03	ZS89-2104	ZS89-2108	
K	Ninja 250		13-16	ZS89-2204	ZS89-2208
	Ninja 250R		08-12	ZS89-2204	ZS89-2208
	Z250		13-15	ZS89-2204	ZS89-2208
	ZZR250		90-07	ZS89-2204	ZS89-2208
	Ninja 300		13-16	ZS89-2204	ZS89-2208
	ER-4n		11-13	ZS89-2104	ZS89-2108
	EX-4		94-95	ZS89-2204	ZS89-2208
	FX400R		86-90	ZS89-2204	ZS89-2208
	GPZ400R/S		83-88	ZS89-2204	ZS89-2208
	Ninja 400		14-16	ZS89-2104	ZS89-2108
	Ninja 400R		11-13	ZS89-2104	ZS89-2108
	ZEPHYR400 KAI		96-07	ZS89-2204	ZS89-2208
	ZXR400R		89-99	ZS89-2204	ZS89-2208
	ZZR400		90-06	ZS89-2204	ZS89-2208
	ER-6f		06-10	ZS89-2104	ZS89-2108
	ER-6n		06-14	ZS89-2104	ZS89-2108
	Ninja 600R		09-11	ZS89-2104	ZS89-2108
	Ninja 650		12-16	ZS89-2104	ZS89-2108
Versys		11-14	ZS89-2104	ZS89-2108	
Versys650		15-16	ZS89-2104	ZS89-2108	
ZX-6R		00-16	ZS89-2204	ZS89-2208	
ZX-6RR		03-05	ZS89-2204	ZS89-2208	
Z750/S		04-10	ZS89-2204	ZS89-2208	
Z750/S		04-10	ZS89-2204	ZS89-2208	
ZR-7		99-01	ZS89-2204	ZS89-2208	
ZXR750		89-95	ZS89-2104	ZS89-2108	
ZXR750R		91-94	ZS89-2104	ZS89-2108	
Z800		13-16	ZS89-2104	ZS89-2108	
GPZ900R		91-03	ZS89-2204	ZS89-2208	
ZX-9R		98-03	ZS89-2204	ZS89-2208	
GPZ1100		95-99	ZS89-2204	ZS89-2208	
Ninja 1000		10-16	ZS89-2104	ZS89-2108	
Versys1000		12-16	ZS89-2104	ZS89-2108	
Z1000		10-16	ZS89-2104	ZS89-2108	
Z1000		03-09	ZS89-2204	ZS89-2208	
ZX-10R		04-16	ZS89-2204	ZS89-2208	
ZRX1100/II		97-00	ZS89-2204	ZS89-2208	
ZZ-R1100		99-01	ZS89-2204	ZS89-2208	
ZRX1200R/S/DAEG		01-16	ZS89-2204	ZS89-2208	
ZX-12R		00-06	ZS89-2204	ZS89-2208	
ZZR1200		02-05	ZS89-2204	ZS89-2208	
ZX-14R		12-16	ZS89-2204	ZS89-2208	
ZZR1400		06-11	ZS89-2204	ZS89-2208	
1400GTR		08-16	ZS89-2204	ZS89-2208	

Oil Filler Cap					
	Bike		Year	Gold	Ti-color
	Y	FZR250/R		87-94	ZS89-2404
FXZ250 ZEAL			91-92	ZS89-2404	ZS89-2408
MT-25			16	ZS89-2404	ZS89-2408
MT-03			16	ZS89-2404	ZS89-2408
YZF-R25			15-16	ZS89-2404	ZS89-2408
YZF-R3			15-16	ZS89-2404	ZS89-2408
FZ400			97	ZS89-2404	ZS89-2408
XJR400			93-96	ZS89-2404	ZS89-2408
FZ6/Fazer			04-06	ZS89-2404	ZS89-2408
FZS600/S Fazer			00-03	ZS89-2404	ZS89-2408
FZX750			90	ZS89-2404	ZS89-2408
FZ6R			09-15	ZS89-2404	ZS89-2408
YZF-R6			99-16	ZS89-2404	ZS89-2408
MT-07			14-16	ZS89-2404	ZS89-2408
FZ-07			15-16	ZS89-2404	ZS89-2408
FZ8			11-13	ZS89-2404	ZS89-2408
TDM850			98-01	ZS89-2404	ZS89-2408
XJ900			00-02	ZS89-2404	ZS89-2408
DIVERSION		00-02	ZS89-2404	ZS89-2408	
FZ-1		06-15	ZS89-2404	ZS89-2408	
FZ-1FAZER		06-15	ZS89-2404	ZS89-2408	
FZS1000FAZER		01-05	ZS89-2404	ZS89-2408	
YZF-R1		98-14	ZS89-2404	ZS89-2408	
XJR1200		94-96	ZS89-2404	ZS89-2408	
FJR1300		01-15	ZS89-2404	ZS89-2408	
XVS1300A		99-09	ZS89-2404	ZS89-2408	
S	GSXR250		12-15	ZS89-2304	ZS89-2308
	GSXR250S		14-15	ZS89-2304	ZS89-2308
	GW250		12-15	ZS89-2304	ZS89-2308
	INAZUMA 250		12-15	ZS89-2304	ZS89-2308
	GSXR400		06-12	ZS89-2304	ZS89-2308
	GLADIUS 400		09-13	ZS89-2304	ZS89-2308
	IMPULSUS 400		94-07	ZS89-2304	ZS89-2308
	INAZUMA 400		97-02	ZS89-2304	ZS89-2308
	GSX-R600		97-16	ZS89-2304	ZS89-2308
	V-STORM650		04-15	ZS89-2304	ZS89-2308
	GSF750		96-00	ZS89-2304	ZS89-2308
	GSXR750		13-15	ZS89-2304	ZS89-2308
	GSX-R750		89-16	ZS89-2304	ZS89-2308
	GSX-R1000		01-16	ZS89-2304	ZS89-2308
	GSX-S1000/F		15-16	ZS89-2304	ZS89-2308
	SV1000/S		03-07	ZS89-2304	ZS89-2308
	V-Storm1000		04-15	ZS89-2304	ZS89-2308
	GSX-R1100/W		86-98	ZS89-2304	ZS89-2308
BANDIT1200/S		01-06	ZS89-2304	ZS89-2308	
BANDIT1250/S/F		06-15	ZS89-2304	ZS89-2308	
GS1200SS		01-02	ZS89-2304	ZS89-2308	
GSF1200		01-06	ZS89-2304	ZS89-2308	
GSF1250		08-09	ZS89-2304	ZS89-2308	
GSX1300R		08-16	ZS89-2304	ZS89-2308	
Hayabusa		08	ZS89-2304	ZS89-2308	
B-KING		08	ZS89-2304	ZS89-2308	
GSX1400		01-08	ZS89-2304	ZS89-2308	

ZETA OIL FILLER CAP

- Made of CNC machined aluminum with anodized finish.
- 19mm hex wrench head.
- Equipped with wiring hole to prevent losing the part.
- Available in gold and titanium colors.
- # Please use stock o-ring.

YZF-R25 ZS89-2404



ZS80-9110

ZS80-9100

ZETA DRIVE COVER

- Made of CNC machined aluminum with anodized finish.
- Easy maintenance.
- Available in titanium color.
- Made of A7009-T6 aluminum.

Drive Cover			
	Bike	Year	Ti-color
HONDA	CBR250R	11-16	ZS80-9100
	CBR300R	15	ZS80-9100
	CB250F	14-16	ZS80-9100
	CB300F	15-16	ZS80-9100
	CB400SF REVO	08-16	ZS80-9110
KAWASAKI	Ninja 250	13-16	ZS80-9200
	Z250	13-16	ZS80-9200
	Ninja 300	13-16	ZS80-9200



Ninja 250 ZS80-9200

CONTROL



LEVER



BODY



ELECTRICAL



YZF-R25

ZS56-2208



Ninja 250

ZS56-2408

ZS56-2108

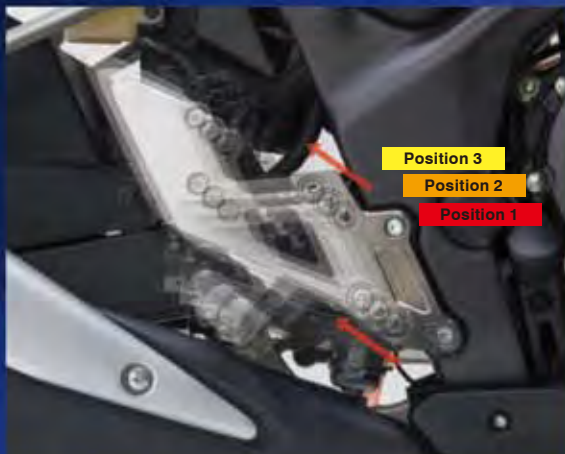

ZETA STEP BRACKET KIT

- Adjust the stock rear set back for a better riding position and more ground clearance.
- 3 different position adjustments to fit your riding position.
- Made of CNC titanium anodized aluminum, comes with stainless gear change rod and nuts.

Step Bracket Kit				Offset (mm)					
Bike	Year	Part #	Position 1		Position 2		Position 3		
			Back	Up	Back	Up	Back	Up	
HONDA	CBR250R	11-13	ZS56-2108	33	10	43	20	53	30
	MT-25	16		28	3	38	10	-	-
YAMAHA	MT-03	16	ZS56-2408	28	3	38	10	-	-
	YZF-R25	15-16		28	3	38	10	-	-
	YZF-R3	15-16		28	3	38	10	-	-
KAWASAKI	Ninja250R	08-12		21	5	26	18	31	32
	Ninja250	13-17	ZS56-2208	21	5	26	18	31	32
	Ninja300	13-16		21	5	26	18	31	32
	Z250	13-16		21	5	26	18	31	32



Magnetic Drain Bolt		Year	Size	Blue	Red
YAMAHA	FZR250/R	87-94	M14X14-P1.5	ZE58-1622	ZE58-1623
	MT-25	16	M12X15-P1.5	ZE58-1522	ZE58-1523
	MT-03	16	M12X15-P1.5	ZE58-1522	ZE58-1523
	YZF-R25	15-16	M12X15-P1.5	ZE58-1522	ZE58-1523
	YZF-R3	15-16	M12X15-P1.5	ZE58-1522	ZE58-1523
	ZEAL	91-99	M14X14-P1.5	ZE58-1622	ZE58-1623
	FZ400	97	M14X14-P1.5	ZE58-1622	ZE58-1623
	FZR400RR	90-94	M14X14-P1.5	ZE58-1622	ZE58-1623
	SRX400	85-99	M14X14-P1.5	ZE58-1622	ZE58-1623
	XJR400/R/S	93-08	M14X14-P1.5	ZE58-1622	ZE58-1623
	FZ6/R	04-15	M14X14-P1.5	ZE58-1622	ZE58-1623
	SRX600	85-94	M14X14-P1.5	ZE58-1622	ZE58-1623
	YZF-R6	99-16	M14X14-P1.5	ZE58-1622	ZE58-1623
	XJ6F/S	09-13	M14X14-P1.5	ZE58-1622	ZE58-1623
	FZ-07	15-16	M14X14-P1.5	ZE58-1622	ZE58-1623
	MT-07	14-16	M14X14-P1.5	ZE58-1622	ZE58-1623
	FZ8	11-14	M14X14-P1.5	ZE58-1622	ZE58-1623
	TDM850	92-01	M14X14-P1.5	ZE58-1622	ZE58-1623
	TRX850	95-01	M14X14-P1.5	ZE58-1622	ZE58-1623
	KAWASAKI	FZ-09/FJ-09	14-16	M14X14-P1.5	ZE58-1622
MT-09/TRACER		14-16	M14X14-P1.5	ZE58-1622	ZE58-1623
FZ1-N (JAPAN)		08-12	M14X14-P1.5	ZE58-1622	ZE58-1623
FZ1 FAZER		08-15	M14X14-P1.5	ZE58-1622	ZE58-1623
FZ1(North America)		01-15	M14X14-P1.5	ZE58-1622	ZE58-1623
YZF1000R THUNDERACE		96-01	M14X14-P1.5	ZE58-1622	ZE58-1623
YZF-R1		98-14	M14X14-P1.5	ZE58-1622	ZE58-1623
XJR1200		94-96	M14X14-P1.5	ZE58-1622	ZE58-1623
FJR1300		01-15	M14X14-P1.5	ZE58-1622	ZE58-1623
XJR1300		98-15	M14X14-P1.5	ZE58-1622	ZE58-1623
V-MAX		90-07	M14X14-P1.5	ZE58-1622	ZE58-1623
		09-16	M14X14-P1.5	ZE58-1622	ZE58-1623
BALIUS/II		91-07	M12X15-P1.5	ZE58-1522	ZE58-1523
NINJA250		13-16	M12X15-P1.5	ZE58-1522	ZE58-1523
NINJA250R		88-12	M12X15-P1.5	ZE58-1522	ZE58-1523
NINJA250SL		15	M10X15-P1.5	ZE58-1322	ZE58-1323
Z250		13-16	M12X15-P1.5	ZE58-1522	ZE58-1523
ZXR250		89-99	M12X15-P1.5	ZE58-1522	ZE58-1523
ZZR250		90-07	M12X15-P1.5	ZE58-1522	ZE58-1523
NINJA300		13-16	M12X15-P1.5	ZE58-1522	ZE58-1523
ER-4N	11-13	M12X15-P1.5	ZE58-1522	ZE58-1523	
NINJA400	14-16	M12X15-P1.5	ZE58-1522	ZE58-1523	
NINJA400R	11-13	M12X15-P1.5	ZE58-1522	ZE58-1523	
W400	06-08	M12X15-P1.5	ZE58-1522	ZE58-1523	
ZEPHYR400/KAJ	89-08	M12X15-P1.5	ZE58-1522	ZE58-1523	
ZRX400	94-08	M12X15-P1.5	ZE58-1522	ZE58-1523	
ZXR400	89-01	M12X15-P1.5	ZE58-1522	ZE58-1523	
ZZR400	90-07	M12X15-P1.5	ZE58-1522	ZE58-1523	
NINJA 500	94-09	M12X15-P1.5	ZE58-1522	ZE58-1523	
ZR500	90-93	M12X15-P1.5	ZE58-1522	ZE58-1523	
NINJA 600R	88-97	M12X15-P1.5	ZE58-1522	ZE58-1523	
ZX-6R/R	91-16	M12X15-P1.5	ZE58-1522	ZE58-1523	
ZZR600	02-08	M12X15-P1.5	ZE58-1522	ZE58-1523	
ER-6F	09-10	M12X15-P1.5	ZE58-1522	ZE58-1523	
ER-6N	09-14	M12X15-P1.5	ZE58-1522	ZE58-1523	
NINJA 650/R	09-16	M12X15-P1.5	ZE58-1522	ZE58-1523	
VERSYS 650	10-16	M12X15-P1.5	ZE58-1522	ZE58-1523	
W650	99-08	M12X15-P1.5	ZE58-1522	ZE58-1523	
NINJA 750R	87-90	M12X15-P1.5	ZE58-1522	ZE58-1523	
ZR-7/S	00-05	M12X15-P1.5	ZE58-1522	ZE58-1523	
ZX-7R/RR	89-03	M12X15-P1.5	ZE58-1522	ZE58-1523	
Z750/S	04-10	M12X15-P1.5	ZE58-1522	ZE58-1523	
ZEPHYR750/RS	91-06	M12X15-P1.5	ZE58-1522	ZE58-1523	
ZR750	91-93	M12X15-P1.5	ZE58-1522	ZE58-1523	
ZXR750	89-95	M12X15-P1.5	ZE58-1522	ZE58-1523	
Z800	13-16	M12X15-P1.5	ZE58-1522	ZE58-1523	
ZX-9R	94-03	M12X15-P1.5	ZE58-1522	ZE58-1523	
NINJA 1000	11-16	M12X15-P1.5	ZE58-1522	ZE58-1523	
VERSYS1000	12-16	M12X15-P1.5	ZE58-1522	ZE58-1523	
Z1000	03-16	M12X15-P1.5	ZE58-1522	ZE58-1523	
ZX-10	88-90	M12X15-P1.5	ZE58-1522	ZE58-1523	
ZX-10R	04-16	M12X15-P1.5	ZE58-1522	ZE58-1523	
GPZ1100	95-99	M12X15-P1.5	ZE58-1522	ZE58-1523	
ZEPHYR1100/RS	92-06	M12X15-P1.5	ZE58-1522	ZE58-1523	
ZR1100	92-95	M12X15-P1.5	ZE58-1522	ZE58-1523	
ZRX1100	97-00	M12X15-P1.5	ZE58-1522	ZE58-1523	
ZX-11	90-01	M12X15-P1.5	ZE58-1522	ZE58-1523	
ZZR1100	90-01	M12X15-P1.5	ZE58-1522	ZE58-1523	
ZX-12R	00-06	M12X15-P1.5	ZE58-1522	ZE58-1523	
ZRX1200DAEG	09-16	M12X15-P1.5	ZE58-1522	ZE58-1523	
ZRX1200R/S	01-08	M12X15-P1.5	ZE58-1522	ZE58-1523	
ZZR1200	02-05	M12X15-P1.5	ZE58-1522	ZE58-1523	
ZX-14	06-11	M12X15-P1.5	ZE58-1522	ZE58-1523	
ZX-14R	12-16	M12X15-P1.5	ZE58-1522	ZE58-1523	
SUZUKI	BANDIT250/V	90-00	M14X10-P1.25	ZE58-1612	ZE58-1613
	GSR250	11-15	M14X10-P1.25	ZE58-1612	ZE58-1613
	GSR250S	14-15	M14X10-P1.25	ZE58-1612	ZE58-1613
	GW250	11-15	M14X10-P1.25	ZE58-1612	ZE58-1613
	INAZUMA250	11-15	M14X10-P1.25	ZE58-1612	ZE58-1613
	GSX250S	91-99	M14X10-P1.25	ZE58-1612	ZE58-1613
	GSR400	06-14	M14X10-P1.25	ZE58-1612	ZE58-1613
	GSX400S	92-99	M14X10-P1.25	ZE58-1612	ZE58-1613
	GSX400	94-00	M14X10-P1.25	ZE58-1612	ZE58-1613
	INAZUMA400	97-02	M14X10-P1.25	ZE58-1612	ZE58-1613
	GSX-R400R	90-95	M14X10-P1.25	ZE58-1612	ZE58-1613
	RF400R/RV	93-00	M14X10-P1.25	ZE58-1612	ZE58-1613
	GSX-R600	01-16	M14X10-P1.25	ZE58-1612	ZE58-1613
	KATANA(GSF600F)	98-06	M14X10-P1.25	ZE58-1612	ZE58-1613
	GSR750	13-15	M14X10-P1.25	ZE58-1612	ZE58-1613
	GSX750S	82-86	M14X10-P1.25	ZE58-1612	ZE58-1613
	GSF750	96-00	M14X10-P1.25	ZE58-1612	ZE58-1613
	GSX-R750	00-16	M14X10-P1.25	ZE58-1612	ZE58-1613
	KATANA(GSF750F)	98-06	M14X10-P1.25	ZE58-1612	ZE58-1613
	V-Strom1000	02-15	M14X10-P1.25	ZE58-1612	ZE58-1613
SV1000S	03-07	M14X10-P1.25	ZE58-1612	ZE58-1613	
TL1000R/S	97-03	M14X10-P1.25	ZE58-1612	ZE58-1613	
GSX-R1000	01-16	M14X10-P1.25	ZE58-1612	ZE58-1613	
GSX1100S	94-00	M14X10-P1.25	ZE58-1612	ZE58-1613	
GSX-R1100	89-92	M14X10-P1.25	ZE58-1612	ZE58-1613	
GSX-S1000	16	M14X10-P1.25	ZE58-1612	ZE58-1613	
GSX-S1000F	16	M14X10-P1.25	ZE58-1612	ZE58-1613	
BANDIT1200/S	01-06	M14X10-P1.25	ZE58-1612	ZE58-1613	
GSF1200/S	95-99	M14X10-P1.25	ZE58-1612	ZE58-1613	
INAZUMA1200	98-99	M14X10-P1.25	ZE58-1612	ZE58-1613	
BANDIT1250/S ABS	07-15	M14X10-P1.25	ZE58-1612	ZE58-1613	
BANDIT1250F	15	M14X10-P1.25	ZE58-1612	ZE58-1613	
B-KING	08-09	M14X10-P1.25	ZE58-1612	ZE58-1613	
GSX1300R HAYABUSA	99-16	M14X10-P1.25	ZE58-1612	ZE58-1613	
GSX1400	05-06	M14X10-P1.25	ZE58-1612	ZE58-1613	

Swing arm spool		Gold	Ti-Color
M8	HONDA/SUZUKI	ZS93-1104	ZS93-1108
M10	KAWASAKI	ZS93-1204	ZS93-1208
M6	YAMAHA	ZS93-1404	ZS93-1408



ZETA MAGNETIC DRAIN BOLT

- Magnetic drain bolt for Sport bikes.
- Designed to pick up excess bits of metal in your engine oil.
- Made of A7009-T6 aluminum. Light weight design.
- Press fit magnet on the drain plugs.
- Includes safety wire holes to prevent misplaced part.
- Available in blue, red anodized colors.

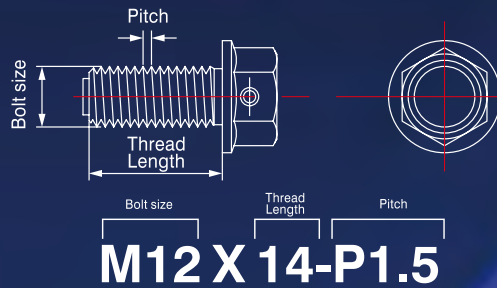

Magnetic Drain Bolt		Year	Size	Blue	Red
ADON	CBR125R	13-14	M12X15-P1.5	ZE58-1522	ZE58-1523
	GROM	13-15	M12X15-P1.5	ZE58-1522	ZE58-1523
	MSX125	13-15	M12X15-P1.5	ZE58-1522	ZE58-1523
	VTR/F	98-14	M12X15-P1.5	ZE58-1522	ZE58-1523
	CBR250R	11-16	M12X15-P1.5	ZE58-1522	ZE58-1523
	CBR250RR	90-99	M14X14-P1.5	ZE58-1622	ZE58-1623
	CB250F	14-16	M12X15-P1.5	ZE58-1522	ZE58-1523
	CB300F	15-16	M12X15-P1.5	ZE58-1522	ZE58-1523
	CBR300R	15-16	M12X15-P1.5	ZE58-1522	ZE58-1523
	400X	13-15	M12X15-P1.5	ZE58-1522	ZE58-1523
	CB400F	13-15	M12X15-P1.5	ZE58-1522	ZE58-1523
	CB400SF	92-16	M12X15-P1.5	ZE58-1522	ZE58-1523
	CBR400R	13-15	M12X15-P1.5	ZE58-1522	ZE58-1523
	CBR400RR	90-99	M12X15-P1.5	ZE58-1522	ZE58-1523
	RVF400	94-01	M12X15-P1.5	ZE58-1522	ZE58-1523
	VFR400R	89-93	M12X15-P1.5	ZE58-1522	ZE58-1523
	CB500F	13-16	M12X15-P1.5	ZE58-1522	ZE58-1523
	CB500X	13-16	M12X15-P1.5	ZE58-1522	ZE58-1523
	CBR500R	13-16	M12X15-P1.5	ZE58-1522	ZE58-1523
	CBR600F	91-06	M12X15-P1.5	ZE58-1522	ZE58-1523
	CBR600SE	98	M12X15-P1.5	ZE58-1522	ZE58-1523
	CBR600JR	96	M12X15-P1.5	ZE58-1522	ZE58-1523
	CBR600RR	03-16	M12X15-P1.5	ZE58-1522	ZE58-1523
	CB650F	14-16	M12X15-P1.5	ZE58-1522	ZE58-1523
	CBR650F	14-16	M12X15-P1.5	ZE58-1522	ZE58-1523
	NC700S/X	12-16	M12X15-P1.5	ZE58-1522	ZE58-1523
	NC750S/X	14-15	M12X15-P1.5	ZE58-1522	ZE58-1523
	RVF750/R	94-97	M12X15-P1.5	ZE58-1522	ZE58-1523
	VFR750F	90-97	M12X15-P1.5	ZE58-1522	ZE58-1523
	VFR800	98-09	M12X15-P1.5	ZE58-1522	ZE58-1523
	VFR800F/X	14	M12X15-P1.5	ZE58-1522	ZE58-1523
	CBR900RR	92-03	M12X15-P1.5	ZE58-1522	ZE58-1523
	CBR954RR	02-03	M12X15-P1.5	ZE58-1522	ZE58-1523
	CB1000	95	M14X14-P1.5	ZE58-1622	ZE58-1623
	CB1000SF	92-97	M14X14-P1.5	ZE58-1622	ZE58-1623
	CB1000R	11-16	M12X15-P1.5	ZE58-1522	ZE58-1523
	CBR1000RR	08-16	M12X15-P1.5	ZE58-1522	ZE58-1523
	RV1000R	00-06	M12X15-P1.5	ZE58-1522	ZE58-1523
	VTR1000F	97-07	M12X15-P1.5	ZE58-1522	ZE58-1523
	VTR1000SP-1/2	00-03	M12X15-P1.5	ZE58-1522	ZE58-1523
CB1100	10-15	M14X14-P1.5	ZE58-1622	ZE58-1623	
CBR1100XX	97-03	M14X14-P1.5	ZE58-1622	ZE58-1623	
ST1100	91-03	M12X15-P1.5	ZE58-1522	ZE58-1523	
X-11	99-01	M14X14-P1.5	ZE58-1622	ZE58-1623	
VFR1200F	10-14	M14X14-P1.5	ZE58-1622	ZE58-1623	
VFR1200X	14-15	M14X14-P1.5	ZE58-1622	ZE58-1623	
CB1300SF	98-16	M14X14-P1.5	ZE58-1622	ZE58-1623	
X4	97-03	M14X14-P1.5	ZE58-1622	ZE58-1623	



ZETA SWING ARM SPOOL

- CNC machined aluminum swing arm spool.
- Can be used with most street racing stands available on the market.
- Available in M6, M8 and M10 bolt sizes to fit most Japanese street bikes.
- Available in titanium and gold colors.
- Comes in pairs.



ZS93-3404



ZS93-3108

ZETA

CHAIN ADJUSTER CAP

- ZETA Chain adjuster for sport bikes.
- Made of CNC machined aluminum with titanium and gold anodized finish.
- ZETA laser printed logo.
- Comes in pairs.

Chain Adjuster Caps			
Bike	Year	Gold	Ti-color
HONDA			
CB250F	14-16		
CBR250R	11-16	ZS93-3104	ZS93-3108
CB300F	14-16		
CBR300R	14-16		
YAMAHA			
YZF-R25	15-16		
YZF-R3	15-16	ZS93-3404	ZS93-3408
MT-25	16		
MT-03	16		
KAWASAKI			
NINJA250/R	08-17		
NINJA250SL	15-16		
Z250	13-16	ZS93-3104	ZS93-3108
Z250SL	15-16		
NINJA300	13-16		

ZS93-3404 YZF-R25



ZS93-2408

ZS93-2304

ZS93-2404 YZF-R1 (L)

ZETA

REAR AXLE BLOCK

- ZETA Axle block for sport bikes.
- Made of CNC machined aluminum with titanium and gold anodized finish.
- Scales on both sides of axle block for easy chain adjustment.
- ZETA laser printed logo.
- Comes in pairs.

Rear Axle Block			
Bike	Year	Gold	Ti-color
HONDA			
CBR600RR	09-16	ZS93-2104	ZS93-2108
CBR1000RR	08-16		
YAMAHA			
FZ8	11-13		
FZ1	06-15	ZS93-2404	ZS93-2408
YZF-R1/M	04-16		
KAWASAKI			
ZX-6R	09-16	ZS93-2204	ZS93-2208
ZX-10R	11-16		
SUZUKI			
GSX-R600	00-09		
	11-16		
GSX-R750	00-09	ZS93-2314	ZS93-2318
	11-16		
GSX-R1000	01-16		
HAYABUSA	08-16		

ZS93-2404 YZF-R1 (R)





DRC RADIATOR HOSE

- Durable silicone radiator hose for street bikes.
- Smooth inner surface allows for increased coolant flow.
- Printed white DRC logo.
- Available in red, blue and orange colors.

Bike	Year	Red	Hose qty
HONDA			
CB250F	14-16	D47-05-113	2
CBR250R	11-16	D47-05-113	2
VTR	09-15	D47-05-143	4
400X	13-16	D47-05-253	4
CB400F	13-16	D47-05-253	4
CB400SF	08-15	D47-05-223	4
CBR400R	13-16	D47-05-253	4
CB500X	13-16	D47-05-253	4
CB500F	13-16	D47-05-253	4
CBR500R	13-16	D47-05-253	4
CTX700/N	13-16	D47-05-323	3
NC700X/S	12-16	D47-05-323	3
NC750X/S	14-15	D47-05-323	3
CBR1000RR	12-15	D47-05-423	10
YAMAHA			
FZ07	15-16	D47-08-473	5
MT07	14-16	D47-08-473	5
FZ09	14-16	D47-08-493	5
MT09/TRACER	14-16	D47-08-493	5

Bike	Year	Blue	Hose qty
YAMAHA			
FZ-1/FAZER	11-15	D47-08-462	6
YZF-R1	10-14	D47-08-422	7

Bike	Year	Red	Hose qty
KAWASAKI			
Z250	13-16	D47-06-143	5
Ninja 250	13-16	D47-06-143	5
Ninja 300	13-15	D47-06-143	5
ER-4n	11-13	D47-06-223	2
Ninja 400R	11-13	D47-06-223	2
ER-6f	09-11	D47-06-223	2
ER-6n	09-11	D47-06-223	2
Ninja 1000	11-16	D47-06-323	6
ZRX1200DAEG	09-16	D47-06-423	4
ZX-14R	12-16	D47-06-453	5
SUZUKI			
GSR250	12-15	D47-07-123	6
GW250	12-15	D47-07-123	6
Inazuma250	12-15	D47-07-123	6
GLADIUS400	09-15	D47-07-223	4
GSX-R1000	12-16	D47-07-413	3
GSX1300R			
Hayabusa	08-15	D47-07-553	3

Bike	Year	Orange	Hose qty
KTM			
125DUKE	11-16	D47-09-129	4
200DUKE	11-16	D47-09-129	4

High heat resistance and durable silicon rubber

Durable mesh fiber



DRC MIRROR HOLE PLUG

- Aluminum screw cap to seal your mirror hole.
- Protect your mirror hole thread from water, dust and mud.
- Made of 7009 aluminum, bolt size = M10 - 1.25
- Available in 4 different anodized colors.

Part number	Color
D41-06-502	Blue
D41-06-503	Red

Part number	Color
D41-06-508	Titanium
D41-06-509	Gold



DRC RADIATOR CAP

- High pressure radiator cap for racing use.
- High pressure of 1.6 kgf / cm² increases coolant's boiling point.
- Prevents the boiling and vaporization of the coolant during hard riding.
- Protects your engine from overheating.

Part number
D47-31-016



D45-10-110



D45-10-310



D45-10-350



NINJA 250



YZF-R25



MT-09

DRC
FENDER ELIMINATOR KIT

- Fender eliminator kit makes rear fender compact and cool looking.
- Designed to mount OE flasher and license plate light.
- Made of durable steel with black paint finish.
- Comes with license plate holding bolts, washers and nuts.

	Bike	Year	Part #
YAMAHA	YZF-R25/R3	15-16	D45-10-310
	MT-09/FZ-09	14-16	D45-10-350
Kawasaki	Ninja 250/300/Z250	13-16	D45-10-110



Flex-1

Flex-3

DRC
MOTO LED FLEX TAIL LIGHT

Flex-1 [D45-29-310](#)

- Flex fit shell and body with 16 high quality chip LEDs.
- Even fits curved surfaces.
- Tail light and stop light in this compact-sized product.
- High impact, water and shock resistant.
- Includes aluminum bolts and nuts.
- Plug type terminals are included for installation.
- Works on 12 V AC / DC.
- Dimensions : L 109 mm x W 19 mm x H 9 mm.

Flex-3 [D45-29-316](#)

- Universal LED tail light.
- 12 pcs oval LEDs.
- Tail light and stop light in this compact-sized product.
- Reduced electric power consumption
- Works on 12 V AC / DC.
- Dimensions : L 109 mm x W 19 mm x H 19 mm

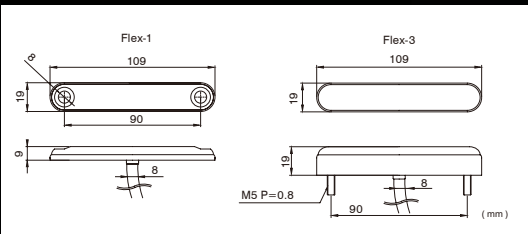

DRC
MOTO LED PHANTOM TAIL LIGHT

- High intensity LED light for the rear fender.
- Tail light base is made of flex rubber. Enables a great fit on all shapes of rear fenders with M 5 bolts.
- 8 high-intensity LEDs are used.
- Tail light and stop light in this compact-sized product.
- Plug type terminals are included for installation.
- Works on 12 V AC / DC.

Part number [D45-29-307](#) **Color** Red

Replacement lens	
Part number	Color
D45-29-387	Red

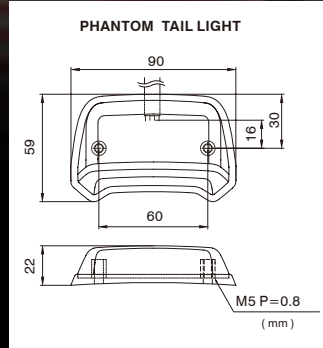

Orange

Smoke

Clear

DRC
MOTO LED 602 LED FLASHER

- Flexible flasher stays to prevent breakage upon impact.
- Lens colors available: orange, smoke and clear.
- Terminals and nuts are included for installation.
- Comes in pairs. Works on 12 V AC / DC.

Part number	Color	Replacement lens	
		Part number	Color
D45-60-207	Orange	D45-60-287	Orange
D45-60-208	Smoke	D45-60-288	Smoke
D45-60-209	Clear	D45-60-289	Clear

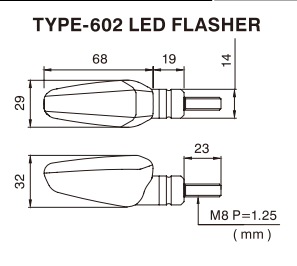

Orange

Smoke

DRC
MOTO LED 586 LED FLASHER

- Installs on the fender with screws for secure installation.
- Rubber mount base fits even curved surfaces.
- Terminals and bolts are included for installation.
- Comes in pairs. Works on 12 V AC / DC.

Part number	Color	Replacement lens	
		Part number	Color
D45-58-617	Orange	D45-58-687	Orange
D45-58-618	Smoke	D45-58-688	Smoke

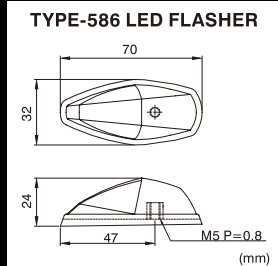

Orange

Smoke

DRC
MOTO LED 601 LED FLASHER

- Triangular style flasher.
- Terminals and nuts are included for installation.
- Comes in pairs. Works on 12 V AC / DC.

Part number	Color	Replacement lens	
		Part number	Color
D45-60-107	Orange	D45-60-187	Orange
D45-60-108	Smoke	D45-60-188	Smoke

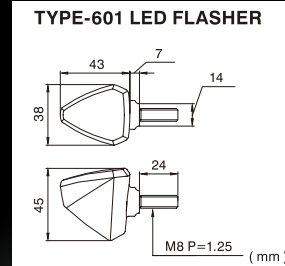

DRC
MOTO LED FLASHER HOLDER PLATE

- Flasher mount adapter for Yamaha and Kawasaki OEM flasher mounting bracket.
- Use OE brackets with the plates to mount DRC LED flashers.
- Flasher attachment hole diameter : 8 mm
- Available in titanium, blue and black anodized colors.
- 2 set.

Part number [D45-59-950](#) **Color** Titanium
[D45-59-952](#) **Color** Blue
[D45-59-953](#) **Color** Black

Bike	Year
WR250R/X	07-
FZ1-N/S	08-
YZF-R6	06-
YZF-R1	07-
MT-01	05-
KLX125/D-Tracker125	10-
KLX150	09-
KLX250/D-Tracker	08-
Ninja 250R	08-

MOTO LED flashers may not work properly without optional parts. P129

HC2

Height Control System

LIFT STAND



BLACK

RED

DRC
HC2 LIFT STAND

- Height adjustable lift stand for dirt bikes.
- Top plate is height-adjustable to fit under most dirt bikes.
- Easily operated durable double long-levered jack-pedal.
- Available red and black colors.
- Maximum lifting weight is 150 kgs. (330 lbs)

Part number	Color	PAT. 200520100979.6
D36-38-311	Black	
D36-38-312	Red	



Fits under most dirt bikes.
Adjustable range : 250 mm - 350 mm
(10 to 14 inches)



Damper shock eliminates the sudden drop, and provides a smooth, safe landing.



Designed for small to full size dirt bikes.



Easily operated durable double long-levered jack-pedal.



Height-adjustable top plate can be secured with the lock nut.



The Top Plate has a thick, non slip rubber surface.



" Safety Hold Hook " system prevents any accidents after lifting the bike.

STAND



TRANSPORT



TOOL



CONTROL



EXHAUST



ELECTRICAL



DRIVE



BODY



ACCESSORIES





Used by
JMX TEAM SUZUKI

DRC RACER STAND

- Light weight aluminum box style racer stand.
- Weighs less than 3 kgs (105 oz) and is very stable.
- Stand available with or without panel.
- Made of aluminum. Stand height : 420 mm

.With panel
Part number
D36-31-011

.Without panel
Part number
D36-31-021



D36-31-011



D36-31-021

DRC GARAGE STAND

- Box garage stand made of durable steel.
- High type available for full size dirt bikes and medium type for Super Moto and street bikes.

.High
Part number
D36-31-101

.Medium
Part number
D36-31-102

Height : 420 mm

Height : 375 mm



D36-31-101



D36-31-102



REPLACEMENT TOP PLATE
Part number
D36-31-910



OPTION TRAY
Part number
D36-31-900



DRC TRIANGLE STAND

- Quick and easy side stand, hooks into rear axle.
- For use on bikes with rear axles of inner diameters 18 mm, 14.5 mm, and 11 mm.
- When you need to move your bike, just hang it on the foot peg.

.MX type A 365 mm B 335 mm

Part number Color
D36-39-011 Gunmetal

.Super Motard type A 325 mm B 295 mm

- For SuperMoto bikes with 17 " wheels.

Part number Color
D36-39-021 Gunmetal

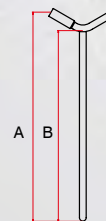

18mm	Year	11mm	Year	14.5mm	Year
CRF450R	02-17	KX125/250	90-02	RM125/250	02-08
CRF450RX	17	KLX250R/300R	ALL	YZ125/250	99-17
CRF250R	04-17	KDX200-250	ALL	YZ400F-450F	99-08
CR125R/250R	00-07	DR250R	ALL	YZ250F	01-08
RMZ450	05-17	DT200WR	ALL	YZ250FX	15-17
RMZ250	04-17	RM85L	ALL	YZ450FX	16-17
KX450F	06-17	DRZ400S/SM	00-16	YZ125X	17
KX250F	04-17	125-530SX/SX-F	-12	YZ250X	16-17
KX125/250	03-08	125-530EXC/EXC-F	ALL	WR250R/X	ALL
YZ450F	09-17	TC125	14-15		
YZ250F	09-17	TC250	14-16		
125-530SX/SX-F	13-17	FC250/350/450	14-15		
TC125	16-17	TE/FE125-501	14-17		
TC250	17	TX125	17		
FC250/350/450	16-17				
FC250/450(US)	15-17				
TX300	17				
FX350/450	17				



STAND



TRANSPORT



TOOL



CONTROL



EXHAUST



ELECTRICAL



DRIVE



BODY



ACCESSORIES



DRC
HYBRID RAMP

- Light weight construction**
- Aluminum alloy, and nylon tube / plate construction.
 - Tongue for attaching to truck bed.
 - Nylon supports, lightweight, yet strong.
 - Very compact when folded. (Folding type)
 - 4 different sizes to suit any need.
 - 20 cm width (8")
- PAT. 200520100997.4**



Non-slip rubber under the tongue to prevent slippage and protect your truck bed.



ABS constructed foot caps for stability.



4 different style ramps to fit your needs.



Folding type takes less space in your van or truck.

Straight type



D36-41-115

Folding type



D36-41-618

D36-41-621

D36-41-624

Straight type

Part number	Width × Length	Weight Capacity
D36-41-115	20 cm × 150 cm (8" × 5')	up to 210 kgs (463 lbs)

Folding type

Part number	Width × Length	Weight Capacity
D36-41-618	20 cm × 180 cm (8" × 6')	up to 190 kgs (419 lbs)
D36-41-621	20 cm × 210 cm (8" × 7')	up to 175 kgs (386 lbs)
D36-41-624	20 cm × 240 cm (8" × 8')	up to 165 kgs (364 lbs)



DRC
MOTO BINDING

- 2 way innovative style tire chock can be used for pit bikes to full size dirt bikes. (Accepts 8 to 21 inch wheels.)
- Maximum tire width : 130 mm / 5.2 inch
- Folding design saves space. Height is 135 mm / 5.4 inch when folded.
- Accepts mini wheels (Up to 12 inch) even while it is folded.
- Self lock function prevents arm from opening up unexpectedly from folded position.
- Using the wheel chock fitting kit ([D36-51-391](#)) makes it easy to attach and remove.

Part number
[D36-51-101](#)

STAND



TRANSPORT



TOOL



CONTROL



EXHAUST



ELECTRICAL



DRIVE



BODY



ACCESSORIES



DRC
WHEEL CHOCK

- Standard tire chock for your van or truck.
- Made of 22 mm diameter pipe.
- Maximum tire width : 130 mm (5.2 inch)
- Using the wheel chock fitting kit ([D36-51-391](#)) makes it easy to attach and remove.

Part number
[D36-51-014](#)



DRC
TIE-DOWN HOOK STD

- Tie-down hook for your van or truck.
- Provides an additional hook point for tie downs.
- Clamp bolt : M8. 2 pcs.

Part number
[D36-11-110](#)

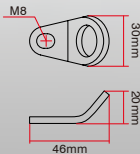

DRC
TIE-DOWN HOOK SWIVEL

- Swivel-style tie-down hook for your van or truck.
- Provides an additional hook point for tie downs.
- Clamp bolt : M8. 2 pcs.

Part number
[D36-11-120](#)

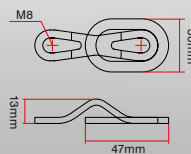

DRC
TRANSPORTER CLAMP HOOK

- Clamp hook for your van or truck.
- Provides an additional hook point for tie downs.
- Clamp diameter : 22 - 26 mm

Part number
[D36-11-221](#)

DRC
WHEEL CHOCK FITTING KIT

- Wheel Chock Fitting Kit makes it easy to attach and remove the DRC Moto Binding or Wheel Chock.
- 6.2 mm diameter x 10 mm. 2 pcs.

Part number
[D36-51-391](#)



**T2 RATCHET TIE-DOWN
T2 CAM BUCKLE TIE DOWN
SOFT HOOK**



→ **P105**



**Best for use with
pick up truck**

RACER COVER

DRC
RACER COVER



- Specially designed for MX and ED race bikes. (Over 125 cc)
- The bike can be moved with the cover on by opening the front and rear zippers.
- Secure adjustment of tie down belts by opening upper zipper.
- Protect your bike during transportation.
- Bike cover can be used in your pits to keep your bike clean and protect the bike from night dew.

Part number
D57-02-101

Size
223 cm (87.8 inch) Height : 140 cm (55 inch)



Belt loops on front and center of bike cover to prevent wind flap during transport.



Loading your bike with bike cover on and protect your bike during transportation.



Upper zipper for tie down access, easy to operate by double zipper.



Step 1

Remove velcro strap and open the zipper on front wheel.



Step 2

Lace the velcro flap on to loop on front fender and secure.



Step 3

Loosen hem adjusting cord at bottom center on bike cover.



Step 4

Now the front tire is free to move.



Step 5

Do the same routine for the rear wheel.



Step 6

Open the zipper around handlebar and attach soft tie.



Step 7

Can be loaded with bike cover on.



Step 8

Tie down the bike and closed upper zippers.



Step 9

Close zippers and fasten velcro straps.



Step 10

Used belt loops to prevent wind flap during transport.

DRC OFF ROAD MOTORCYCLE COVER



- Specially designed for off road bikes.
- Made of 300 denier durable material with water proof, water repellent and UV protection finish.
- Front and lower side colored in blue to easily find bike cover direction.
- Hem adjusting cords and belts prevent wind flapping of bike cover.
- Slit openings on front and back for security locks.
- Available 2 sizes, comes with storage bag.

Part number	Size	
D57-01-101	M	Lengh 225 cm (88.58 inch)
		Height 160 cm (62.99 inch)
D57-01-102	L	Lengh 250 cm (98.43 inch)
		Height 175 cm (68.9 inch)

FUNCTION



Hem adjusting cord provides tight cover fit on your bike to prevent flapping of the cover.

Slit openings on front and back for security lock. Lock diameter : 6 cm / 2.4 inch

2 adjustable belts prevent bike cover wind flap. Easy to use with buckles on the belts.

Storage bag has a mesh panel to drain water from wet bike cover. Loop for easy storage and drying.

Size	HONDA	YAMAHA	SUZUKI	KAWASAKI	KTM	HUSQVARNA	GASGAS	etc.
M	CRM50/80 XR50/100 Motard XR230/Motard FTR223.TLM220R SL230 XL230 Degree AX-1	DT50 XTZ125E TT-R125LW/LEW TW200/E TW25/E Serow225/W/WE XT250X Tricker,Bronco	TS50R GrassTracker GrassTracker BigBoy	D-Tracker125 Super Sherpa KLX125/150S			Pampera125	
L	CRM250/R/AR XR250/400Motard XR250/R/Baja XR400R/600R/650R XLR125R/200R XLR250/R/Baja CRF250L/M	DT125R/200R DT200WR DT230 Lanza TTR250R/Raid WR250R/X Serow250 XT400E Artesia	Djebel125/200/250 Djebel250XC DR250/S/R DR350 DRZ400/S/SM/R RMX250S/R DF125E/200E TS125R/200R SX125R/200R Van Van200 250SB	KDX125SR/200SR KDX220SR KDX250SR KLX250S/R/SR/ES/SF KLX300R/450R D-Tracker/X KLE250/400 250TR	125EXC/ 200EXC 250EXC/-R/-F 300EXC 400LC-4 400EXC/-R 450EXC/-R 525EXC/-R 530EXC/-R 690 Enduro/ SMC	TE250/310 TE450/630 WR125/250/360 SM125/250R SM400R/450R SM450RR/510R SM570/610 SMS630	Halley125R EC125/250 EC450	Husaberg TE250 Husaberg FE390/450 Husaberg FE570 Husaberg FS570 tm EN250



DRC TIE-DOWN SOFT HOOK

- Designed to compensate for attachment points not accessible with hooks.
- Wrap around handle bars, sub frame etc and insert flat loop through twisted loop and attach tie-down hook.
- Comes in pairs.

Part number	Color
D36-05-010	Blue
D36-05-020	Black
D36-05-030	Red



DRC T2 RATCHET TIE-DOWNS

- Ratchet buckle tie-down for greater tensioning power.
- Vinyl coated hooks with 25 mm wide, thick and durable strap.
- Rubber covers on ratchet handle and release levers.
- Easy to operate even in narrow and small spaces.
- Comes in pairs.
- Comes with loop strap to prevent damaging your bike.
- Safety hook included to prevent the tie-down from easily coming off.

Part number	Color
D36-05-510	Blue
D36-05-520	Black
D36-05-530	Red



DRC T2 CAM BUCKLE TIE-DOWNS

- Standard cam buckle tie-down.
- Vinyl coated hooks with 25 mm wide, thick and durable strap.
- Comes in pairs.
- Comes with loop strap to prevent damaging your bike.
- Safety hook included to prevent from the tie-down from easily coming off.

Part number	Color
D36-05-410	Blue
D36-05-420	Black
D36-05-430	Red



Comes with karabiner secure hook.



Comes with loop strap to prevent damaging your bike.

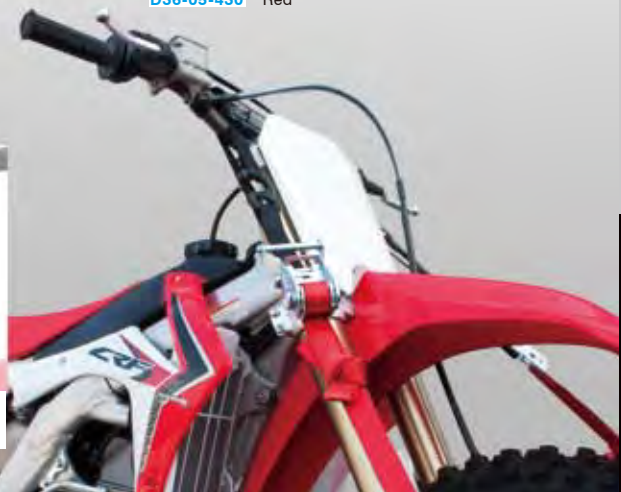

DRC HARDWARE

STAND



TRANSPORT



TOOL



CONTROL



EXHAUST



ELECTRICAL



DRIVE



BODY



ACCESSORIES



DRC

PRO SPOON TIRE IRON WITH WRENCH

- One end fits the axle nut, the other end is a tire tool.
- Made of heat treated steel.
- 25 cm (10") to 26.5 cm (10.6") wrench length.
- Wrench available in 6 sizes.

Part number	Wrench Size	Part number	Wrench Size
D59-10-917	17 mm	D59-10-924	24 mm
D59-10-919	19 mm	D59-10-927	27 mm
D59-10-922	22 mm	D59-10-932	32 mm



AXLE SHAFT NUT CHART

Bike	Year	Front	Rear
HONDA			
CR80R/85R		19mm	22mm
CRF150R	07-17	22mm	24mm
CR125R/250R		22mm	32mm
CRF250R/450R	02-17	22mm	32mm
CRF450R X	17	22mm	32mm
CRF250X/450X	04-17	22mm	32mm
CRM50/80		19mm	22mm
XR230		17mm	24mm
SUPER XR250/BAJA		17mm	24mm
CRM250/R/AR		19mm	24mm
CRF250L/M	12-16	17mm	24mm
YAMAHA			
YZ125/250	-17	22mm	27mm
	-08	22mm	27mm
	09	22mm	32mm
YZ250F	10-17	22mm	30mm
	-08	22mm	27mm
	09	22mm	32mm
YZ450F	10-17	22mm	30mm
	17	22mm	27mm
YZ250X	16-17	22mm	27mm
YZ250FX/450FX	15-17	22mm	27mm
WR250F/450F	-17	22mm	27mm
WR250R/X	07-17	22mm	27mm
XT250/SEROW250	-16	19mm	19mm
SEROW225		22mm	22mm
SEROW225WE		22mm	19mm
DT230LANZA		17mm	27mm
TT250R/RAID		17mm	24mm
KAWASAKI			
KX65		17mm	17mm
KX85/100	-17	17mm	18mm
KX125/250	-08	22mm	32mm
KX250F/450F	04-	22mm	32mm
KLX450R	08-	22mm	32mm
KLX125	10-16	17mm	22mm
D-TRACKER125	10-16	17mm	22mm
SUPER SHERPA		17mm	22mm
KLX250	98-07	17mm	27mm
D-TRACKER	98-07	17mm	27mm
KLX250	08-16	19mm	27mm
D-TRACEKR X	08-16	19mm	27mm

Bike	Year	Front	Rear
SUZUKI			
RM125/250	-08	21mm	32mm
RMZ250	04-06	22mm	32mm
	07-17	21mm	32mm
RMZ450	05-17	21mm	32mm
DJEBEL125/200		17mm	19mm
DJEBEL250		19mm	19mm
DR250S		17mm	24mm
DR250R		19mm	24mm
RMX250S/R		19mm	24mm
250SB		17mm	27mm
DRZ400S/SM	00-16	24mm	24mm
KTM			
85SX		14mm	27mm
125-450SX/SX-F/XC-F	-12	27mm	27mm
	13-	27mm	32mm
125-450EXC/EXC-F/XC-W		27mm	27mm
FREERIDE250R/350		14mm	27mm
HUSQVARNA			
TC85	14-17	14mm	27mm
	14-15	27mm	27mm
TC125	16-17	27mm	32mm
	14-16	27mm	27mm
TC250	17	27mm	32mm
	14-15	27mm	27mm
FC250/350/450	16-17	27mm	32mm
FC250/450(US)	15-17	27mm	32mm
TE/FE125-501	14-17	27mm	27mm
TX125	17	27mm	27mm
TX300	17	27mm	32mm
FX350/450	17	27mm	32mm

DRC

BEAD HOLDER

- Keeps the tire bead down during the tire change.
- Hooks over the spoke and pushes down on the bead for easy tire installation.
- Durable rubber grip for easy operation.

Part number
D59-11-071



1. Insert the tire bead into the wheel rim after installing the tube.
2. Insert lever part of the bead holder into the wheel rim and hook over spoke as shown above picture.
3. Keep the tool inserted and insert the tire bead into the wheel rim.
4. Tire bead won't come off with bead keeper. Smooth and easy operation.



DRC
AIR VALVE CORE DRIVER

- Valve core remover designed for quick operation.
- Remover tip is made of chrome molybdenum steel for durability.
- Aluminum knurled grip.
- Length : 45 mm

Part number
D59-04-100 Titanium
D59-04-103 Red



DRC
PRO SPOON TIRE IRON

- Designed for all types of tire changing needs.
- The bend of the lever and wide spoon area is designed for quick and easy tire removal.
- The durable rubber grip provides better grip.
- Available in 2 different lengths.

Part number
D59-10-113 230 mm (9.2")
D59-10-012 260 mm (10.4")



DRC
TIRE IRON 400 mm

- Standard tire lever.
- Long length for easy operation for hard tire removal.
- Made of durable heat treated steel.

Part number
D59-10-005



DRC
BEAD CREAM

- Compact bead cream fits any tool box.
- Comes in a compact plastic case. (Net : 40 g)
- Includes application sponge.

Part number
D51-50-120

STAND



TRANSPORT



TOOL



CONTROL



EXHAUST



ELECTRICAL



DRIVE



BODY



ACCESSORIES





STEP 1: Pass air valve puller head through the valve hole.



STEP 2: Install valve puller head on air valve on the tube.



STEP 3: Replace air valve in the tire.



STEP 4: Pull on the air valve wire. The air valve will appear.



MXA RATING

★★★★★

This simple little tool is worth its weight in gold when it comes time to go valve stem fishing.

DRC
AIR VALVE PULLER

- Easy to pull the air valve stem through the hole on the rim.
- Useful during tire changes and flat repairs.
- Air valve puller head may also be used for air valve core removal.

Part number	Color
D59-38-201	Black
D59-38-202	Red
D59-38-203	Blue



ENDURO

Yutaro Uchiyama

STAND



TRANSPORT



TOOL



CONTROL



EXHAUST



ELECTRICAL



DRIVE



BODY



ACCESSORIES





Presta / Schrader
Motorcycle / MTB
Dual stroke

DRC C301 MINI PUMP

- Dual stroke internal parts, pump on both pushing and pulling motion.
- Light weight and compact 6063 aluminum barrel.
- T-handle for better inflation.
- Reversible adapter fits Presta and Schrader valves.

Part number : D59-35-301
Maximum Pressur : 820 kPa / 120 psi
Body size : L 270 x W 40 x H 25 mm
Weight : 110 g

Folding position



Presta / Schrader
Motorcycle / MTB
Anti-Air Loss valve

DRC C303 MINI PUMP

- Portable mini pump made of CNC machined aluminum.
- Integrated extendable hose for portability.
- One touch switchover valve system fits Presta and Schrader valves.
- Anti air loss valve attachment prevents air from leaking during pumping.

Part number : D59-35-303
Maximum Pressur : 550 kPa / 80 psi
Body size : L 240 x W 25 x H 25 mm
Weight : 135 g

Folding position

One touch switchover valve system



Presta / Schrader
Motorcycle / MTB
Floor type

DRC C302 MINI FLOOR PUMP

- Floor pump style for stable air pumping.
- Compact design for portability.
- T-handle for easier inflation.
- Rotating and extendable hose for easy operation.

Part number : D59-35-302
Maximum pressur : 960 kPa / 140 psi
Body size : L 275 x W 50 x H 30 mm (Folded position)
Hose length : 300 mm
Weight : 153 g

Folding position

360 degree rotating hose



Presta / Schrader
Motorcycle / MTB

DRC G101 AIR GAUGE

- Air gauge specially designed for motorcycle and mountain bike.
- Micro adjust button for sensitive air reduction adjustment.

Part number : D59-36-101
Pressur range : 0 - 400 kPa (58 psi)
Body size : L 105 x W 50 x H 30 mm
Weight : 95 g

Micro adjust button

Schrader

Presta



Presta / Schrader
Motorcycle / MTB

DRC F501 FLOOR PUMP

- Pump body is made of durable aluminum tube for lighter weight and durability.
- High pressure with minimum pumping power.
- Smart head air valve head automatically adjusts to fit Presta and Schrader valves.

Part number : D59-35-501
Maximum pressur : 1079 kPa (11 kgf / cm²)
Body size : H 610 mm x W 240 mm
Weight : 1.0 kg

Smart head



Presta / Schrader
Motorcycle / MTB

DRC F503 FLOOR PUMP

- Pump body is made of durable aluminum tube for lighter weight and durability.
- High pressure with minimum pumping power.
- Smart head air valve head automatically adjusts to fit Presta and Schrader valves.
- Micro adjust button on Smart head for precise air adjustment.

Part number : D59-35-503
Maximum pressur : 1079 kPa (11 kgf / cm²)
Body size : H 650 mm x W 260 mm
Weight : 1.1 kg



Gauge



Micro adjust button

Smart head

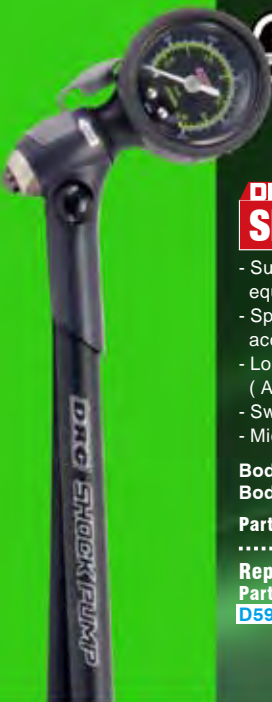

SHOCK PUMP

350kPa
50psi

DRC
SHOCK PUMP 350 kpa (50 psi)

- Suspension air pump developed for front air suspension equipped models.
- Specially designed gauge for the new air suspension shows accurate air pressure. Max 3.5 bar (50 psi)
- Long stroke pump body designed for fewer pumps. (Approximately 60 pumps per fork leg.)
- Swivel valve is easy to connect even in limited spaces.
- Micro adjust button for precise air pressure adjustment.

Body Size L 365 mm x W 82 mm x H 37 mm
Body Weight 240 g

Part number [D59-35-101](#)

Replace swivel hose
Part number [D59-35-189](#)

Replace gauge
Part number [D59-35-181](#)



Big panel display



Swivel Head

- STAND
- TRANSPORT

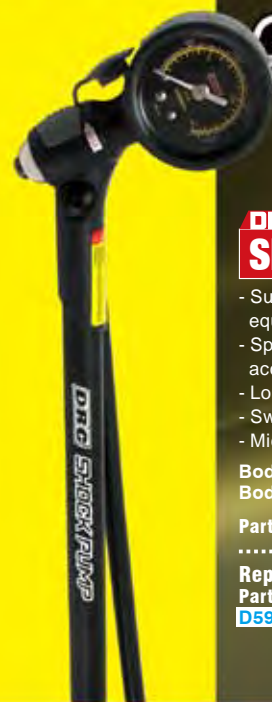

SHOCK PUMP

1500kPa
220psi

DRC
SHOCK PUMP 1500 kpa (220 psi)

- Suspension air pump developed for front air suspension equipped models.
- Specially designed gauge for the new air suspension shows accurate air pressure. Max 15 bar (220 psi)
- Long stroke pump body designed for fewer pumps.
- Swivel valve is easy to connect even in limited spaces.
- Micro adjust button for precise air pressure adjustment.

Body Size L 365 mm x W 82 mm x H 37 mm
Body Weight 240 g

Part number [D59-35-102](#)

Replace swivel hose
Part number [D59-35-189](#)

Replace gauge
Part number [D59-35-182](#)



Big panel display



Swivel Head

- TOOL
- CONTROL
- EXHAUST
- ELECTRICAL



Digital SHOCK PUMP

MAX 300psi
21 kg/cm² 20 bar

DRC
DIGITAL SHOCK PUMP

- Comes with maximum 300 psi high accuracy digital gauge for sensitive air adjustment.
- Pressure unit is switchable to psi, bar, Kg and cm².
- Swivel valve is easy to connect even in limited spaces.
- Micro adjust button for sensitive air pressure adjustment.
- Pump cylinder is made of A6063 aluminum alloy. 207 g light weight body.
- Long stroke air pump design for more air pumping and less pumping time for big bore front fork on MX bikes.
- 290 mm rotating long air hose.
- LCD display is clear and easy to see.

Body Size L 365 mm x W 30 mm x H 35 mm
Body Weight 233 g

Part number [D59-35-105](#)



360°rotating long air hose



Swivel Head

- DRIVE
- BODY
- ACCESSORIES



KYB 49 mm

KYB 50 mm

WP 50 mm

DRC FORK CAP WRENCH

- Wrench for removing front fork cap.
- 2 wrench sizes available, 49 mm for KYB and 50 mm for SHOWA and 50 mm KTM WP front fork.
- Open wrench design for easy operation in small spaces.
- Opposite end of the wrench is a rod stopper to hold piston rod when removing piston inner cartridge.
- Socket hole available for torque wrench. (Socket size is 9.5 sq = 3 / 8 inch)
- Made of durable steel, electro coating finish with DRC sticker.



Bike	Year	F-Fork	Part #
CRF450R	09-14	KYB(49 mm)	D59-24-001
YZ125/250	06-17		
YZ250F/450F	06-17		
YZ125X	17		
YZ250X	16-17		
YZ250FX	15-17		
YZ125X	17		
YZ450FX	16-17		
WR250F	15-17		
WR450F	13-17		
KX450F	06-14	SHOWA(50 mm)	D59-24-002
RMZ250	16-17		
CRF250R	04-17		
CRF450R	04-08		
CRF250X	06-17		
CRF450X	05-17		
KX250F	06-16		
KX450F	15-17		
RM125	06-08		
RM250	07-08		
RMZ250	07-15		
RMZ450	05-17		

Bike	Year	F-Fork	Part #
125-150SX	07-15	WP(50 mm)	D59-24-003
125-150SX(AIR)	16-17		
250SX/SX-F	07-15		
250SX/SX-F(AIR)	16-17		
350SX-F	11-15		
350SX-F(AIR)	16-17		
450SX-F	07-15		
450SX-F(AIR)	16-17		
150XC	10-13		
250/300XC	08-13		
250-450XC-F	08-13		



KYB

WP

4CS

DRC FORK COMPRESSION VALVE REMOVAL TOOL

- Fork compression valve removal tool for KYB, SHOWA, and KTM WP front forks.
- Use this tool with DRC fork cap wrench for removing compression valve from the inner cartridge.
- Made of aluminum, anodized finish with DRC laser printed logo and wrench size.



Bike	Year	F-Fork	Part #
YZ125/250	05-17	KYB	D59-24-016
YZ250F/450F	05-17		
YZ125X	17		
YZ250X	16-17		
YZ250FX	15-17		
YZ450FX	16-17		
WR450F	12-17		

Bike	Year	F-Fork	Part #
KX250	05-08	KYB	D59-24-016
KX450F	06-12		
KLX450R	07-15		
CRF450R	09-12		

Bike	Year	F-Fork	Part #
KX250F	13-17	SHOWA	D59-24-020
KX450F	15-17		
RM-Z450	15-17		
KTM	-	WP	D59-24-026
		WP(4CS)	D59-24-027



DRC SEALING BOLT ATTACHMENT

- Removable tool for SHOWA SFF air fork bottom sealing bolt.
- Specially designed for SHOWA SFF Air fork.
- Sealing bolt size = Allen key 22 mm
- Can be used front suspension equipped on CRF250R, KXF450, RMZ450'15-

Part number
D59-37-120 SHOWA SFF-AIR



FORK SEAL DRIVER

FORK DIAMETER
Φ40 - Φ50



CAN BE USED FOR FULL SIZE MX, ED AND DUAL SPORTS BIKES



DRC FORK SEAL DRIVER 40-50

- Specially designed fork seal driving tools for front forks.
- Comes with 5 different size plastic adapters. Can be used for almost all of conventional and up side down front forks.
- Flange shape design of steel body for accurate operation with less power.

Body: Steel Body
 adapter size (mm): 40/41, 42/43, 45/46, 47/48, 49/50
 Part number **D59-26-005**
 Replacement adapter set **D59-26-909**



■ Fork diameter 40 mm-50 mm

Use the best size from 5 adapters.
 Won't damage seals.
 Fitting angle of the seals will always be correct.

■ Ergonomic flange body shape

Flange body shape for accurate operation.
 Best body weight to drive seals.



■ Plastic adapters to prevent damage to inner tube

Plastic adapters won't damage inner tube during seal driving.



DRC FRONT FORK SEAL INSERT GUIDE

- Front fork dust and oil seal insert guide.
- Prevents damaged seals during installation.
- Made of smooth surface stainless steel for easy installation of your dust and oil seals.
- Available many sizes to fit most motorcycle front forks.

Part number	Size	Part number	Size
D59-37-141	41 mm	D59-37-147	47 mm
D59-37-143	43 mm	D59-37-148	48 mm
D59-37-145	45 mm	D59-37-149	49 mm
D59-37-146	46 mm		

STAND



TRANSPORT



TOOL



CONTROL



EXHAUST



ELECTRICAL



DRIVE



BODY



ACCESSORIES





DRC RCU BLEED CUP

- Air bleeding tool for rear suspension use.
- It also can be used with suspension comes with bleeding bolt.
- For KYB rear shock use.

Part number **D59-37-160**

	Bike	Year		Bike	Year
H	CRF450R	09-16	S	KX80/85	89-13
	YZ125/250	00-17		KX125/250	00-08
	YZ250F	01-17		KX250F	04-05
	YZ426F/450F	00-17		KX450F	06-14
Y	YZ125X	17		KLX450R	07-16
	YZ250X/450FX	16-17	K	RM250	01-02
	YZ250FX	15-17		RM-Z250	04-06
	WR250F/450F	03-17			16-17
			TC	TC250	12-13
				TC449	11-13
				TXC449/511	11-13
				TE250/310	12-13
				TE449/511	11-13

BLEEDING BOLT TYPE

Use only cup for the suspension equipped air bleeding bolt.



Rotating bleed cup to change its angle for better air bleeding.

OIL STOPPER

Oil stopper in cup prevents sudden oil spit.

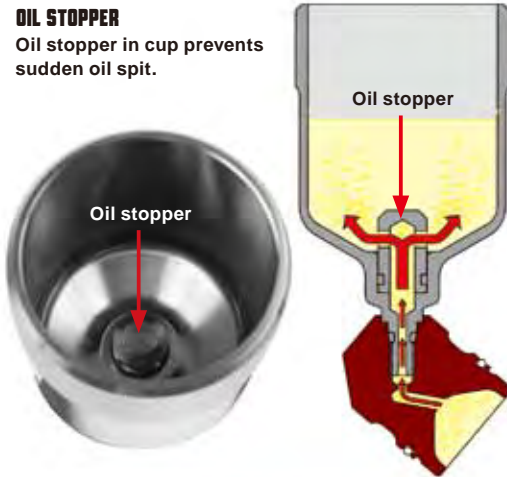

STAND



TRANSPORT



TOOL



CONTROL



EXHAUST



ELECTRICAL



DRIVE



BODY



ACCESSORIES



DRC GAS CAP EXTRACTOR

- Special tool for removing rear suspension gas cap.
- Does not damage gas cap valve thread.

Part number **D59-37-110**



Also useful if you pull out the top cap of the air front suspension.

DRC RCU SEAL HEAD INSERT KIT

- Seal guide for Rear suspension seal head.
- Does not damage oil seal during installing suspension seal.
- Comes with 3 different sizes, 14mm, 16mm and 18mm

Part number **D59-37-135**



Bolt **Spring hook** **Spring compressor Body**

DRC
SPRING COMPRESSOR

- Spring removal tool for twin shock motorcycles.
- 2 spring hooks hold the springs secure while compressing the springs, making it easy to remove the springs from the shock bodies.

Part number **D59-29-101**

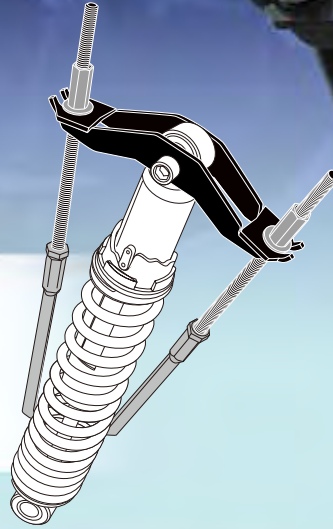

STAND



TRANSPORT



TOOL



DRC
FORK OIL SEAL REMOVER

- Using the principle of leverage, the fork seal removal tool makes removing fork seals easy.
- Won't scratch your front fork body. * Do not reuse oil seal.

Part number **D59-28-010**

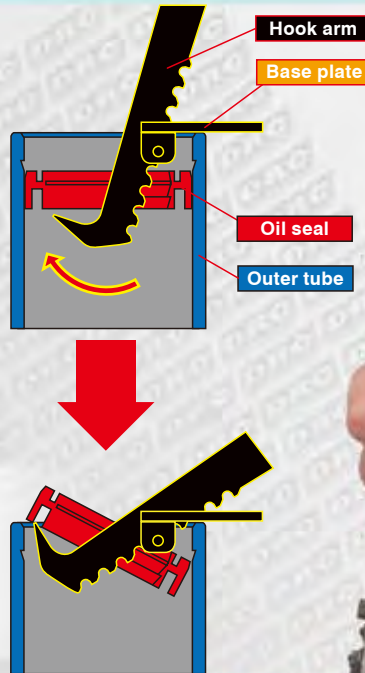

CONTROL



EXHAUST



ELECTRICAL



DRIVE



BODY



ACCESSORIES



DRC
STEERING STEM TOOL

- Wrench for steering stem nut.
- Can be used for all off-road and road bikes.
- Precision laser cut for accurate fit on most steering stem nut.
- 6 mm thickness to access stem nut without removing top triple clamp.
- Made of durable steel, electro coated finish with DRC sticker.

Part number **D59-12-112**

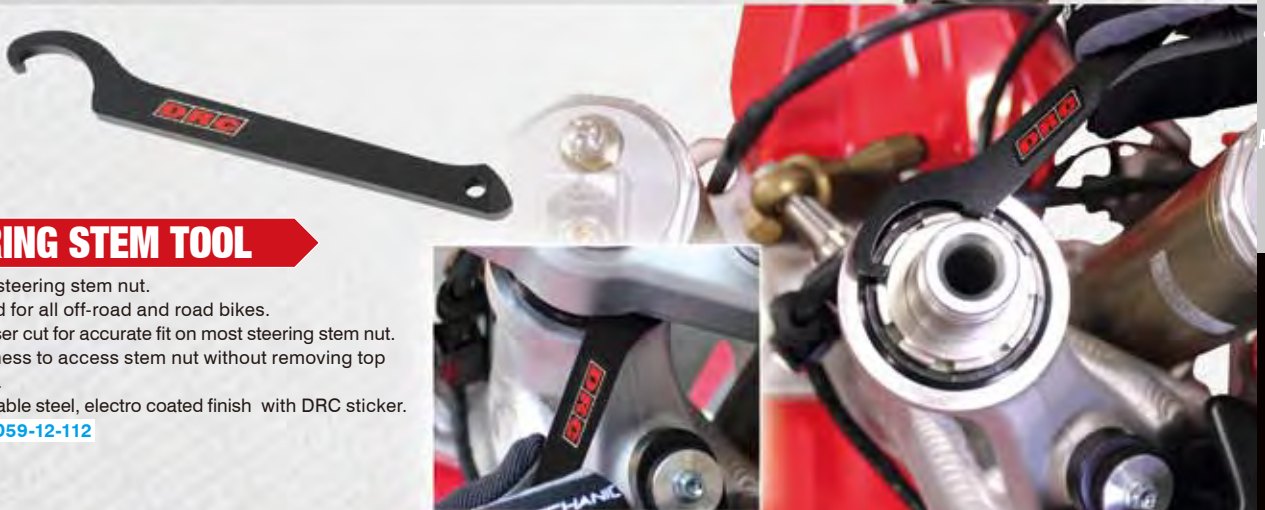

GYROSTAND SERIES

STAND



TRANSPORT



TOOL



CONTROL



EXHAUST



ELECTRICAL



DRIVE



BODY



ACCESSORIES



This special wheel tool makes your wheel truing and balancing easy. Build your own wheels with GYROSTAND.

PATENT PENDING



DRC GYRO STAND

- One stand works for truing, balancing wheels and checking bearings.
- Durable frame provides stability for accurate wheel truing and balancing.
- Accepts rim widths up to 5.0 inches, rim sizes up to 23 inches.
- Foldable design saves space.
- Use on wheels with bearing inner diameter of more than 15mm.

Part number **D36-52-110**

* Optional shaft set is required for bearing diameters less than 15 mm.

MXA RATING



Given its reasonable price, the DRC Gyro stand could pay for itself in a couple of do-it-yourself wheels-truing sessions.

HARDWARE
DRC

STAND



TRANSPORT



TOOL



CONTROL



EXHAUST



ELECTRICAL



DRIVE



BODY



ACCESSORIES



Wheel Truing Bearing Check



Lock wheel rod for wheel truing and bearing check.

Wheel Balance



Double bearing roller for wheel balancing.



Can be folded to a very compact size for storage.

DRC OPTIONAL 10 mm SHAFT SET

- For wheel bearings with inner diameters from 10 mm to 15 mm.

Part number **D36-52-191**



DRC GYRO EASY

- Simple wheel balancing, truing and bearing check kit.
- Light weight and compact design.
- Can be used on all motorcycle wheels.
- Can be used on wheels with bearing diameter of more than 15 mm.

Part number **D36-52-120**

* Optional shaft set is required for bearing diameters less than 15 mm.



Wheel Truing
Bearing Check

Wheel Balance



DRC PRO CHAIN TOOL

- Designed to break, press side plates and rivet most 420, 428, 520, 525 and 530 standard and O-ring chains.
- Light weight aluminum body.
- Straight forward parts construction.
- Conveniently store cut and rivet pins in the handle.
- Fits nicely in the tool box and no loose parts.
- Replacement cut pins and rivet pin available.

Part number
D59-16-112



Stored in handle



STAND



TRANSPORT



TOOL



REPLACEMENT PARTS

Replacement anvil set
Part number **D59-16-142**

Replacement cut pin set
Part number **D59-16-143**

Replacement rivet pin
Part number **D59-16-144**

DRC ALUMINUM CHAIN CUTTER

- Very compact chain cutter for 420 to 520 size chains.
- Compact design for easy storage.
- Chain cutter body is made of light weight aluminum.
- Cutting pin is made of durable chromoly.
- Available in 3 anodized colors, silver, black and blue.

Part number Color
D59-16-340 Silver
D59-16-351 Black
D59-16-352 Blue



Replacement pin
Part number **D59-16-333**

DRC CHAIN BRUSH

- Drive chain cleaning brush.
- " L " shaped brush easily cleans the chain.
- Aluminum tube handle designed for comfortable operation.
- Available in blue, red and titanium anodized handle colors.
- Replacement brushes available.

Part number Color
D59-22-001 Blue
D59-22-002 Red
D59-22-003 Titanium

Replacement brushes set

Part number
D59-22-990



CONTROL



EXHAUST



ELECTRICAL



DRIVE



BODY



ACCESSORIES





Gauge for Chain play



Extension ratio shown by percentage.



Can be used as gauge for chain play.



A. Lightly attach Chain checker on the chain roller.



B. Lower the measuring nib. Extension rate will be shown on measuring nib where it touches the chain roller.

DRG
CHAIN CHECKER

- Chain extension ratio checker. Very easy to check chain extension on your bike.
- Chain sizes from 420,428,520,525 and 530 can be checked.
- Chain play gauge is printed on the body.

Part number
D59-16-801

STAND



TRANSPORT



TOOL



CONTROL



EXHAUST



ELECTRICAL



DRIVE



BODY



ACCESSORIES



DRG
PRO SPOKE WRENCH

- Interchangeable tips to fit 8 sizes of spoke nipples.
- Main shaft is CNC precision machined from 7075A aluminum and designed for optimum grip.
- Tips are made of heat treated steel for strength.
- Available in 3 hard anodized colors.
- Standard and mini sizes available.



Tips Size 5.6 - 7.0 (Standard)
(5.6 / 5.8 / 6.0 / 6.2 / 6.4 / 6.6 / 6.8 / 7.0 mm)

Part number **Color**
D59-15-060 Titanium
D59-15-061 Red
D59-15-062 Blue

Tips Size 4.0 - 6.2 (Mini)
(4.0 / 4.4 / 5.0 / 5.2 / 5.6 / 5.8 / 6.0 / 6.2 mm)

Part number **Color**
D59-15-160 Titanium
D59-15-161 Red
D59-15-162 Blue

DRG
SPOKE WRENCH CRF50/DRZ50

- Spoke wrench for CRF/XR50, DRZ50/70 and KX65
- Tip size is 4.0 mm for stock CRF/XR50, DRZ50/70 and KX65 spoke nipples, 5.0mm size for after market spoke nipples.
- Made of durable steel.

Part number **Tips Size**
D59-15-900 4.0 mm & 5.0 mm



DRC OIL FILTER



- Replacement oil filters.
- Available for most of MX, ED, Supermoto and dual sport bikes.
- Filters impurities in engine oil for longer engine life.

Bike	Year	Part #
CRF150R	07-17	D58-80-1180
CRF250R	04-17	D58-80-1180
CRF450R	02-17	D58-80-1180
CRF450RX	17	D58-80-1180
CRF250L/M	12-16	D58-80-1177
XLR250	84-95	D58-80-1177
XLR250BAJA	88-95	D58-80-1177
XR250/BAJA/MOTARD	95-07	D58-80-1177
XR250R (ME06)	84-95	D58-80-1177
XR250R (ME08)	96-02	D58-80-1177
XR400MOTARD	05-08	D58-80-1177
XR400R	96-06	D58-80-1177
XR600R	88-02	D58-80-1177
XR650L	93-05	D58-80-1177
XR650R	00-05	D58-80-1177
AX-1	87-94	D58-80-1177
TLR250R	86	D58-80-1177
XL-DEGREE	91-95	D58-80-1177
GB250 Clubman	84-98	D58-80-1177
CBR250R	11-13	D58-80-1177

Bike	Year	Part #
KX250F	04-17	D58-80-1018
KX450F	06-17	D58-80-1177
KLX450R	08-15	D58-80-1177
KLX250R/SR/ES	93-16	D58-80-1177
D-TRACKER/X	98-16	D58-80-1177
SUPER SHERPA	97-07	D58-80-1177
KLX110	02-09	D58-80-1177
KLX110L	10-17	D58-80-1177
KLX125	10-16	D58-80-1177
D-TRACKER125	10-16	D58-80-1177
KLX300R	94-	D58-80-1177
KLE400	91-	D58-80-1177
KLX400	03-	D58-80-1801
EPSILON250	02-06	D58-80-1230
250TR	02-11	D58-80-1206
ESTRELLA	92-11	D58-80-1206

Bike	Year	Part #
250EXC Racing *	03-06	D58-80-1019
		D58-80-1014
400 SX/MXC/EXC *	99-02	D58-80-1019
		D58-80-1014
450 SX/EXC *	03-07	D58-80-1019
		D58-80-1014
520 SX/MXC/EXC *	99-02	D58-80-1019
		D58-80-1014
525 SX/MXC/EXC *	03-07	D58-80-1019
		D58-80-1014
250SX-F	07-12	D58-80-1019
250SX-F/XC-F	13-17	D58-80-1020
	07-13	D58-80-1019
250EXC-F/XCF-W	14-17	D58-80-1020
	14-17	D58-80-1014
350SX-F/EXC-F	11-17	D58-80-1020
350XC-F/XCF-W	11-17	D58-80-1020
FREERIDE350	12-17	D58-80-1020
450SX-F	07-12	D58-80-1020
	13-15	D58-80-1019
460SX-F/XC-F	16-17	D58-80-1020
	12-16	D58-80-1019
450EXC	12-16	D58-80-1019
450EXC-F	17	D58-80-1020
400/450/530EXC	08-11	D58-80-1020
500EXC	12-16	D58-80-1019
500EXC-F	17	D58-80-1020
500XC-W	12-16	D58-80-1019
TXC250	08-09	D58-80-1154
TXC450/510	08-10	D58-80-1154
TC/TE/250/450	02-09	D58-80-1154
FC250/FC350	14-17	D58-80-1020
	14-15	D58-80-1019
FC450	16-17	D58-80-1020
FE250/350	14-17	D58-80-1020
	14-16	D58-80-1019
FE450	17	D58-80-1020
	14-16	D58-80-1019
FE501	17	D58-80-1020
	17	D58-80-1020
FX350/450	17	D58-80-1020
TC/TE510	03-10	D58-80-1154
TE410E	98-01	D58-80-1154
TE610E	98-01/06-08	D58-80-1154
TE/SMS630	11	D58-80-1154
SM400R	04-05	D58-80-1154
SM450/510R	03-10	D58-80-1154
SM610	98-01/06-08	D58-80-1154
SM610S	00-01	D58-80-1154

* Need one of each



DRC AIR VALVE EXTENSION with HOSE

- Air valve extension with a hose.
- Easy to operate with flexible rubber hose.
- Hose length : 150 mm

Part number **D58-12-110**



DRC AIR VALVE EXTENSION

- Extension air valve changes the valve angle.
- Great for use on small wheel motorcycle, motard wheels with a big brake disc.
- For use with straight type air pump hose.

Part number **D58-12-100**



DRC TIMING PLUG WRENCH

- Wrench can be used for most motorcycle engine plugs.
- Comes with 4 different wrench sizes.
- Made of durable steel with black electro coating finish for less corrosion.
- Can be used for helmet viser screws.

Part number **D59-45-101**
Size W : 76 mm x H : 70 mm



DRC RELEASE TIE WRAP

- Releasable tie wrap, can be re-used.
- Length : 150 mm
- 6 pcs per pack.

Part number **D58-10-101**

STAND



TRANSPORT



TOOL



CONTROL



EXHAUST



ELECTRICAL



DRIVE



BODY



ACCESSORIES



DRC PLUG PROTECTOR

- Protects the plugs in your tool box.
- Available in 3 sizes.
- The clear cap allows you to identify the plug without opening.
- High-impact plastic construction

B-Type(14mm) Color
D58-14-016 Clear / Red

C-Type(10mm) Color
D58-14-215 Clear / Blue
D58-14-216 Clear / Red

D-Type(12mm) Color
D58-14-115 Clear / Blue
D58-14-116 Clear / Red
D58-14-117 Clear / Black

Plug Protector

Bike	Type	Bike	Type
HONDA			
CR65R/125R/250R	B	KX65/85/125/250	B
CRF150R	C	KX250F/450F	C
CRF250R/X	C	KLX110	C
CRF450R/X	B	KLX250/450R	C
XR50/100Motard	C	Super Sherpa	C
XR230	D	SUZUKI	
XR250/Motard	C	RM85/125/250	B
CRF250L/M	C	RMZ250/450	C
XR400Motard	D	Djebel250	C
XR650R	B	DRZ400	C
YAMAHA		KTM	
YZ85/125/250/250X	B	SX65/85/125/250	B
YZ250F/450F	C	SX-F250/450	C
WR250F/450F	C	EXC125/200/250	B
YZ250FX	C	EXC-F250	C
TT-R50E/125LWE	C	EXC-R400/450/525	D
WR250R/X	C	950SER	C
Serow225/250	D		

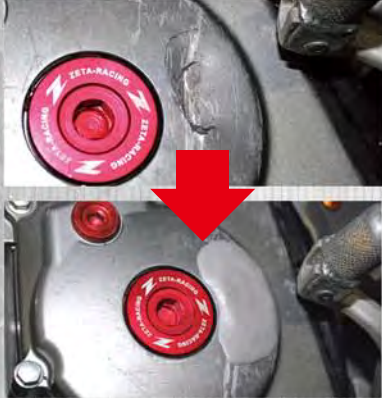

BONDS

- Aluminum
- Stainless
- Iron
- Plastic



DRC QUICK METAL

- Metal putty for motorcycles.
- Easy to use. Holds in 5 minutes, usable in 30 minutes, complete hardening in 24 hours.
- May be used on gas tank and crankcase.
- Can be drilled, sanded, tapped threaded, filed or painted after complete hardening.

Part number

D51-60-101 1pack

STAND



TRANSPORT



TOOL



CONTROL



EXHAUST



ELECTRICAL



DRIVE



BODY



ACCESSORIES

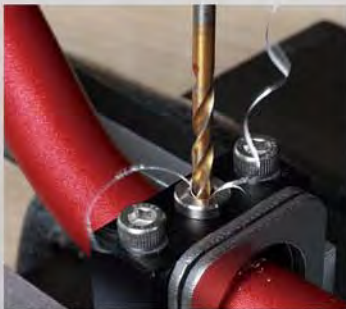
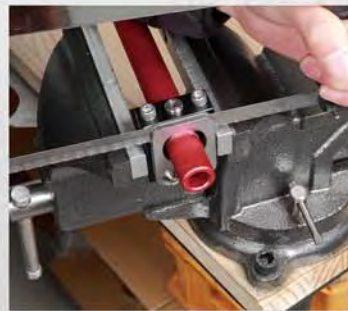

DRC HANDLEBAR SAW GUIDE

- Saw guide designed for easy to cut handlebar and throttle tube.
- Make your handlebar cut easy and vertically.
- Comes with 5mm hole drilling guide for handlebar.
- *Do not tighten too hard when you set this saw guide on throttle tube.
- *Do not use electric saw with this kit.

Part number **Cutting pipe size**
D59-45-211 From 22.2mm to 26mm



DRC OIL BOTTLE

- Portable 2stroke oil bottle.
- Easy to mix fuel for your 2 stroke at gas station.
- Measures 5cc and 30cc.
- Small enough to fit almost anywhere.

Part number
D59-44-020



DRC SPRING HOOK

- Easy exhaust spring removal.
- Excellent grip with the PVC coated handle.

Part number
D59-08-020



DRC WIRE OILER

- To inject lubricant into cable housing.
- Available in 3 hard anodized colors.

Part number **Color** **Replacement inner rubber**
D59-18-131 Titanium
D59-18-132 Red
D59-18-133 Black
Part number
D59-18-199



DRC STOCK REPLACEMENT LEVER

- Stock replacement brake and clutch levers.
- Available in standard and short length.
- MX, ED and dual sports models available.
- Sold Separately.



CLUTCH LEVER

Bike	Year	Std	Short
CR80R/85R	83-07	D40-01-102	D40-03-102
CRF150R	07-17	D40-01-102	D40-03-102
	86-03	D40-01-102	D40-03-102
CR125R	04-07	D40-01-101	-
	83-03	D40-01-102	D40-03-102
CR250R	04-07	D40-01-101	-
CRF250R	04-17	D40-01-101	-
CRF450R	02-03	D40-01-102	D40-03-102
	04-17	D40-01-101	-
CRF450RX	17	D40-01-101	-
CRF250X	04-17	D40-01-101	-
CRF450X	05-17	D40-01-101	-
CRF230F	03-09	D40-01-103	D40-03-103
CRM50/80	94-01	D40-01-102	D40-03-102
CRM250R/AR	94-98	D40-01-102	D40-03-102
CRF250L/M	12-16	-	D40-03-125
SL230	97-04	D40-01-103	D40-03-103
FTR	00-08	D40-01-103	D40-03-103
XL250	91-01	D40-01-103	D40-03-103
XLR125R	93-01	D40-01-103	D40-03-103
XLR200R	93-94	D40-01-103	D40-03-103
XR230/MOTARD	05-12	D40-01-103	D40-03-103
XR250/MOTARD/BAJA	95-07	D40-01-102	D40-03-102
XR400MOTARD	05-08	D40-01-102	D40-03-102
XR250RCM	96-99	D40-01-102	D40-03-102
XR250RDK	96-04	D40-01-102	D40-03-102
XR400RCM/DK	96-04	D40-01-102	D40-03-102
XR650RCM/DK	00-07	D40-01-102	D40-03-102
YZ80/85	80-14	D40-01-706	D40-03-706
	15-17	D40-01-709	-
	80-99	D40-01-706	D40-03-706
YZ125/250	00-14	D40-01-708	D40-03-708
	15-17	D40-01-709	-
YZ250F	01-08	D40-01-708	D40-03-708
	09-17	D40-01-709	-
YZ426F/450F	00-08	D40-01-708	D40-03-708
	09-17	D40-01-709	-
YZ400F	98-99	D40-01-706	D40-03-706
YZ125X	17	D40-01-709	-
YZ250X	16-17	D40-01-709	-
YZ250FX	15-17	D40-01-707	D40-03-707
YZ450FX	16-17	D40-01-707	D40-03-707
WR250F	05-17	D40-01-707	D40-03-707
WR450F	05-17	D40-01-707	D40-03-707
WR250Z	90-99	D40-01-706	D40-03-706
WR250R/X	07-17	D40-01-706	D40-03-706
SEROW225	86-16	D40-01-706	D40-03-706
/S/W/WE/250			
TTR125/LW/E	00-08	D40-01-706	D40-03-706
TTR250/RAID	93-07	D40-01-706	D40-03-706
XT250X	06-16	D40-01-706	D40-03-706
TRICKER	04-16	D40-01-706	D40-03-706
DR230LANZA	97-98	D40-01-706	D40-03-706
DT125	88-99	D40-01-706	D40-03-706
DT200R	88-90	D40-01-706	D40-03-706
DT200	87	D40-01-706	D40-03-706
DT50	88-96	D40-01-706	D40-03-706
TY250ZS	97	D40-01-706	D40-03-706
TY250Z	93-96	D40-01-706	D40-03-706
TW200/E/225E	91-08	D40-01-706	D40-03-706

Bike	Year	Std	Short
KX65	00-17	D40-01-509	-
	88-97	D40-01-706	D40-03-706
	98-17	D40-01-509	-
KX80/85/100	88-89	D40-01-706	D40-03-706
	90-05	D40-01-509	-
KX125	06-08	D40-01-708	D40-03-708
	90-04	D40-01-509	-
KX250	05-08	D40-01-708	D40-03-708
	04	D40-01-509	-
KX250F	05-17	D40-01-708	D40-03-708
KX450F	06-17	D40-01-708	D40-03-708
KLX450R	08-15	D40-01-707	D40-03-707
KDX125	90-99	D40-01-706	D40-03-706
KDX200	86-88	D40-01-706	D40-03-706
KDX200R	89-90	D40-01-706	D40-03-706
KDX200SR	89-93	D40-01-706	D40-03-706
KDX220R	94-95	D40-01-706	D40-03-706
KDX250R/SR	91-94	D40-01-706	D40-03-706
KLX125	10-16	D40-01-311	D40-03-311
/D-TRACKER125			
KLX150S	09-13	D40-01-311	D40-03-311
KLX250ES	94-97	D40-01-310	D40-03-310
KLX250R	93-95	D40-01-706	D40-03-706
KLX250SR	93-97	D40-01-706	D40-03-706
KLX300R	96	D40-01-706	D40-03-706
KLX250	98-07	D40-01-310	D40-03-310
/D-TRACKER			
KLX250	08-16	D40-01-311	D40-03-311
/D-TRACKER X			
SUPER SHERPA	97-07	D40-01-310	D40-03-310
RM85	05-16	D40-01-706	D40-03-706
RM125/250	89-08	D40-01-706	D40-03-706
	04	D40-01-509	-
RMZ250	05-06	D40-01-708	D40-03-708
	07-17	D40-01-509	-
RMZ450	05-17	D40-01-509	-
RMX250R/S	93-98	D40-01-706	D40-03-706
DRZ400R	00-04	D40-01-706	D40-03-706
DRZ400S/SM	00-16	D40-01-508	D40-03-508
DR250R	97-00	D40-01-508	D40-03-508
DR250S	90-94	D40-01-706	D40-03-706
	96-97	D40-01-706	D40-03-706
DJEBEL250XC	98-07	D40-01-508	D40-03-508
250SB	02-06	D40-01-310	D40-03-310
SX125/200	87-	D40-01-706	D40-03-706
TS50/125R/200R	89-97	D40-01-706	D40-03-706
TC85	14-17	D40-01-913	-
TC/TE/WR125-511			
brembo	-13	D40-01-912	-
TE250/300	14-16	D40-01-912	-
FC250-450	14-15	D40-01-912	-
FE250-501/S	14-16	D40-01-912	-
FR450RALLY	16-17	D40-01-912	-
FS450	15	D40-01-912	-

Bike	Year	Std	Short
65SX/XC	04-13	D40-01-911	D40-03-911
	14-16	D40-01-913	-
85SX/XC	04-12	D40-01-911	D40-03-911
	13-17	D40-01-913	-
105SX/XC	07-11	D40-01-911	D40-03-911
125EXC (SIX DAYS)	04-08	D40-01-911	D40-03-911
	05-08	D40-01-911	D40-03-911
125SX/XC-W/144SX	16-17	D40-01-912	-
150SX/XC/XC-W	16-17	D40-01-912	-
200EXC	03-08	D40-01-911	D40-03-911
	16	D40-01-912	-
200XC/XC-W	03-08	D40-01-911	D40-03-911
250EXC	03-05	D40-01-911	D40-03-911
/EXC-F (SIX DAYS)	06-17	D40-01-912	-
250EXC-R	03-05	D40-01-911	D40-03-911
250SX-F	05-06	D40-01-911	D40-03-911
	07-17	D40-01-912	-
250SX	03-05	D40-01-911	D40-03-911
	06-17	D40-01-912	-
250XC	06-17	D40-01-912	-
250XC-F/XCF-W	07-17	D40-01-912	-
250/300XC-W	06-17	D40-01-912	-
300EXC (SIX DAYS)	03-05	D40-01-911	D40-03-911
	06-17	D40-01-912	-
300XC	06-17	D40-01-912	-
350EXC-F/SIX DAYS	11-17	D40-01-912	-
350SX-F/XC-F/XCF-W			
400EXC	09-11	D40-01-912	-
400EXC-R	03-07	D40-01-911	D40-03-911
	07	D40-01-911	D40-03-911
400XC-W	09-10	D40-01-912	-
450EXC/R	04-06	D40-01-911	D40-03-911
/EXC-F (SIX DAYS)	07-17	D40-01-912	-
450RALLY REPLICA	13-14	D40-01-911	D40-03-911
	15-17	D40-01-912	-
450SMR	06-08	D40-01-911	D40-03-911
	13-14	D40-01-912	-
450SX/SX-F/SX-R	03-08	D40-01-911	D40-03-911
	13-17	D40-01-912	-
450XC	06-07	D40-01-911	D40-03-911
	08	D40-01-912	-
450XC-F	09	D40-01-911	D40-03-911
	13-17	D40-01-912	-
450XC-W	07	D40-01-911	D40-03-911
/XCR-W (SIX DAYS)	08-16	D40-01-912	-
500EXC/EXC-F			
/XC-W (SIX DAYS)	12-17	D40-01-912	-
505SX-F	08	D40-01-911	D40-03-911
	08	D40-01-912	-
505XC-F	09	D40-01-911	D40-03-911
	09	D40-01-912	-
525EXC-R	03-06	D40-01-911	D40-03-911
	07	D40-01-912	-
525SX/SX-R/XC/XC-W	03-07	D40-01-911	D40-03-911
530EXC/EXC-R			
/XCR-W/XC-W (SIX DAYS)	08-11	D40-01-912	-
FREERIDE 250R	14-17	D40-01-913	-
FREERIDE 350	12-17	D40-01-913	-
FREERIDE E-SX/XC/SM	15-16	D40-01-913	-

STAND



TRANSPORT



TOOL



CONTROL



EXHAUST



ELECTRICAL



DRIVE



BODY



ACCESSORIES



DRC TEAM GRIP

- Standard MX grip.
- 3 groove wiring system allows secure fastening.
- Closed and open end design are available.
- Open end design for easy installation of hand guards.
- Colors available: Black, Gray, Red and Blue.



CLOSED type



OPEN type



Color	CLOSED type	OPEN type	Color	CLOSED type	OPEN type
Black	D41-04-101	D41-04-201	Orange	D41-04-106	D41-04-206
Gray	D41-04-102	D41-04-202	Green	D41-04-105	D41-04-205
Red	D41-04-103	D41-04-203			
Blue	D41-04-104	D41-04-204			



D40-11-607

D40-11-811

D40-11-005

BRAKE LEVER

Bike	Year	STD	SHORT
CR80R/85R	98-07	D40-11-002	-
CRF150R	07-17	D40-11-002	-
CR125R/250R	92-07	D40-11-002	-
CRF250R	04-06	D40-11-002	-
	07-17	D40-11-005	-
CRF450R	02-06	D40-11-002	-
	07-17	D40-11-005	-
CRF450RX	17	D40-11-005	-
CRF250X	04-17	D40-11-002	-
CRF450X	05-17	D40-11-002	-
CRF125F	14-17	D40-11-002	-
CRF150F/230F	03-17	D40-11-002	-
XR230	05-12	D40-11-003	D40-13-003
CRF250L/M	12-16	D40-11-410	D40-13-410
XR250/MOTARD/BAJA	95-07	D40-11-003	D40-13-003
XR400MOTARD	05-08	D40-11-003	D40-13-003
XR250RCM	96-99	D40-11-002	-
XR250RDK	89-92	D40-11-003	D40-13-003
XR400RCM	96-04	D40-11-003	D40-13-003
XR400RDK	96-04	D40-11-002	-
XR400RDK	96-04	D40-11-003	D40-13-003
XR650RCM	00-07	D40-11-002	-
XR650RDK	00-07	D40-11-003	D40-13-003
CRM250/R/AR	89-98	D40-11-003	D40-13-003
CRM50/80	93-01	D40-11-003	D40-13-003
FTR	00-08	D40-11-003	D40-13-003
SL230	97-05	D40-11-003	D40-13-003
XL250	91-01	D40-11-003	D40-13-003
XLR125R	93-01	D40-11-003	D40-13-003
XLR200R	93-94	D40-11-003	D40-13-003
XLR250/BAJA	85-94	D40-11-003	D40-13-003
YZ80/85	87-96	D40-11-606	D40-13-606
	01-17	D40-11-607	-
YZ125	85-88	D40-11-606	D40-13-606
	01-07	D40-11-607	-
YZ250	08-17	D40-11-608	-
	85-87	D40-11-606	D40-13-606
YZ250F	01-07	D40-11-607	-
	08-17	D40-11-608	-
YZ250F	01-06	D40-11-607	-
	07-17	D40-11-608	-
YZ450F	01-07	D40-11-607	-
	08-17	D40-11-608	-
YZ125X	17	D40-11-608	-
YZ250X	16-17	D40-11-608	-
YZ250FX	15-17	D40-11-608	-
WR250F	01-17	D40-11-607	-
WR450F	01-17	D40-11-607	-
WR250R/X	07-17	D40-11-606	D40-13-606
SEROW225/S/W/WE/250	86-16	D40-11-606	D40-13-606
TTR250/RAID	93-07	D40-11-606	D40-13-606
XT250X	06-16	D40-11-606	D40-13-606
TRICKER	04-16	D40-11-606	D40-13-606
BRONCO	97-04	D40-11-606	D40-13-606
TW200/E/225E	91-08	D40-11-606	D40-13-606
DT230LANZA	97-98	D40-11-606	D40-13-606
DT200R	88-90	D40-11-606	D40-13-606
DT125R	88-97	D40-11-606	D40-13-606
DT200	87	D40-11-606	D40-13-606
TC/TE/WR125-511	-13	D40-11-811	-
TC85	14-17	D40-01-913	-
TC/TE/TX125-300	14-17	D40-11-812	-
FC/FE/FX250-501	14-17	D40-11-812	-

Bike	Year	STD	SHORT
KX65	00-17	D40-11-607	-
KX80	94-97	D40-11-002	-
KX85/100	00-17	D40-11-607	-
	94-96	D40-11-002	-
KX125	00-08	D40-11-607	-
	93-96	D40-11-002	-
KX250	00-08	D40-11-607	-
	04-12	D40-11-607	-
KX250F	13-17	D40-11-608	-
	06-12	D40-11-607	-
KX450F	13-17	D40-11-608	-
	10-16	D40-11-410	D40-13-410
KLX125,D-TRACKER125	09-13	D40-11-410	D40-13-410
KLX250/ES/SR/D-TRACKER	93-07	D40-11-409	D40-13-409
KLX250/D-TRACKER X	08-16	D40-11-410	D40-13-410
KLX300R	96	D40-11-002	-
KLX450R	08-09	D40-11-607	-
KDX250SR	92-94	D40-11-409	D40-13-409
KDX220SR	94-99	D40-11-003	D40-13-003
KDX125SR	90-99	D40-11-410	D40-13-410
RM85	05-16	D40-11-607	-
	96-03	D40-11-002	-
RM125/250	04-08	D40-11-607	-
	04-17	D40-11-607	-
RMZ250	05-17	D40-11-607	-
RMX450Z	10-16	D40-11-607	-
RMX250S	93-95	D40-11-409	D40-13-409
DRZ400S/SM	96-98	D40-11-408	D40-13-408
DR250R	00-16	D40-11-408	D40-13-408
DR250S	96-00	D40-11-408	D40-13-408
DR250S	90-94	D40-11-409	D40-13-409
250SB	02-06	D40-11-409	D40-13-409
DJEBEL250XC	96-07	D40-11-408	D40-13-408
DR200SE	93-00	D40-11-409	D40-13-409
DF200E	97	D40-11-409	D40-13-409
DR125SE	93-99	D40-11-409	D40-13-409
TS125/200	89-97	D40-11-409	D40-13-409
65SX	14-16	D40-01-913	-
85SX	13-17	D40-01-913	-
125SX/XC-W/EXC(SIX DAYS)	05-13	D40-11-811	-
144/150SX/150XC/XC-W		-	
200XC-W/EXC		-	
250SX/SX-F/XC/XC-F		-	
250XC-W/XCF-W	14-17	D40-11-812	-
250EXC/EXC-R/EXC-F (SIX DAYS)		-	
300XC/XC-W/EXC(SIX DAYS)	11-13	D40-11-811	-
350SX-F/XC-F/XCF-W		-	
350EXC-F(SIX DAYS)	14-17	D40-11-812	-
400XC-W/EXC/EXC-R	05-11	D40-11-811	-
450SX/SX-R/SX-F	05-13	D40-11-811	-
450XC/XC-F/XCR-W	14-17	D40-11-812	-
450XC-W/EXC-F/EXC/R (SIX DAYS)		-	
500XC-W/EXC/EXC-F (SIX DAYS)	12-13	D40-11-811	-
505SX-F/XC-F	14-17	D40-11-812	-
525SX/SX-R/XC/XC-W/EXC-R	08-09	D40-11-811	-
530XC-W/XCR-W/EXC-R/EXC	05-07	D40-11-811	-
450SMR	08-11	D40-11-811	-
FREERIDE 250R	13	D40-11-811	-
FREERIDE 350	14-17	D40-01-913	-
FREERIDE E-SX/XC/SM	12-17	D40-01-913	-
	15-16	D40-01-913	-

STAND



TRANSPORT



TOOL



CONTROL



EXHAUST



ELECTRICAL



DRIVE



BODY



ACCESSORIES



DRC HANDLEBAR EXTENSION

- Attach this extension on both sides of your handlebar to make your handlebar wider.
- Provides wider handlebar position without changing whole handlebar.
- One extension offers 10 mm or 15 mm of handlebar extended lengths.
- Can be used as bar end plug.
- Designed for aluminum handlebars.
- For use on handlebars with inside diameter of 13.5 mm to 14.5 mm .
- Comes in pairs.

DRC GRIP WIRE

- Wire for motorcycle grips.
- Made of SUS304 stainless steel for strength and corrosion prevention.
- Length : 2.5 m

Part number
D58-11-120

Part number
D41-01-001



DRC
EX PIPE GUARD 4 ST

- Universal exhaust pipe guard for 4 stroke bikes.
- Protect head pipe from stones and rocks.
- Guard body is made of A 5052 aluminum with titanium anodized finish.
- Easy to install with enclosed stainless pipe bands.
- Fits pipe diameter : 26 mm to 50 mm
- Flexible guard design, applicable on most recent 4 stroke dirt bikes.

Part number **Color**
D31-01-110 Titanium



DRC
EX PIPE GUARD 2 ST

- Universal exhaust pipe guards for 2 stroke bikes.
- Protect pipe from stones and rocks.
- Guard body is made of A 5052 aluminum with titanium anodized finish.
- Easy to install with enclosed stainless pipe bands.
- Flexible guard design, applicable on most recent 2 stroke dirt bikes.

Part number **Color**
D31-01-130 Titanium



DRC
HEAT PROTECTOR

- Oval design universal heat protector for 4 stroke exhaust head pipe.
- Made of stainless steel.
- Fits exhaust pipe diameters from 26 mm to 50 mm.
- Comes complete with all mounting hardware needed.

Part number **Replaced mount kit**
D31-02-201 **ZC31-3000**



DRC
HEAT SHIELD

- Protects plastic side panels, gas tank, radiator hoses, etc. from heat damage from exhaust or other hot parts.
- Flexible, cut to fit.
- Adhesive on one side and aluminum shielding on the other.

Part number
D31-03-112

Size
250 mm x 245 mm (10 " x 9.8 ") Thickness : 0.35 mm



STAND



TRANSPORT



TOOL



CONTROL



EXHAUST



ELECTRICAL



DRIVE



BODY



ACCESSORIES



Bike	Year	Part #
CRF150R	07-17	D31-41-010
CRF250R	04-13	D31-41-010
CRF250R(Front)	14-17	D31-41-010
CRF250X	04-17	D31-41-010
CRF450R	09-12	D31-41-020
CRF450R(Front)	13-16	D31-41-020
CRF450R(Rear)	13-16	D31-41-030
CRF250L/M	12-16	D31-41-060
XR250R	95-00	D31-41-010
XR400R	96-04	D31-41-010
XR230	05-12	D31-41-030
XLR250/BAJA	89-94	D31-41-040
XR250/MOTARD/BAJA	95-07	D31-41-050
XR400MOTARD	05-08	D31-41-050
YZ250F	06-13	D31-41-610
YZ450F	07-09	D31-41-620
YZ450F(Front)	10-13	D31-41-630
YZ450F(Rear)	14-17	D31-41-610
YZ450FX(Front)	10-13	D31-41-640
YZ450FX(Rear)	16-17	D31-41-610
WR250F	01-14	D31-41-630
WR450F	04-06	D31-41-610
WR450F	07-11	D31-41-630
WR450F	12-15	D31-41-610
WR450F(Front)	16	D31-41-610
WR250R/X	07-17	D31-41-650
SEROW225/S/W/WE/250	86-16	D31-41-660
TTR250/RAID	93-07	D31-41-040
XT250X	06-16	D31-41-660
TRICKER	04-16	D31-41-660
TW200/E/225E	91-08	D31-41-660

Bike	Year	Part #
KX250F	09-17	D31-41-210
KX450F	06-11	D31-41-220
KX450F	12-17	D31-41-210
KLX125/D-TRACKER125	10-16	D31-41-230
KLX150S	09-13	D31-41-230
KLX250/ES/SR/D-TRACKER	93-99	D31-41-240
KLX250/D-TRACKER	00-16	D31-41-250
RMZ250	07-09	D31-41-410
RMZ250	10-17	D31-41-420
RMZ450	08-17	D31-41-430
DRZ400S/SM	00-16	D31-41-010
DR250R	96-00	D31-41-440
250SB	02-06	D31-41-250
DR125SE/DF125	93-99	D31-41-440



DRC
EXHAUST JOINT GASKET

- Replacement exhaust joint gasket.
- Available for most Japanese dirt bikes.
- The same quality as OEM exhaust joint gasket.



DRC
STAINLESS EXHAUST CLAMP

- Stainless heavy duty exhaust clamp for 4 stroke bikes.
- Made of stainless steel for less corrosion than steel clamps.
- Available in 3 different sizes to fit most exhaust pipes.

Part number	Length
D31-32-360	Diameter 36 - 39 mm
D31-32-400	Diameter 40 - 43 mm
D31-32-440	Diameter 44 - 47 mm



DRC
SILENCER PLUG

- Double soft rubber ribs provides an excellent fit to keep water, bugs and dirt out of your exhaust system.
- Available in 2 different sizes, Black and Red handle colors.

L size	Color	Part number
(Exhaust opening size from 15 mm to 30 mm)	Black	D31-14-302
	Red	D31-14-304
L size	Color	Part number
(Exhaust opening size from 30 mm to 50 mm)	Black	D31-14-402
	Red	D31-14-404



DRC
PRO EXHAUST SPRING

- Quality replacement spring for your exhaust.
- One end of the spring swivels for a perfect fit.
- Available in 4 different lengths.
- Galvanized to prevent corrosion.
- 4 springs per pack.

Part number	Length
D31-31-157	57 mm (2.28 ")
D31-31-175	75 mm (3 ")
D31-31-183	83 mm (3.32 ")
D31-31-190	90 mm (3.6 ")



DRC
STANDARD EXHAUST SPRING

- Replacement exhaust springs.
- Available in 4 different lengths.
- Galvanized to prevent corrosion.
- 5 springs per pack.

Part number	Length
D31-31-057	57 mm (2.28 ")
D31-31-075	75 mm (3 ")
D31-31-083	83 mm (3.32 ")
D31-31-090	90 mm (3.6 ")

DRC
SILENCER REPACK KIT

- Silencer re-pack kit for all silencers.
- For both 2 stroke and 4 stroke.
- Size : 55 x 33 cm zzz = 12 mm
- Heat proof to 770 °C

Part number
D31-21-120



DRC
MAIN JET HOLDER

- Keep your main jets in your tool box.
- Made of PVC.
- Holds 12 pcs main jets.
- Compact size to fit in your tool box. (5 cm x 9 cm)

Part number	Color
D58-18-602	Blue



STAND



TRANSPORT



TOOL



CONTROL



EXHAUST



ELECTRICAL



DRIVE



BODY



ACCESSORIES



This series achieves ideal performance for off road models in all situations, making the most of LED characteristics in compact, energy-conserving and durable forms.



CRF250L/M

Red

Smoke

DRC MOTO LED
EDGE-2 TAIL LIGHT HOLDER
Steel for CRF250L/M

- Edge tail light holder kit designed for HONDA CRF250L/M.
- Comes with a bracket for the tail light, license plate and flashers.
- Has a compact design for sport riding.
- Tail light bracket is made of steel for extreme durability.
- Special oval bolt holes to easily adjust tail light upwards and downwards.
- Two different flasher holes for both OEM and 8 mm flashers.

Part number
[D45-18-507](#)
[D45-18-707](#)

Lens color
Smoke
Red

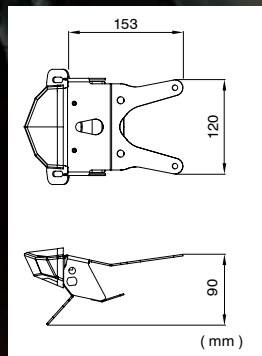

WR250R/X

Red

Smoke

DRC MOTO LED
EDGE-2 TAIL LIGHT HOLDER
Aluminum for WR250R/X

- Edge tail light holder kit designed for YAMAHA WR250R / X.
- Comes with tail light bracket, license plate bracket and flasher brackets.
- Shorter than OEM license brackets, provides cool looks and good center of mass.
- Special screw holes to enable proper setting of the tail lights.
- Flasher stay hole size : 8 mm

Part number
[D45-18-531](#)
[D45-18-731](#)

Lens color
Smoke
Red

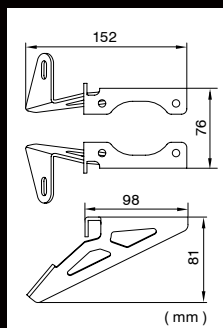

WR250R / X REPLACEMENT PARTS



Tail light bracket
Part number
[D45-18-130](#)



License plate stay
(With 8 mm hole flashers stay)
Part number
[D45-18-131](#)

STAND



TRANSPORT



TOOL



CONTROL



EXHAUST



ELECTRICAL



DRIVE



BODY



ACCESSORIES





Smoke

Red

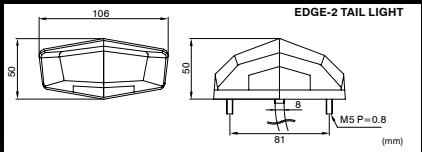

DRC
MOTO LED **EDGE-2 TAIL LIGHT**

- 16 high-intensity red LEDs are used for the tail / stop light, and 3 white LEDs for illuminating the license plate.
- Reduces electric power consumption. Offers a longer operating life.
- Detachable lens.
- Lens colors available: red and smoke.
- Plug type terminals are included for installation.
- Works on 12 V AC/DC.

Part number	Color	REPLACEMENT LENS	Part number	Color
D45-29-347	Red		D45-29-487	Red
D45-29-348	Smoke		D45-29-488	Smoke

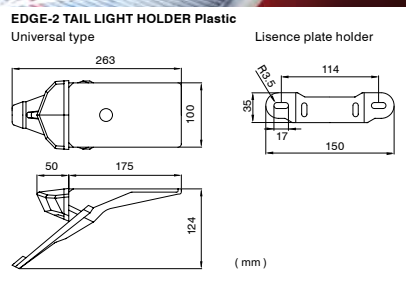
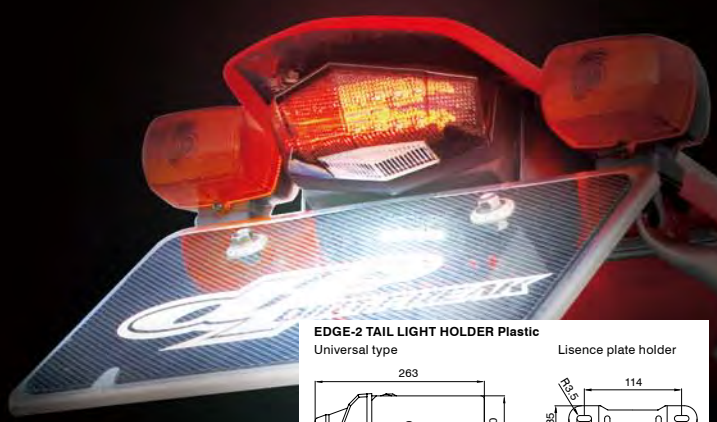

DRC
MOTO LED **EDGE-2 TAIL LIGHT HOLDER**
Plastic

- Universal plastic tail light holder with Edge tail light.
- Tail light holder is made of high quality, pliable plastic.
- Plastic material allows for quick and easy installation.
- Flashers can be placed on the flat side of this holder.
- Licence plate bracket (Japan specification) and plug type terminal included.
- Works on 12 V AC / DC.

Type	Part number	Lens color
Universal	D45-14-001	Red
	D45-14-002	Smoke



Red

Smoke

STAND



TRANSPORT



TOOL



CONTROL



EXHAUST



ELECTRICAL



DRIVE



BODY



ACCESSORIES

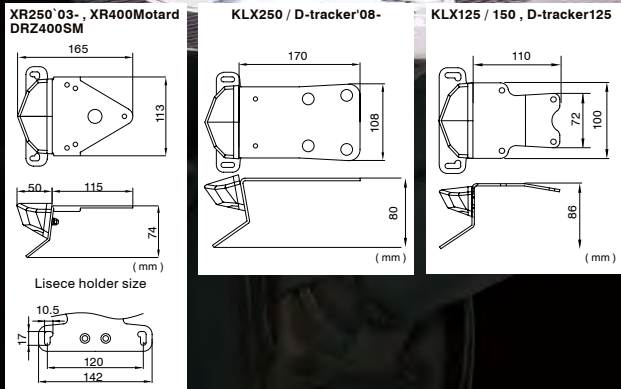

DRC
MOTO LED **EDGE-2 TAIL LIGHT HOLDER**
Aluminum

- Edge tail light with aluminum tail light holder designed for specific models.
- 16 high-intensity red LEDs are used for the tail / stop light, and 3 white LEDs for illuminating the license plate.
- Detachable lens.
- Comes with Flasher stays for DRC LED flashers.
- Plug type terminal included.
- Works on 12 V AC/DC.
- Reflector available. (Parts No [D45-07-899](#))

Type	Part number	Lens color
XR250'03- , XR400Motard	D45-18-704	Red
	D45-18-504	Smoke
DRZ400SM	D45-18-706	Red
	D45-18-506	Smoke
KLX250 / D-tracker-X '08-	D45-18-714	Red
	D45-18-514	Smoke
KLX125 / 150,D-tracker125	D45-18-715	Red
	D45-18-515	Smoke

DRC
MOTO LED **REFLECTOR**

- Universal reflector kit, especially perfect for DRC Edge tail light holders.
- Easily viewable, durable construction.
- Replacement reflector available.

Part number	Description
D45-07-899	(Kit)
D45-07-001	(Replacement reflector only)



DRC
MOTO LED ANATO ED REAR FENDER KIT

- Universal Enduro rear fender conversion kit with LED tail light.
- Fits on most MX type stock fenders.
- License plate bracket and plug type terminal included.
- Works on 12 V AC / DC.

Part number
D45-40-101

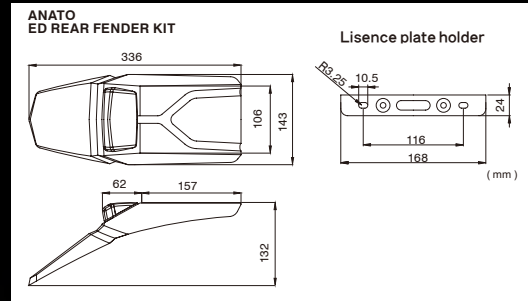

DRC
MOTO LED CRF-X TAIL LIGHT

- Fits CRF 250X / 450X.
- Tail light and stop light in this compact-sized product.
- Smaller and lighter than stock LED light.
- 8 high-intensity LEDs are used.
- Long operating life. Reduced electrical consumption.
- High impact, waterproofed, shock resistant.
- Lens colors available: red.
- Plug type terminals are included for installation.
- Works on 12 V AC / DC.

Part number **Color**
D45-29-330 Red



DRC
MOTO LED FLEX TAIL LIGHT

- Flex fit shell and body with 16 high quality chip LEDs.
- Even fits curved surfaces.
- Tail light and stop light in this compact-sized product.
- High impact, water and shock resistant.
- Includes aluminum bolts/nuts.
- Plug type terminals are included for installation.
- Works on 12 V AC / DC.
- Dimensions : L 109 mm x W 19 mm x H 9 mm.

Part number
D45-29-310

Flex-3

- Universal LED tail light.
- 12 pcs oval LEDs.
- Tail light and stop light in this compact-sized product.
- Reduced electric power consumption
- Works on 12 V AC / DC.
- Dimensions : L 109 mm x W 19 mm x H 19 mm

Part number
D45-29-316

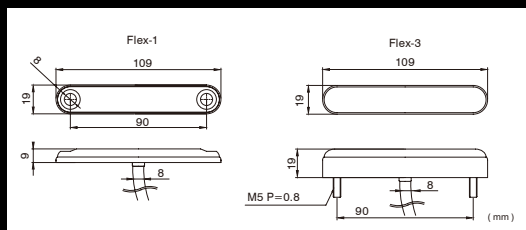

STAND



TRANSPORT



TOOL



CONTROL



EXHAUST



ELECTRICAL



DRIVE



BODY



ACCESSORIES



DRC
MOTO LED PHANTOM TAIL LIGHT

- High intensity LED light for the rear fender.
- Tail light base is made of flex rubber. Enables a great fit on all shapes of rear fenders with M 5 bolts.
- 8 high-intensity LEDs are used.
- Tail light and stop light in this compact- sized product.
- Plug type terminals are included for installation.
- Works on 12 V AC / DC.

Part number **Color**
D45-29-307 Red

Replacement lens	
Part number	Color
D45-29-387	Red

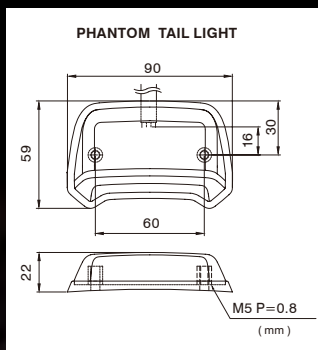

RALLY PATRIC TRAHAN CRF250L

STAND



TRANSPORT



TOOL



CONTROL



EXHAUST



ELECTRICAL



DRIVE



BODY



ACCESSORIES



DRC
MOTO LED LICENCE PLATE LIGHT

- Chip LED lights for licence plate.
- Very compact design, best for installing under the rear fender.
- Long operating life. Reduced electrical consumption.
- High impact, water and shock resistant.
- Works on 12 V AC / DC.
- Dimensions : L 50 mm x W 41 mm x H 3.5 mm.

Part number
D45-39-410

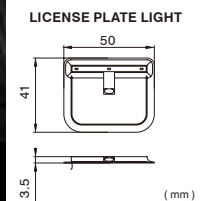

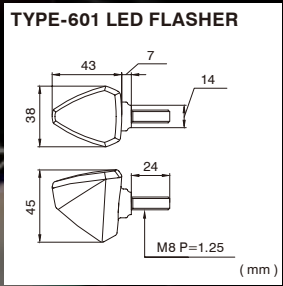
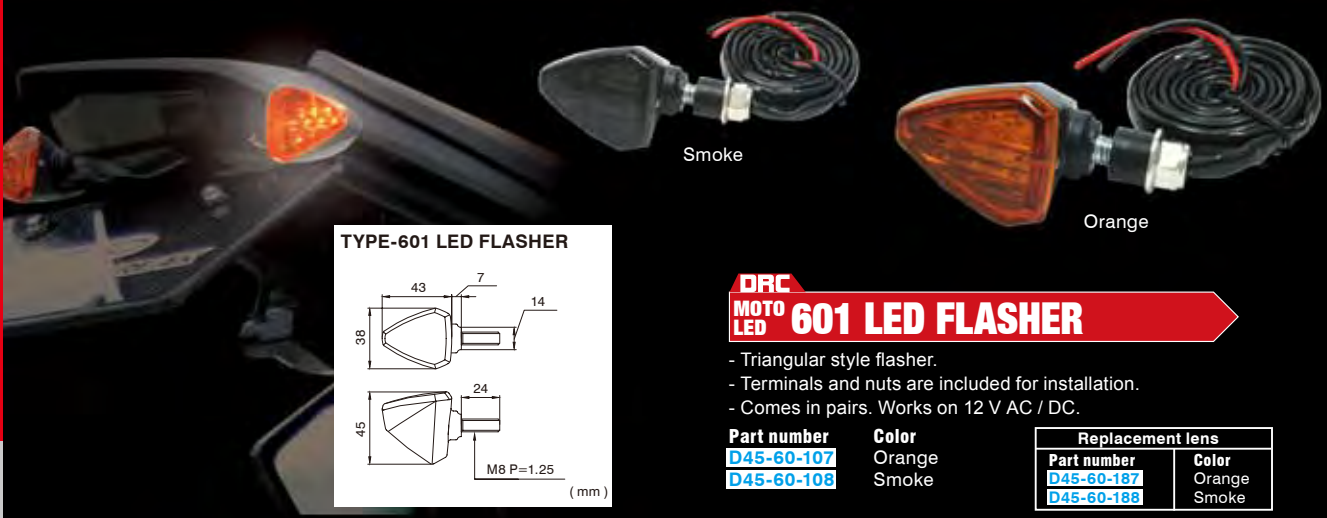

DRC MOTO LED 601 LED FLASHER

- Triangular style flasher.
- Terminals and nuts are included for installation.
- Comes in pairs. Works on 12 V AC / DC.

Part number
[D45-60-107](#)
[D45-60-108](#)

Color
 Orange
 Smoke

Replacement lens	
Part number	Color
D45-60-187	Orange
D45-60-188	Smoke



DRC MOTO LED 586 LED FLASHER

- Installs on the fender with screws for secure installation.
- Rubber mount base fits even curved surfaces.
- Terminals and bolts are included for installation.
- Comes in pairs. Works on 12 V AC / DC.

Part number **Color**
[D45-58-617](#) Orange
[D45-58-618](#) Smoke

Replacement lens	
Part number	Color
D45-58-687	Orange
D45-58-688	Smoke

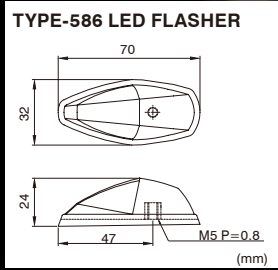

DRC MOTO LED FRONT FLASHER HOLDERS

- Flasher mounting hardware bolts to your top clamp.
- Screw hole is 8 mm in diameter.
- Available in 3 different types.



Type-9901
 Front fork tightening bolts : 1 pc, front side
Part number
[D45-59-901](#)

Type-9902
 Front fork tightening bolts : 2 pcs front side
 Bike: XR, CRM, RMX, KLX
 D-Tracker, 250SB etc
Part number
[D45-59-902](#)

Type-9912
 Front fork tightening bolts : 2 pcs side
 Bike : DRZ400, Tricker
Part number
[D45-59-912](#)

DRC MOTO LED FLASHER HOLDER PLATE

- Flasher mount adapter for Yamaha and Kawasaki OEM flasher mounting bracket.
- Use OE brackets with the plates to mount DRC LED flashers.
- Flasher attachment hole diameter : 8 mm
- Available in titanium and blue anodized colors.

Part number **Color**
[D45-59-950](#) Y / K Titanium 2 set
[D45-59-952](#) Y / K Blue 2 set
[D45-59-953](#) Y / K Black 2 set

Bike	Year
YAMAHA	
WR250R/X	07-
FZ1-N /-S	08-
YZF-R6	06-
YZF-R1	07-
MT-01	05-
KAWASAKI	
KLX125/D-TRACKER125	10-
KLX150	09-
KLX250/D-TRACKER X	08-
NINJA250R	08-





DRC MOTO LED 602 LED FLASHER

- Flexible flasher stays to prevent breakage upon impact.
- Lens colors available: orange, smoke and clear.
- Terminals and nuts are included for installation.
- Comes in pairs. Works on 12 V AC / DC.

Part number	Color	Replacement lens	
D45-60-207	Orange	Part number	Color
D45-60-208	Smoke	D45-60-287	Orange
D45-60-209	Clear	D45-60-288	Smoke
		D45-60-289	Clear

MOTO LED flashers may not work properly without optional parts.

DRC MOTO LED INDICATOR WIRING KIT



This kit is required when flasher operates like hazard indicators after the IC relay installation. Place these harnesses in-between the wires from the pilot lamp and the wires from the chassis.
 * Some models (*3) require this kit for proper operation.
 *3 ----- XR230, KSR110, KLX250, D-TRACKER-'07 etc.

Part number [D45-91-051](#)

DRC MOTO LED RESISTOR WIRE



When standard bulb flasher is replaced by LED flasher, electric consumption becomes low and stock flasher relay does not work correctly. This Resistor wire helps stabilize the electric power to the LED flasher from stock flasher relay.

- : Electric power consumption level is the same as with stock flasher.
- : Easy installation.
- : One resistor per flasher.
- * Some models (*2) require 2 resistors.
- : This harness will produce heat when used. Please install in areas where heat is not a problem.
- *2 ----- XR230, DR250R, DRZ400S/SM etc.

Part number [D45-90-710](#)

DRC MOTO LED IC RELAY for DC



Stock flasher relay is designed to work with standard bulb flashers. When the stock flasher is changed to LED flashers, the stock flasher relay does not work properly due to the difference in power consumption between the stock flasher bulb and the LED flasher. This IC Relay enables LED flashers to work in any configuration.

- * Some models require the use of the stock IC relay along with this IC relay. (*1)
- : Reduced electrical power usage.
- : Some technical skills required for installation.
- : One IC relay required for each bike.
- : Flasher pilot light can not be used with position light when installed on XR250.
- : If the flasher operates like hazard indicators after installation, Indicator lamp wiring kit is required.
- : Works on 12V DC.

Can not be used with WR250F/450F

*1----- RMX250S, DRZ400S/SM etc.

Part number [D45-69-830](#)

Installation of the LED flashers requires special knowledge and technique. Please contact your local dealer if you have any question upon installation.

Important note for using LED flasher

LED flashers have very low consumption and the stock flasher relay may not work properly. The most frequent problem, is that the LED may flash at a quick rate using stock flasher relays. Please refer to the chart below to choose our IC relay or Resistor wire for your installation.

	Electric consumption	Difficulty of installation	Parts cost	AC or DC
IC Relay	Low	Skills required	Cheap	DC
Resistor wire kit	Same as stock	Easy	Reasonable	DC/AC

* DRC IC Relay can not be used with motorcycles (XR50/100M, XLR250, WR250F/WR450F, XR650 etc) due to the AC power design. Please use Resistor wire kit for AC power motorcycle.

- STAND
- TRANSPORT
- TOOL
- CONTROL
- EXHAUST
- ELECTRICAL
- DRIVE
- BODY
- ACCESSORIES



DRC
MOTO LED
EZ ELECTRIC WIRE KIT

- Easy to install electrical parts (excluding headlight, tail light and flashers) for competition bikes.
- Easy installation. No experience necessary.
- Power source for this kit is completely self-contained (uses 8 AA batteries).
- No need to " chop " into your wiring harness.
- Moto LED's tail lights and flashers are recommended.

Part number D45-70-052

- Replacement Parts -

- A. D45-70-161** Main Harness
- B. D45-70-163** Flasher/Horn Switch
- C. D45-70-165** Main Switch
- D. D45-70-167** IC Horn
- E. D45-70-169** Battery Box
- F. D45-70-183** Oil Pressure Switch 1pk (M10-1.25)

DRC
MOTO LED
EZ ELECTRIC WIRE KIT
with ANATO / 601 Flasher

- Complete electrical parts (excluding headlight) for competition bikes.
- Comes with ANATO ED Rear Fender and 2 pairs of 601 Flashers.
- Easy installation. No experience necessary.
- Power source for this kit is completely self-contained (Uses 8 AA batteries).
- No need to " chop " into your wiring harness.

Part number D45-70-053

- G. D45-69-830** IC Relay for DC
- H. D45-40-101** Motoled Anato ED Rear Fender Kit
- I. D45-60-107** Motoled 601 LED Flasher

EASY INSTALLATION, ALL IN ONE ELECTRIC KIT!!

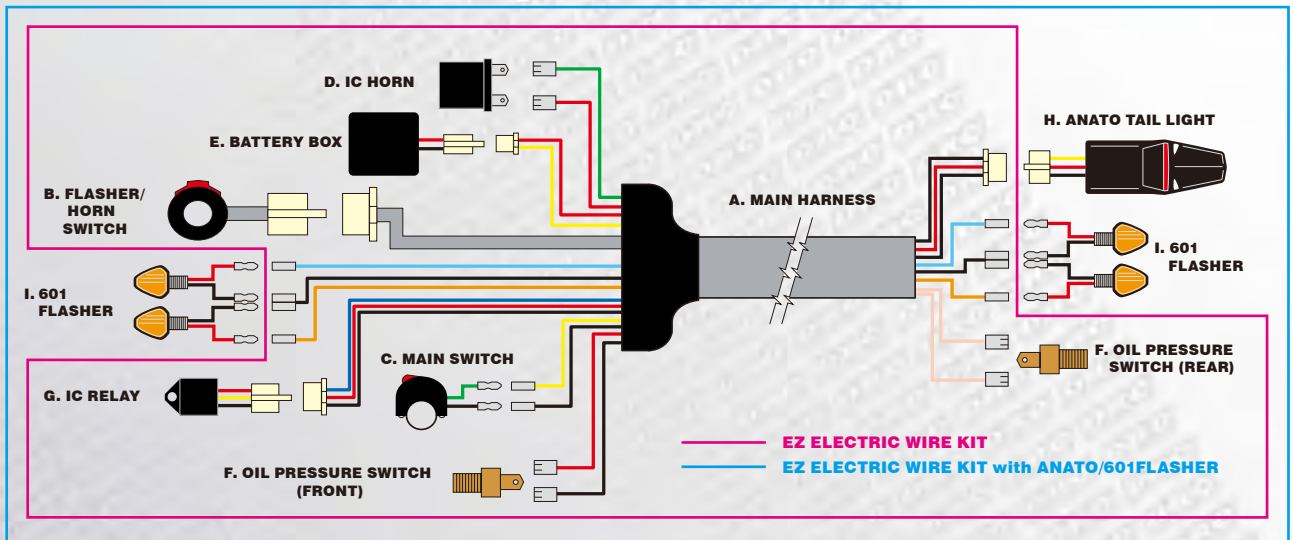

DRC
MOTO LED
OIL PRESSURE SWITCH

- Brake oil pressure switch for stop light.
- Made of light weight aluminum with compact design.
- Available in " bolt " or " banjo " type. Depending on your machine.
- Terminals are included for installation.

BANJO TYPE

- Part number**
D45-71-491 (M10-1.25)
D45-71-492 (M10-1.00)



BOLT TYPE

- Part number**
D45-71-481 (M10-1.25)
D45-71-482 (M10-1.00)



STAND



TRANSPORT



TOOL



CONTROL



EXHAUST



ELECTRICAL



DRIVE



BODY



ACCESSORIES



EZ BATTERY CHARGING KIT

No need to remove the battery for charging!

Easy to use !!

DRC EZ BATTERY CHARGING KIT

- Convenient when you store your bike for a long time.
- Terminal unit can be used for various kinds of battery chargers.
- No need to remove the battery when you connect the harness to the terminal unit.
- Easy operation. Just turn the battery charger on.
- Additional battery charging harness available. Part number: D45-01-002

Part number	Set	Battery charging harness only
D45-01-001	Battery charging harness Terminal Unit	D45-01-002

Terminal Unit



Battery charging harness



1
Install the battery charging harness to your bike.



2
Connect the battery charging connector and the terminal unit connector.



3
Connect battery charging clips to the terminal unit and start easy battery charging.





SUPER DURABLE
LIGHT WEIGHT
LONG LIFE

STAND



TRANSPORT



TOOL



CONTROL



EXHAUST



ELECTRICAL



DRIVE



BODY



ACCESSORIES



DURA
SPROCKET
デュラ スプロケット

DRC
DURA SPROCKET

- Made of durable heat treated steel that is stronger and longer lasting than aluminum sprockets.
- The best balanced, durable and light weight design. 30% lighter than standard steel sprockets available in the market.
- Precision laser cut for the lightest steel sprocket design.



DURA SPROCKET INSTALLATION APPLICATION



** Enter tooth number to complete part number when ordering.

	Bike	Year	Size	Part number	Tooth
HONDA	CR80R/85R	85-07	420	D34-01-0 **	46,47,48,49,50,51,55,56,57
	CRF150R	07-17	420	D34-01-0 **	46,47,48,49,50,51,55,56,57
	CR125R/250R	87-07			
	CRF150F/230F	03-17			
	CRF250R	04-17	520	D34-02-0 **	39,40,41,42,43,44,45,46,47,48,49,50,51,52,53
	CRF450R	02-16			
	CRF250X/450X	04-17			
	XR250R(ME06)	90-95	520	D34-03-0 **	39,40,42,44,45,46,48
	XR250R(ME08) XR400R	96-05	520	D34-02-0 **	39,40,41,42,43,44,45,46,47,48,49,50,51,52,53
	XR600R, XR650L	91-00	520	D34-03-0 **	39,40,42,44,45,46,48
	XR650R	00-07	520	D34-02-0 **	39,40,41,42,43,44,45,46,47,48,49,50,51,52,53
	CRM50/80	88-97	420	D34-01-0 **	46,47,48,49,50,51,55,56,57
	SL230	97-04			
	XR230	05-12	520	D34-02-0 **	39,40,41,42,43,44,45,46,47,48,49,50,51,52,53
	XR250/BAJA/Motard (MD30)	95-07	520	D34-02-0 **	39,40,41,42,43,44,45,46,47,48,49,50,51,52,53
	CRF250L/M	12-16	520	D34-03-0 **	39,40,42,44,45,46,48
	CRM250R	89-96	520	D34-03-0 **	39,40,42,44,45,46,48
	CRM250AR	97-98	520	D34-02-0 **	39,40,41,42,43,44,45,46,47,48,49,50,51,52,53
YAMAHA	YZ80/85	93-17	428	D34-31-0 **	46,47,48,49,50,51,52,53
	YZ125/250	85-98	520	D34-51-0 **	44,45,46,47,48,49,50,51
	YZ125/250	99-17			
	YZ250F-450F	99-17			
	YZ125X	17			
	YZ250X	16-17	520	D34-52-0 **	42,43,44,45,46,47,48,49,50,51,52
	YZ250FX	15-17			
	YZ450FX	16-17			
	WR250F	01-16			
	WR400F-450F	99-16			
	WR250	89-01	520	D34-51-0 **	44,45,46,47,48,49,50,51
	TDR50/80	88-	428	D34-53-0 **	49,54
	TTR125	02-16	428	D34-53-0 **	49,54
	DT125R/200R	-87	428	D34-53-0 **	49,54
	DT125R/200R DT230LANZA	88-	428	D34-54-0 **	53,55,57
	DT125R/200R DT230LANZA(428-520Combart)	#1 88-			
	DT200WR	#1 91-94	520	D34-51-0 **	44,45,46,47,48,49,50,51
	TT250R	#1 93-97	520	D34-51-0 **	44,45,46,47,48,49,50,51
TT250R Raid	94-96	428	D34-54-0 **	53,55,57	
TT250R Raid (428-520Combart)	#1 94-96	520	D34-51-0 **	44,45,46,47,48,49,50,51	
WR250R/X	#1 07-17	520	D34-52-0 **	42,43,44,45,46,47,48,49,50,51,52	
KAWASAKI	KX65	01-17	420	D34-20-0 **	46,47,48
	KX80/85/100	90-17	420	D34-22-0 **	49,50,51,52
	KX125/250	90-08			
	KX250F	04-17	520	D34-24-0 **	39,40,41,42,43,44,45,46,47,48,49,50,51,52,53
	KX450F	06-17			
	KLX450R	08-15			
	KLX125/D-TRACKER125	10-16			
	KLX150S	09-13	428	D34-25-0 **	44,47,49
	KDX125SR	90-99	428	D34-26-0 **	50,52,54
	KDX125SR (428-520Combart)	90-99			
SUZUKI	KDX200-250R/SR	89-	520	D34-24-0 **	39,40,41,42,43,44,45,46,47,48,49,50,51,52,53
	KLX250/300R/SR/ES	93-16			
	D-TRACKER	98-16			
	RM80/85	89-16	428	D34-31-0 **	46,47,48,49,50,51,52,53
	RM125/250	89-08	520	D34-32-0 **	40,41,42,43,44,45,46,47,48,49,50,51,52
	RM-Z250	04-06	520	D34-24-0 **	39,40,41,42,43,44,45,46,47,48,49,50,51,52,53
	RM-Z450	07-17	520	D34-32-0 **	40,41,42,43,44,45,46,47,48,49,50,51,52
	TS125R (428-520Combart)	05-17			
	TS200R	90-96	520	D34-32-0 **	40,41,42,43,44,45,46,47,48,49,50,51,52
	SX125R, DJEBEL125, DF125, DR125(428-520Combart)	89-			
	SX200R, DJEBEL200, DF200, DR200SE	-	520	D34-36-0 **	45
	RMX250S/R	89-98	520	D34-32-0 **	40,41,42,43,44,45,46,47,48,49,50,51,52
	DR250S/DJEBEL250	90-94	520	D34-33-0 **	41,42,43,44,45,46,47,48,49,50,51,52
	DR250R/DJEBEL250XC	95-08	520	D34-32-0 **	40,41,42,43,44,45,46,47,48,49,50,51,52
DRZ400R	00-05	520	D34-32-0 **	40,41,42,43,44,45,46,47,48,49,50,51,52	
DRZ400S(JAPAN)	00-03				
DRZ400S(US)	04-09	520	D34-33-0 **	41,42,43,44,45,46,47,48,49,50,51,52	
DRZ400SM #2(JAPAN)	00-16	520	D34-32-0 **	40,41,42,43,44,45,46,47,48,49,50,51,52	
DRZ400SM(US)	05-09	520	D34-33-0 **	41,42,43,44,45,46,47,48,49,50,51,52	
DRZ400SM(US)	05-16	520	D34-32-0 **	40,41,42,43,44,45,46,47,48,49,50,51,52	
K T M	85SX	03-17	428	D34-77-0 **	46,47,48,49,50
	125-690 SX/SXF/EXC/EXC-F/EXC-R/XC/XCW/SMR	91-17	520	D34-75-0 **	38,39,40,41,42,43,44,45,46,47,48,49,50,51,52
HUSABERG	350-650 FC/FE/FS	00-08	520	D34-75-0 **	38,39,40,41,42,43,44,45,46,47,48,49,50,51,52
	WR/CR/TE/TC/TX/SM/SMR 125-610	90-08	520	D34-33-0 **	41,42,43,44,45,46,47,48,49,50,51,52
HUSQVARNA	TC85	14-17	428	D34-77-0 **	46,47,48,49,50
	TC/TE/FC/FE/TX/FX 125-501	14-17	520	D34-75-0 **	38,39,40,41,42,43,44,45,46,47,48,49,50,51,52
GAS GAS	125-515(EC/FSR MC SM)	97-08	520	D34-33-0 **	41,42,43,44,45,46,47,48,49,50,51,52

#1 DRC Tapered bolts and nuts set are required for fitting
 #2 Singapore and Japan models use.

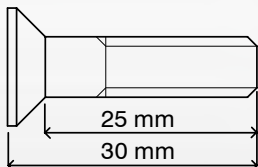

DRC SPROCKET BOLT / NUT SET

- Sprocket mounting hardware.
- Kit includes 6, 8 mm tapered bolts, 6 washers and 6 locking nuts.
- Can be used for most dirt bikes.

Part number D58-32-282
Bolt size M8 x 25 mm

STAND



TRANSPORT



TOOL



CONTROL



EXHAUST



ELECTRICAL



DRIVE



BODY



ACCESSORIES



DURA LIGHT

Bike	Year	Size	Part #	Tooth
HONDA				
CR125R	04-07	520	D331-549-**L	13
CR250R	88-07	520	D331-539-**L	13
CR500R	88-01	520	D331-539-**L	13
CRF150R	07-17	420	D331-307-**L	15
CRF250R	04-17	520	D331-549-**L	13
CRF250X	04-17	520	D331-549-**L	13
CRF450R	02-17	520	D331-539-**L	13
CRF450RX	17	520	D331-539-**L	13
CRF450X	05-17	520	D331-539-**L	13
TRX450	04-05	520	D331-539-**L	13
YAMAHA				
TTR50	06-16	420	D331-304-**L	13,14
TTR90	00-07	420	D331-304-**L	13,14
TTR110	08-16	420	D331-304-**L	13,14
MX90	74-75	428	D331-404-**L	13,14
MX/YZ125	74-76	428	D331-404-**L	13,14
YZ60	81-84	420	D331-304-**L	13,14
YZ80	81-01	428	D331-404-**L	13,14
YZ85	02-17	428	D331-412-**L	14
YZ125	05-17	520	D331-548-**L	13
YZ125X	17	520	D331-548-**L	13
YZ250	99-17	520	D331-530-**L	13
YZ250X	16-17	520	D331-530-**L	13
YZ250F	01-17	520	D331-548-**L	13
YZ250FX	15-17	520	D331-548-**L	13
YZ400F	98-99	520	D331-530-**L	13
YZ426F	00-02	520	D331-530-**L	13
YZ450F	03-17	520	D331-530-**L	13
YZ450FX	16-17	520	D331-530-**L	13
WR250F	01-16	520	D331-548-**L	13
WR250R/X	07-17	520	D331-548-**L	13
WR250Z	99-02	520	D331-530-**L	13
WR400F	98-99	520	D331-530-**L	13
WR426F	00-02	520	D331-530-**L	13
WR450F	03-16	520	D331-530-**L	13
AT1/AT125	70	428	D331-404-**L	13,14
CT1/CT175	70	428	D331-404-**L	13,14
DT1/DT250	68-78	520	D331-530-**L	13
DT125	74-81	428	D331-404-**L	13,14
DT125R	88-98	428	D331-412-**L	14
DT200R	88-90	428	D331-412-**L	14
DT230Lanza	97-98	428	D331-412-**L	14
DT400	75-	520	D331-530-**L	13
DT50LW(17W)	82-96	420	D331-304-**L	13,14
DT90	74-76	428	D331-404-**L	13,14
HT1/HT90	70	428	D331-404-**L	13,14
PW80	83-06	428	D331-304-**L	13,14
RT1/RT360/DT360	69-74	520	D331-530-**L	13
TDR125	89-	428	D331-412-**L	14
TDR250	91	520	D331-530-**L	13
TT500	76	520	D331-530-**L	13
TY125	76-89	428	D331-404-**L	13,14
TY175	77-80	428	D331-404-**L	13,14
XT500	76-81	520	D331-530-**L	13
RD125	74	428	D331-404-**L	13,14
TA125	73-74	428	D331-404-**L	13,14
KAWASAKI				
KX60	83-00	420	D331-304-**L	13,14
KX65	00-16	420	D331-304-**L	13,14
KX80/100	79-00	420	D331-304-**L	13,14
KX85/100	01-17	420	D331-304-**L	13,14
KX100	87	420	D331-304-**L	13,14
KX250	99-08	520	D331-530-**L	13
KX250F	06-17	520	D331-547-**L	13
KX450F	06-17	520	D331-530-**L	13
KLX450R	08-09		D331-530-**L	13
Ninja650/R	09-16	520	D331-530-**L	13
SUZUKI				
RM80	82-01	428	D331-404-**L	13,14
RM85	02-16	428	D331-404-**L	13,14
RM125	75	428	D331-404-**L	13,14
RMZ250	13-17	520	D331-524-**L	13
RMZ450	13-17	520	D331-541-**L	13
RA125	84	428	D331-404-**L	13,14
TM125	73-75	428	D331-404-**L	13,14
TS90	70	428	D331-404-**L	13,14
TS125	71-81	428	D331-404-**L	13,14
LT80	87-88	428	D331-404-**L	13,14
RV90	76-77	428	D331-404-**L	13,14
RV125	73-74	428	D331-404-**L	13,14
KTM				
KTM85SX	03-17	428	D331-411-**L	14
125-530SX	94-17	520	D331-537-**L	13,14
/EXC/XC/XC-W				
FREERIDE250R/350	12-17	520	D331-537-**L	13,14
HUSQVARNA				
TC85	14-17	428	D331-411-**L	14
125-501TC	14-17	520	D331-537-**L	13,14
/FC/TE/FE/TX/FX				
GASGAS				
200/250/350/400/450	97-13	520	D331-536-**L	13



DURA LIGHT Type

DRC DURA FRONT SPROCKET

- Front sprocket available from DRC, made of durable SCM420 steel.
- Great looking black zinc finish for corrosion resistance.
- Available front sprockets for most dirt bikes.
- Available lighter front sprocket design for recent racing models.

** Enter teeth number to complete part number when ordering.

DURA STD OTHER

Bike	Year	Size	Part #	Tooth
KTM				
125SX	98-17	520	D331-537-**	12,13,14,15
125XC	96-16	520	D331-537-**	12,13,14,15
125XC-W	17	520	D331-537-**	12,13,14,15
150SX	09-17	520	D331-537-**	12,13,14,15
150XC	10-14	520	D331-537-**	12,13,14,15
150XC-W	17	520	D331-537-**	12,13,14,15
200XC	97-16	520	D331-537-**	12,13,14,15
200XC-W	06-16	520	D331-537-**	12,13,14,15
250SX	94-17	520	D331-537-**	12,13,14,15
250XC	97-17	520	D331-537-**	12,13,14,15
250XC-W	06-17	520	D331-537-**	12,13,14,15
250XC-F	06-17	520	D331-537-**	12,13,14,15
250XC-F	07-17	520	D331-537-**	12,13,14,15
250XC-F	06-16	520	D331-537-**	12,13,14,15
300XC	96-17	520	D331-537-**	12,13,14,15
300XC-W	06-17	520	D331-537-**	12,13,14,15
350XC-F	11-17	520	D331-537-**	12,13,14,15
350XC-F	12-17	520	D331-537-**	12,13,14,15
350XC-F	11-17	520	D331-537-**	12,13,14,15
350XC-F	12-17	520	D331-537-**	12,13,14,15
450SX-F	07-17	520	D331-537-**	12,13,14,15
450XC	03-17	520	D331-537-**	12,13,14,15
450XC-F	08-17	520	D331-537-**	12,13,14,15
450XC-W	07-16	520	D331-537-**	12,13,14,15
500XC	12-17	520	D331-537-**	12,13,14,15
500XC-W	12-16	520	D331-537-**	12,13,14,15
530XC	08-11	520	D331-537-**	12,13,14,15
530XC-W	09-10	520	D331-537-**	12,13,14,15
FREERIDE250R	14-17	520	D331-537-**	12,13,14,15
FREERIDE350	12-17	520	D331-537-**	12,13,14,15
690ENDURO/R	08-16	520	D331-538-**	14,15,16
690DUKE	08-16	520	D331-538-**	14,15,16
690SMC/R	08-16	520	D331-538-**	14,15,16
HUSQVARNA				
TE250/350/400/510/610	90-08	520	D331-551-**	12,13,14,15,16
WR250	00-08	520	D331-551-**	12,13,14,15,16
WR360	00-08	520	D331-551-**	12,13,14,15,16
TC85	14-17	428	D331-411-**	13,14
TC125	14-17	520	D331-537-**	12,13,14,15
TC250	14-17	520	D331-537-**	12,13,14,15
FC250	14-17	520	D331-537-**	12,13,14,15
FC350	14-17	520	D331-537-**	12,13,14,15
FC450	14-17	520	D331-537-**	12,13,14,15
TE125	14-16	520	D331-537-**	12,13,14,15
TE150	17	520	D331-537-**	12,13,14,15
TE250	14-17	520	D331-537-**	12,13,14,15
TE300	14-17	520	D331-537-**	12,13,14,15
FE250	14-17	520	D331-537-**	12,13,14,15
FE350	14-17	520	D331-537-**	12,13,14,15
FE501	14-17	520	D331-537-**	12,13,14,15
TX125	17	520	D331-537-**	12,13,14,15
FX350	17	520	D331-537-**	12,13,14,15
FX450	17	520	D331-537-**	12,13,14,15
701 ENDURO	16	520	D331-538-**	14,15,16
GASGAS				
125EC	03-14	520	D331-535-**	13,14,15
200/250/350/400/450	97-13	520	D331-536-**	13

DURA STD SUZUKI

Bike	Year	Size	Part #	Tooth
DRZ70	08-16	428	D331-401-**	13,14
DRZ125	03-16	428	D331-413-**	14,15,16
JR50	80	420	D331-301-**	12,13,14,15
JR80	82-04	428	D331-401-**	13,14
RM80	77-81	428	D331-401-**	13,14
RM80	82-01	428	D331-404-**	13,14,15
RM85	02-16	428	D331-404-**	13,14,15
RM125	75	428	D331-404-**	13,14,15
RM125 520 Combart	75-79	520	D331-544-**	12,13
RM125	76-79	428	D331-414-**	13,14
RM125	80-08	520	D331-544-**	12,13
RM250	82-08	428	D331-523-**	12,13,14,15
RMZ250	04-06	520	D331-520-**	13
RMZ250	07-12	520	D331-544-**	12,13
RMZ250	13-17	520	D331-524-**	13,14
RMZ450	05-12	520	D331-540-**	13,14
RMZ450	13-17	520	D331-541-**	13,14
250S8	02-06	520	D331-532-**	13,14,15
DF125	97-	428	D331-413-**	14,15,16
DF200	97-	520	D331-525-**	14,15
Diebel125	93-	428	D331-413-**	14,15,16
Diebel200	93-04	520	D331-525-**	14,15
Diebel250	96	520	D331-523-**	12,13,14,15
DR/SP250	82-85	520	D331-526-**	13,14
DR/SP370	78-82	520	D331-526-**	13,14
DR125S	80-85	428	D331-414-**	13,14
DR250R	95-00	520	D331-523-**	12,13,14,15
DR250S/350S	90-93	520	D331-523-**	12,13,14,15
DR400	79-80	520	D331-526-**	13,14
DR500	81-83	520	D331-526-**	13,14
DR600	85-89	520	D331-516-**	16
DR650RSE	90-95	520	D331-516-**	16
DR750	88-89	520	D331-517-**	15
DR800	88-93	520	D331-517-**	15
DRZ400R/E/S/SM	00-16	520</		



DURA STD Type

** Enter teeth number to complete part number when ordering.

DURA STD YAMAHA

Bike	Year	Size	Part#	Tooth *
TTR50	06-16	420	D331-304-**-	12,13,14,15
TTR90	00-07	420	D331-304-**-	12,13,14,15
TTR110	08-16	420	D331-304-**-	12,13,14,15
TTR225	99-04	428	D331-406-**-	13,14,15,16
TTR230	05-15	520	D331-503-**-	13
MX90	74-75	428	D331-404-**-	13,14,15
MX/YZ125	74-76	428	D331-404-**-	13,14,15
YZ50	80	420	D331-301-**-	12,13,14,15
YZ60	81-84	420	D331-304-**-	12,13,14,15
	74-77	420	D331-301-**-	12,13,14,15
YZ80	78-80	428	D331-401-**-	13,14
	81-01	428	D331-404-**-	13,14,15
YZ85	02-17	428	D331-412-**-	13,14,15,16
	77-86	520	D331-501-**-	12,13
YZ125	87-04	520	D331-535-**-	13,14,15
	05-17	520	D331-548-**-	12,13,14
YZ125X	17	520	D331-548-**-	12,13,14
YZ175	76	520	D331-501-**-	12,13
YZ250	77-98	520	D331-513-**-	13,14,15,16
YZ250F	99-17	520	D331-530-**-	12,13,14
YZ250FX	16-17	520	D331-530-**-	12,13,14
YZ250F	01-17	520	D331-548-**-	12,13,14
YZ250FX	15-17	520	D331-548-**-	12,13,14
YZ2400F	98-99	520	D331-530-**-	12,13,14
YZ2426F	00-02	520	D331-530-**-	12,13,14
YZ2450F	03-17	520	D331-530-**-	12,13,14
YZ2450FX	16-17	520	D331-530-**-	12,13,14
WR125	98-02	520	D331-535-**-	13,14,15
WR200	81	520	D331-535-**-	13,14,15
WR250F	01-16	520	D331-548-**-	12,13,14
WR250R/X	07-17	520	D331-548-**-	12,13,14
WR250Z	89-98	520	D331-513-**-	13,14,15,16
	99-02	520	D331-530-**-	12,13,14
WR400F	98-99	520	D331-530-**-	12,13,14
WR426F	00-02	520	D331-530-**-	12,13,14
WR450F	03-16	520	D331-530-**-	12,13,14
AC200	85	428	D331-406-**-	13,14,15,16
AT1/AT125	70	428	D331-404-**-	13,14,15
BW200	85-88	520	D331-501-**-	12,13
BW350	87-88	520	D331-501-**-	12,13
CT1/CT175	70	428	D331-404-**-	13,14,15
DT1/DT250	68-78	520	D331-530-**-	12,13,14
	74-81	428	D331-404-**-	13,14,15
DT125	85-87	428	D331-405-**-	13,14,15,16
DT125R	88-98	428	D331-412-**-	13,14,15,16
DT125R 520 Combart	88-98	520	D331-535-**-	13,14,15
DT200R	88-90	428	D331-412-**-	13,14,15,16
DT200R 520 Combart	88-90	520	D331-535-**-	13,14,15
DT200WR	91-94	520	D331-535-**-	13,14,15
DT230Lanza 520 Combart	96	520	D331-535-**-	13,14,15
DT230Lanza 520 Combart	97-98	428	D331-412-**-	13,14,15,16
DT400	75	520	D331-530-**-	12,13,14
DT50LW(17W)	82-96	420	D331-304-**-	12,13,14,15
DT90	74-76	428	D331-404-**-	13,14,15
FT90	71	420	D331-301-**-	12,13,14,15
GT50	82	420	D331-301-**-	12,13,14,15
GT80	80	420	D331-301-**-	12,13,14,15
HT1/HT90	70	428	D331-404-**-	13,14,15
IT175	77-83	520	D331-501-**-	12,13
IT200	84-86	520	D331-501-**-	12,13
JT60	71	420	D331-301-**-	12,13,14,15
PW80	83-06	428	D331-304-**-	12,13,14,15
RT1/RT360/DT360	69-74	520	D331-530-**-	12,13,14
SEROW225	85-04	428	D331-406-**-	13,14,15,16
SEROW250	05-16	428	D331-412-**-	13,14,15
TDR125	88	428	D331-412-**-	13,14,15,16
TDR250	91	520	D331-530-**-	12,13,14
TRD50/80	88	428	D331-405-**-	13,14,15,16
TT250	86-87	520	D331-515-**-	14,15
TT250R	93-97	520	D331-550-**-	13,14
TT250Raid 520 Combart	94-96	520	D331-550-**-	13,14
TT350	86-92	520	D331-515-**-	14,15
TT500	76	520	D331-530-**-	12,13,14
TT600	83-92	520	D331-515-**-	14,15
TW125	99-05	428	D331-410-**-	14,15
TW200	87-01	428	D331-410-**-	14,15
TW225	02-07	428	D331-410-**-	14,15
TY125	76-89	428	D331-404-**-	13,14,15
TY175	77-80	428	D331-404-**-	13,14,15
TY250S/R	84-90	520	D331-512-**-	11,12
TY250Z	94	520	D331-535-**-	13,14,15
TY350R	85	520	D331-512-**-	11,12
TY50	75	420	D331-301-**-	12,13,14,15
TY80	76	420	D331-301-**-	12,13,14,15
XG250 Tricker	05-16	428	D331-415-**-	13,14,15
XT125R/X	08-11	428	D331-405-**-	13,14,15,16
XT250X	06-16	428	D331-415-**-	13,14,15
XT400	82	520	D331-515-**-	14,15
XT500	76-81	520	D331-501-**-	12,13,14
XT600Tenere	83-86	520	D331-515-**-	14,15
XTZ660Tenere	08-15	520	D331-534-**-	14,15
XTZ750 SuperTenere	90	520	D331-528-**-	16
YFS200 Blaster	88-06	520	D331-503-**-	13
Bronco	96	428	D331-406-**-	13,14,15,16
F81	70	420	D331-301-**-	12,13,14,15
F2400R	84-87	520	D331-515-**-	14,15
MT03	06-12	520	D331-534-**-	14,15
RD125	74	428	D331-404-**-	13,14,15
RD125	74-76	428	D331-405-**-	13,14,15,16
RD2125	82-86	428	D331-405-**-	13,14,15,16
TA125	73-74	428	D331-404-**-	13,14,15
TZR125	87-99	428	D331-405-**-	13,14,15,16
XJR400	93	520	D331-515-**-	14,15
YR950	87-92	420	D331-301-**-	12,13,14,15
YSR80	87-92	420	D331-301-**-	12,13,14,15

DURA STD Kawasaki

Bike	Year	Size	Part#	Tooth *
KX60/65/80/85/100 428 Combart	79	428	D331-407-**-	13,14,15
KX60	83-00	420	D331-304-**-	12,13,14,15
KX65	00-16	420	D331-304-**-	12,13,14,15
KX80/100	79-00	420	D331-304-**-	12,13,14,15
KX85/100	01-17	420	D331-304-**-	12,13,14,15
KX100	87	420	D331-304-**-	12,13,14,15
KX125	74-79	428	D331-405-**-	13,14,15,16
KX125	80-93	520	D331-501-**-	12,13
KX125	94-08	520	D331-509-**-	12,13,14,15
KX250	74-86	520	D331-514-**-	13,14
KX250	87-98	520	D331-513-**-	13,14,15,16
KX250	99-08	520	D331-530-**-	12,13,14
KX250F	04-05	520	D331-520-**-	13
KX250F	06-17	520	D331-547-**-	12,13,14
KX420	80-82	520	D331-514-**-	13,14,15
KX450F	06-17	520	D331-530-**-	12,13,14
KX500	83-86	520	D331-514-**-	13,14
KX500	87-04	520	D331-513-**-	13,14,15,16
KLX450R	08-09	520	D331-530-**-	12,13,14
125TR	71-73	428	D331-406-**-	14
175TR	71-73	428	D331-406-**-	14
250TR (F11) 520 Combart	73-76	520	D331-517-**-	15
250TR	02-14	520	D331-533-**-	14,15
350TR(F5) 520 Combart	71	520	D331-517-**-	15
AE50/80	81	420	D331-302-**-	12,13,14,15
D-Tracker/X	01-16	428	D331-532-**-	13,14,15
D-Tracker125	10-16	428	D331-416-**-	13,14
KD80	79-90	428	D331-405-**-	13,14,15,16
KD100	76-77	428	D331-405-**-	13,14,15,16
KD125	75-79	428	D331-405-**-	13,14,15,16
KD175	76-79	428	D331-405-**-	13,14,15,16
KDX125SR	90-99	428	D331-405-**-	13,14,15,16
KDX175	79-82	520	D331-501-**-	12,13
KDX200	83	520	D331-501-**-	12,13
KDX200	84-88	520	D331-513-**-	13,14,15,16
KDX200R	89-93	520	D331-513-**-	13,14,15,16
KDX200SR	89-93	520	D331-513-**-	13,14,15,16
KDX220R	94-05	520	D331-513-**-	13,14,15,16
KDX220SR	94-99	520	D331-513-**-	13,14,15,16
KDX250	82-85	520	D331-514-**-	13,14
KDX250R	91-94	520	D331-513-**-	13,14,15,16
KDX250SR	91-94	520	D331-513-**-	13,14,15,16
KDX400	79	520	D331-514-**-	13,14
KDX420	80-81	520	D331-514-**-	13,14
KDX450	82	520	D331-514-**-	13,14
KX60/100	76-81	428	D331-405-**-	13,14,15,16
KE125	74-83	428	D331-405-**-	13,14,15,16
KL250	79-83	520	D331-513-**-	13,14,15,16
KL250	93-95	520	D331-533-**-	14,15
KL400	91-99	520	D331-533-**-	14,15
KL500	01-07	520	D331-533-**-	14,15
KL750	84-05	520	D331-533-**-	14,15
KL800	84-86	520	D331-533-**-	14,15
KL8650R	89-16	520	D331-533-**-	14,15
KL1200	80-84	520	D331-514-**-	13,14
KL1250	82-84	520	D331-514-**-	13,14
KLX110	02-17	420	D331-302-**-	12,13,14,15
KLX125	10-16	428	D331-416-**-	13,14
KLX250	01-16	520	D331-532-**-	13,14,15
KLX250R	93-00	520	D331-513-**-	13,14,15,16
KLX250SR/ES	93-00	520	D331-513-**-	13,14,15,16
KLX300R	96-07	520	D331-513-**-	13,14,15,16
KM90/100	76-81	428	D331-405-**-	13,14,15,16
KMX125	86-89	428	D331-405-**-	13,14,15,16
KMX200	87-91	428	D331-405-**-	13,14,15,16
SuperSherpa	97-09	520	D331-513-**-	13,14,15,16
KXT250	84-86	520	D331-514-**-	13,14
A1 520 Combart	69	520	D331-517-**-	15
250SS 520 Combart	72	520	D331-517-**-	15
AR50	81	420	D331-302-**-	12,13,14,15
AR80	81	420	D331-302-**-	12,13,14,15
AR125	83	428	D331-405-**-	13,14,15,16
BJ250	520	520	D331-533-**-	14,15
CS250	85	520	D331-533-**-	14,15
EN500	96-00	520	D331-533-**-	14,15
EX500	520	520	D331-533-**-	14,15
GPX400R	520	520	D331-533-**-	14,15
GPZ400R	520	520	D331-533-**-	14,15
GPZ550	520	520	D331-533-**-	14,15
KH250 520 Combart	75-82	520	D331-517-**-	15
KR-1	88	520	D331-533-**-	14,15
KV75	75	420	D331-301-**-	12,13,14,15
Ninja250R	08-17	520	D331-532-**-	13,14,15
Ninja250SL	15-16	520	D331-532-**-	13,14,15
Ninja650R	09-16	520	D331-532-**-	12,13,14
Z250	13-16	520	D331-532-**-	13,14,15
Z250SL	16	520	D331-532-**-	13,14,15
ZXR6	03-06	520	D331-529-**-	14,15
ZXR400	520	520	D331-533-**-	14,15

DURA STD HONDA

Bike	Year	Size	Part#	Tooth *
CR50/60	83-86	420	D331-303-**-	13,14,15
	80-85	420	D331-303-**-	13,14,15
CR80R	86-02	420	D331-308-**-	13,14,15
CR85R	03-07	420	D331-308-**-	13,14,15
CR125M	74-78	428	D331-408-**-	13,14,15,16,17
	79-85	5		

DRC CHAIN ROLLER

- More durable than stock
- Available in 3 diameter sizes.
- Colors available: black, blue and red.

S size (32 mm)

Part number	Color
D47-41-341	Black
D47-41-342	Blue
D47-41-343	Red

L size (42 mm)

Part number	Color
D47-41-441	Black
D47-41-442	Blue
D47-41-443	Red

M size (36 mm)

Part number	Color
D47-41-641	Black
D47-41-642	Blue
D47-41-643	Red

Upper	Lower
CR125R/250R 04- CRF250R/X,CRF450R/X 04- KX250F/450F 07- KLX450R 08- CR125R/250R 05- CRF250R 05-,CRF250X 06- CRF450R/X 05- KX250F/450F 07- KLX450R 08-	

S size

M size

L size



STAND



TRANSPORT



TOOL



CONTROL



EXHAUST



ELECTRICAL



DRIVE



BODY



ACCESSORIES



DRC RIM LOCK

- Die-cast aluminum body with molded rubber flap to prevent abrasion of inner tube.
- Recommended for use on all off road bikes or any use that requires low tire pressures.
- Bolt is made of SUS304 stainless steel to prevent corrosion.
- Available in 5 different sizes.

Part number	Size
D43-21-014	1.40 inch
D43-21-016	1.60 inch
D43-21-018	1.85 inch
D43-21-021	2.15 inch
D43-21-025	2.50 inch

DRC RIM HOLE PLUG

- Plug cap for rim lock holes on the rim.
- Prevents mud and dust from entering the tyre through the rim lock hole.
- Comes in pairs.

Part number
[D58-03-301](#)

DRC AIR VALVE CAP WITH VALVE WRENCH

- The aluminum part can be used as a valve core remover / wrench.
- Made of A6061 aluminum.
- Available in 6 beautiful anodized colors.
- Comes in pairs.

Part number	Color	Part number	Color
D58-05-101	Silver	D58-05-104	Black
D58-05-102	Blue	D58-05-105	Titanium
D58-05-103	Gold	D58-05-106	Red

DRC AIR VALVE CAPS PLASTIC 4 PCS

- Plastic air valve cap.
- Available in 4 factory colors.
- Comes in 2 pairs and 2 colors.

Part number	Color
D58-03-211	Blue & Green
D58-03-212	Red & Yellow

DRC AIR VALVE CAPS

- Aluminum air valve cap.
- Add some "bling" to your bike.
- Available in 6 beautiful anodized colors.
- Comes in pairs.

Part number	Color	Part number	Color
D58-03-102	Blue	D58-03-105	Titanium
D58-03-103	Gold	D58-03-106	Red
D58-03-104	Black	D58-03-107	Orange

DRC AIR VALVE MUD GUARDS

- Keeps dirt and water out of your tire.
- Available in black, blue, red and orange.
- Comes in pairs.

Part number	Color	Part number	Color
D58-06-001	Black	D58-06-003	Red
D58-06-002	Blue	D58-06-007	Orange

DRC RIM LOCK SPACERS

- Form fit provides a secure, tighter fit over stock set-up.
- Made of aluminum and available in 6 beautiful anodized colors.
- Comes in pairs.

Part number	Color	Part number	Color
D58-01-102	Blue	D58-01-105	Titanium
D58-01-103	Gold	D58-01-106	Red
D58-01-104	Black	D58-01-107	Orange

DRC RIM LOCK NUTS

- Threaded at the top only. Takes less time to remove or tighten.
- Made of aluminum and available in 6 beautiful anodized colors.
- Comes in pairs.

Part number	Color	Part number	Color
D58-02-102	Blue	D58-02-105	Titanium
D58-02-103	Gold	D58-02-106	Red
D58-02-104	Black	D58-02-107	Orange

SMJ SUPAR MOTO
IKKI MORITA

STAND



TRANSPORT



TOOL



CONTROL



EXHAUST



ELECTRICAL



DRIVE



BODY



ACCESSORIES



Bike	Year	Part #
HONDA		
CRF150R	07-16	D48-02-932
CR125/250	02-07	D48-02-932
CRF250R	04-17	D48-02-932
CRF250X	04-17	D48-02-932
CRF450R	02-17	D48-02-932
CRF450RX	17	D48-02-932
CRF250L/M	12-16	D48-02-932
XR250R	95-04	D48-02-924
SuperXR250/Baja	95-02	D48-02-924
XR250/MOTARD	03-07	D48-02-924
YAMAHA		
YZ85	02-17	D48-02-906
YZ125/250	99-17	D48-02-906
YZ250F-450F	99-17	D48-02-906
YZ125X	17	D48-02-906
YZ250X	16-17	D48-02-906
YZ250FX	15-17	D48-02-906
YZ450FX	16-17	D48-02-906
WR250F	01-16	D48-02-906
WR400F-450F	99-16	D48-02-906
WR250R / X	07-17	D48-02-937
KAWASAKI		
KX250F/450F	09-17	D48-02-931
KLX250/300/D-Tracker	-16	D48-02-922
SUZUKI		
RM125/250	91-02	D48-02-921
RM-Z250	10-17	D48-02-920
RM-Z450	08-09	D48-02-905
	10	D48-02-920
RMX450Z	12-17	D48-02-920
	10-16	D48-02-920
RMX250R	89-99	D48-02-921
RMX250S	93-99	D48-02-921
DR-Z400R/S/SM	00-16	D48-02-921
KTM		
125SX/250-450SX-F	98-15	D48-02-910
	16-17	D48-02-982
250SX	98-16	D48-02-910
	17	D48-02-982
125-530 EXC/EXC-F	98-16	D48-02-910
	17	D48-02-982
150-300XC/250XC-F	06-16	D48-02-910
	17	D48-02-982
350-450XC-F	08-15	D48-02-910
	16-17	D48-02-982
125-530XC-W/XCF-W	06-16	D48-02-910
	17	D48-02-982
950SUPER ENDURO	ALL	D48-02-910
990ADVENTURE	ALL	D48-02-910
HUSQVARNA		
WR125,TE250,SM250	07-09	D48-02-981
	14-15	D48-02-910
TC125/FC 250-450	16-17	D48-02-982
	14-16	D48-02-910
TC250	17	D48-02-982
	14-16	D48-02-910
TE/FE125-501	17	D48-02-982
TX/FX125-450	17	D48-02-982



DRC
MOTARD FOOT PEG

- Equipped with replaceable peg slider for super moto riding.
- Shorter length, higher peg position prevents peg body worn by avoiding hitting asphalt.
- 50 mm step width provides better grip and control.
- Made of chromium molybdenum steel for extreme durability.
- Black powder coating finish.
- Replacement peg slider available.

EQUIPPED PEG SLIDER



DRC
REPLACEMENT PEG SLIDER

Comes in pairs.
4 screws for attachment are included.
Part number
D48-02-999



Wide Foot Peg Spring 2pcs
(YZ/WR250F/450F'06-,YZ125/250'06-)
D48-02-006

DRC
WIDE FOOT PEG

- Durable steel wide foot pegs.
- Made of chromium molybdenum steel for extreme durability.
- 50mm step width provides better grip and control.
- Mid, High (5 mm higher than medium peg position) and Low (5 mm lower than medium peg position) are available for rider's body type or use.
(Excluding some models.)
- Black powder coating finish.



JMX TEAM REDZONE
YUTA IKEGAYA

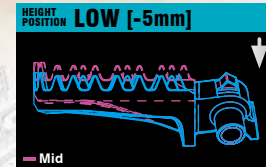
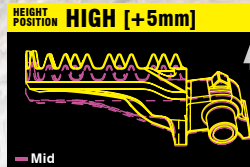

High
High gravity point allows for easy lean on the bike.
Good for shorter riders.

Low
Low gravity point provides better traction during standing ride.
Good for taller riders.

Bike	Year	Low (-5)	Mid	High (+5)
CRM50/80	ALL	-	D48-02-542	-
CRF110F	13-16	-	D48-02-533	-
CRF125F	14-17	-	D48-02-533	-
CRF150R	07-17	-	D48-02-532	D48-02-632
CR125/250	02-07	-	D48-02-532	D48-02-632
CRF250R	04-17	-	D48-02-532	D48-02-632
CRF250X	04-17	-	D48-02-532	D48-02-632
CRF450R	02-17	-	D48-02-532	D48-02-632
CRF450X	05-17	-	D48-02-532	D48-02-632
XR/CRF50/70	00-17	D48-02-408	D48-02-508	-
CRF230F	03-17	-	D48-02-503	-
XR230	05-13	-	D48-02-534	-
CRF250L/M	12-16	-	D48-02-532	D48-02-632
CRF1000L	16	-	D48-02-534	-
CRM250R/AR	91-98	-	D48-02-524	-
XR250R(ME08)	95-04	-	D48-02-524	-
SuperXR250/Baja	95-02	-	D48-02-524	-
XR250/MOTARD	03-07	-	D48-02-524	-
XLR250R	87-94	-	D48-02-541	-
XR400R	96-04	-	D48-02-534	-
XR600R	92-00	-	D48-02-534	-
XR650L	92-16	-	D48-02-534	-
XR650R	00-07	-	D48-02-534	-
Y285	02-17	D48-02-406	D48-02-506	D48-02-606
YZ125/250	99-17	D48-02-406	D48-02-506	D48-02-606
YZ250F	01-16	D48-02-406	D48-02-506	D48-02-606
	17	-	D48-02-406	D48-02-506
YZ450F	03-15	D48-02-406	D48-02-506	D48-02-606
	16-17	-	D48-02-406	D48-02-506
YZ125X	17	D48-02-406	D48-02-506	D48-02-606
YZ250X	16-17	D48-02-406	D48-02-506	D48-02-606
YZ250FX	15-17	-	D48-02-406	D48-02-506
YZ250FX	16-17	-	D48-02-406	D48-02-506
WR250F	01-06	D48-02-406	D48-02-506	D48-02-606
	07-16	-	D48-02-406	D48-02-506
WR400F-450F	99-15	D48-02-406	D48-02-506	D48-02-606
	16-17	-	D48-02-406	D48-02-506
WR250R / X	07-17	D48-02-437	D48-02-537	D48-02-637
SEROW225	95-04	-	D48-02-536	-
SEROW250/Tricker	04-16	-	D48-02-535	-
DT200WR	ALL	-	D48-02-535	-
DT230LANZA	97-98	-	D48-02-535	-
TT250R/RAID	93-97	-	D48-02-535	-
KLX110	02-17	D48-02-451	D48-02-551	-
KX65/80/85/100	98-17	-	D48-02-523	-
KX125-250	91-96	-	D48-02-526	-
KX250F/450F	09-17	D48-02-431	D48-02-531	D48-02-631
KLX125, D-TRACKER125	10-16	-	D48-02-507	-
KDX125SR	90-99	-	D48-02-561	-
KLX150S	09-13	-	D48-02-507	-
KDX200R/SR	89-93	-	D48-02-561	-
KDX220R/SR	ALL	-	D48-02-526	-
KDX250R/SR	ALL	-	D48-02-526	-
KLX250/300/D-Tracker	-16	-	D48-02-522	-

Bike	Year	Low (-5)	Mid	High (+5)
RM85	02-16	-	D48-02-561	-
RM125/250	91-02	-	D48-02-521	-
RM-Z250	07-09	-	D48-02-504	-
	10-17	D48-02-420	-	D48-02-620
	08-09	-	D48-02-505	D48-02-605
RM-Z450	10	D48-02-420	D48-02-520	D48-02-620
	12-17	D48-02-420	D48-02-520	D48-02-620
RMX450Z	10-16	D48-02-420	D48-02-520	D48-02-620
DR-Z50/70	08-13	D48-02-451	D48-02-551	-
TS125R	89-97	-	D48-02-535	-
TS200R	89-96	-	D48-02-535	-
RMX250R	89-99	-	D48-02-521	-
RMX250S	93-99	-	D48-02-521	-
DJEBEL250/250XC	ALL	-	D48-02-507	-
DR250/350S/R	ALL	-	D48-02-507	-
DR-Z400R/S/SM	00-16	-	D48-02-521	-
65SX	09-17	D48-02-410	D48-02-510	D48-02-610
85SX	03-17	D48-02-410	D48-02-510	D48-02-610
	98-15	D48-02-410	D48-02-510	D48-02-610
125SX/250-450SX-F	16-17	D48-02-482	D48-02-582	D48-02-682
	98-16	D48-02-410	D48-02-510	D48-02-610
250SX	17	D48-02-482	D48-02-582	D48-02-682
125-530 EXC/EXC-F	98-16	D48-02-410	D48-02-510	D48-02-610
250-500 EXC/EXC-F	17	D48-02-582	D48-02-682	-
150-300XC/250XC-F	06-16	D48-02-410	D48-02-510	D48-02-610
	17	D48-02-482	D48-02-582	D48-02-682
350-450XC-F	08-15	D48-02-410	D48-02-510	D48-02-610
	16-17	D48-02-482	D48-02-582	D48-02-682
200-530XC-W/XCF-W	06-16	D48-02-410	D48-02-510	D48-02-610
125-300XC-W	17	D48-02-582	D48-02-682	-
950SUPER ENDURO	ALL	D48-02-410	D48-02-510	D48-02-610
990ADVENTURE	ALL	D48-02-410	D48-02-510	D48-02-610
FREERIDE250R	14-17	D48-02-410	D48-02-510	D48-02-610
FREERIDE350	12-17	D48-02-410	D48-02-510	D48-02-610
WR125,TE250,SM250	07-09	D48-02-481	D48-02-581	D48-02-681
TC85	14-17	D48-02-410	D48-02-510	D48-02-610
	14-15	D48-02-410	D48-02-510	D48-02-610
TC125/FC 250-450	16-17	D48-02-482	D48-02-582	D48-02-682
	14-16	D48-02-410	D48-02-510	D48-02-610
TC250	17	D48-02-482	D48-02-582	D48-02-682
TE/FE125-501	14-16	D48-02-410	D48-02-510	D48-02-610
TE/FE150-501	17	D48-02-582	D48-02-682	-
TX125	17	D48-02-582	D48-02-682	-
TX/FX300-450	17	D48-02-482	D48-02-582	D48-02-682

Wide Foot Peg Spring 2 pcs
(YZ/WR250F/450F'06-,YZ125/250'06-)
D48-02-006



STAND



TRANSPORT



TOOL



CONTROL



EXHAUST



ELECTRICAL



DRIVE



BODY



ACCESSORIES





	Bike	Year	Part#	
H	CRF150R	07-17	D48-02-832	#1
	CR125R/250R	02-07	D48-02-832	#1
	CRF250R	04-17	D48-02-832	#1
	CRF250X	04-17	D48-02-832	#1
	CRF450R	02-17	D48-02-832	#1
	CRF450RX	17	D48-02-832	#1
	CRF450X	05-17	D48-02-832	#1
	CRF250L/M	12-16	D48-02-832	
Y	YZ125/250	99-17	D48-02-806	
	YZ250F	01-16	D48-02-806	
		17	D48-02-806	#1
	YZ450F	03-15	D48-02-806	
		16-17	D48-02-806	#1
	YZ125X	17	D48-02-806	
	YZ250X	16-17	D48-02-806	
	YZ250FX	15-17	D48-02-806	#1
	YZ450FX	16-17	D48-02-806	#1
	WR250F	01-06	D48-02-806	
K	WR400F-450F	07-16	D48-02-806	
		99-15	D48-02-806	
		16-17	D48-02-806	#1
	KX250F/450F	09-17	D48-02-831	
S	RM-Z250	10-17	D48-02-820	
		10	D48-02-820	
	RM-Z450	12-17	D48-02-820	
	RMX450Z	10-16	D48-02-820	

#1 OEM+5mm

	Bike	Year	Part#	
K	65SX	09-17	D48-02-810	
	85SX	03-17	D48-02-810	
	125SX/250-450SX-F	98-15	D48-02-810	
		16-17	D48-02-882	
	250SX	98-16	D48-02-810	
		17	D48-02-882	
	125-530 EXC/EXC-F	98-16	D48-02-810	
	125-500 EXC/EXC-F	17	D48-02-882	#2
	150-300XC/250XC-F	06-16	D48-02-810	
		17	D48-02-882	
Y	350-450XC-F	08-15	D48-02-810	
		16-17	D48-02-882	
	200-530XC-W/XCF-W	06-16	D48-02-810	
	125-300XC-W	17	D48-02-882	#2
	950SUPER ENDURO	ALL	D48-02-810	
	990ADVENTURE	ALL	D48-02-810	
	FREERIDE250R	14-17	D48-02-810	
	FREERIDE350	12-17	D48-02-810	
	TC85	14-17	D48-02-810	
	TC125/FC 250-450	14-15	D48-02-810	
	16-17	D48-02-882		
S	TC250	14-16	D48-02-810	
		17	D48-02-882	
	TE/FE125-501	14-16	D48-02-810	
	TE/FE150-501	17	D48-02-882	#2
	TX125	17	D48-02-882	#2
	TX/FX300-450	17	D48-02-882	

#2 OEM-5mm



DRC
ULTRA WIDE FOOTPEG

- Wider foot pegs than our DRC foot pegs for pro use.
- 57 mm width foot pegs provides better foot peg traction and control.
- Made of chromium molybdenum steel for extreme durability.
- Black powder coating finish.



YZ250X



YZ250X

DRC
SIDE STAND HOOK

- Hold your side stand with durable rubber band in hard riding.
- Prevents wear of stand attachment area.

YAMAHA	Year	Part #
YZ125/250	05-17	D48-10-041
YZ125X	17	D48-10-041
YZ250X	16-17	D48-10-041
YZ250FX	15-17	D48-10-042
WR250R/X	07-17	D48-10-043

Replacement rubber
D48-10-099

STAND



TRANSPORT



TOOL



CONTROL



EXHAUST



ELECTRICAL



DRIVE



BODY



ACCESSORIES



DRC ALUMINUM BOLT

- Made of 7009 aluminum.
- Light weight.
- Select from flange-head or taper-head for each bolt size.
- Suitable for mounting plastics and more.
- Colors available: Titanium, Gold, Red and Blue.
- Available in M6 size.
- Sold in set of 4 and 20.
- Tightening torque M6 Bolts.....6N /m



M6 Flange Bolt

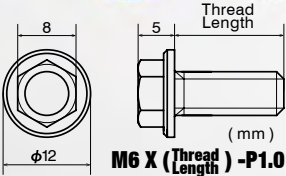

M6 Taper Bolt

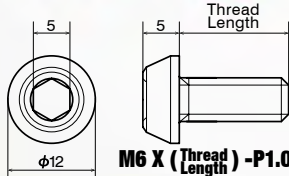

DRC ALUMINUM NUT

- Made of 7009 aluminum.
- Light weight.
- Suitable for mounting plastics and more.
- Colors available: Titanium, Gold, Red and Blue.
- Available in M6 size.
- Sold in set of 4 and 20.

M6 Flange Nut

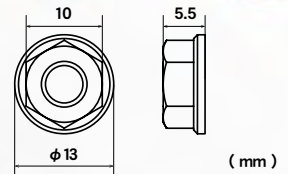

M6 Aluminum Flange Bolt			
Color	Size	4 pack	20 pack
Blue	M6X12-P1.0	D58-51-112	D58-51-612
	M6X16-P1.0	D58-51-116	D58-51-616
	M6X20-P1.0	D58-51-120	D58-51-620
	M6X25-P1.0	D58-51-125	D58-51-625
	M6X30-P1.0	D58-51-130	D58-51-630
	M6X35-P1.0	D58-51-135	D58-51-635
Red	M6X12-P1.0	D58-51-212	D58-51-712
	M6X16-P1.0	D58-51-216	D58-51-716
	M6X20-P1.0	D58-51-220	D58-51-720
	M6X25-P1.0	D58-51-225	D58-51-725
	M6X30-P1.0	D58-51-230	D58-51-730
	M6X35-P1.0	D58-51-235	D58-51-735
Gold	M6X12-P1.0	D58-51-312	D58-51-812
	M6X16-P1.0	D58-51-316	D58-51-816
	M6X20-P1.0	D58-51-320	D58-51-820
	M6X25-P1.0	D58-51-325	D58-51-825
	M6X30-P1.0	D58-51-330	D58-51-830
	M6X35-P1.0	D58-51-335	D58-51-835
Titanium	M6X12-P1.0	D58-51-412	D58-51-912
	M6X16-P1.0	D58-51-416	D58-51-916
	M6X20-P1.0	D58-51-420	D58-51-920
	M6X25-P1.0	D58-51-425	D58-51-925
	M6X30-P1.0	D58-51-430	D58-51-930
	M6X35-P1.0	D58-51-435	D58-51-935

M6 Aluminum Taper Bolt			
Color	Size	4 pack	20 pack
Blue	M6X12-P1.0	D58-52-112	D58-52-612
	M6X16-P1.0	D58-52-116	D58-52-616
	M6X20-P1.0	D58-52-120	D58-52-620
	M6X25-P1.0	D58-52-125	D58-52-625
	M6X30-P1.0	D58-52-130	D58-52-630
	M6X35-P1.0	D58-52-135	D58-52-635
Red	M6X12-P1.0	D58-52-212	D58-52-712
	M6X16-P1.0	D58-52-216	D58-52-716
	M6X20-P1.0	D58-52-220	D58-52-720
	M6X25-P1.0	D58-52-225	D58-52-725
	M6X30-P1.0	D58-52-230	D58-52-730
	M6X35-P1.0	D58-52-235	D58-52-735
Gold	M6X12-P1.0	D58-52-312	D58-52-812
	M6X16-P1.0	D58-52-316	D58-52-816
	M6X20-P1.0	D58-52-320	D58-52-820
	M6X25-P1.0	D58-52-325	D58-52-825
	M6X30-P1.0	D58-52-330	D58-52-830
	M6X35-P1.0	D58-52-335	D58-52-835
Titanium	M6X12-P1.0	D58-52-412	D58-52-912
	M6X16-P1.0	D58-52-416	D58-52-916
	M6X20-P1.0	D58-52-420	D58-52-920
	M6X25-P1.0	D58-52-425	D58-52-925
	M6X30-P1.0	D58-52-430	D58-52-930
	M6X35-P1.0	D58-52-435	D58-52-935

M6 Aluminum Flange Nut			
Color	size	4 pack	20 pack
Blue	M6-P1.0	D58-53-101	D58-53-601
Red	M6-P1.0	D58-53-201	D58-53-701
Gold	M6-P1.0	D58-53-301	D58-53-801
Titanium	M6-P1.0	D58-53-401	D58-53-901

DRC ALUMINUM SPACER

- Made of forged 6061 Aluminum, light weight.
- Available ϕ 18mm M6 and ϕ 20mm M6 washer sizes.
- Suitable for mounting plastics and more.
- Available in 4 different designs and 5 different anodized colors.
- ϕ 18 mm M6 spacers are sold in sets of 4 and 20.
- ϕ 20 mm M6 spacers are sold in sets of 10.



Type 01 (M6 18 mm)

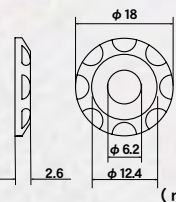

Type 02 (M6 18 mm)

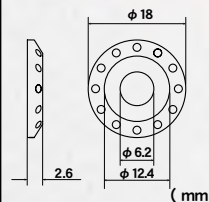

Type 11 (M6 18 mm)

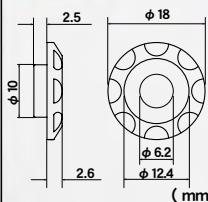

Type 12 (M6 18 mm)

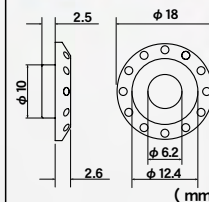

Type 31 (M6 20 mm)

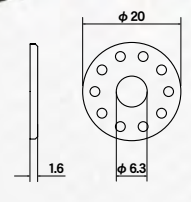

ϕ 18 M6 Aluminum Spacer			
Color	Size	4 Pack	20 Pack
Blue	Type01	D58-57-111	D58-57-114
Red		D58-57-121	D58-57-124
Gold		D58-57-131	D58-57-134
Titanium	Type02	D58-57-141	D58-57-144
Black		D58-57-151	D58-57-154
Blue		D58-57-211	D58-57-214
Red	D58-57-221	D58-57-224	
Gold	D58-57-231	D58-57-234	
Titanium	D58-57-241	D58-57-244	
Black	D58-57-251	D58-57-254	

ϕ 18 M6 Aluminum Spacer			
Color	Size	4 Pack	20 Pack
Blue	Type11	D58-57-311	D58-57-314
Red		D58-57-321	D58-57-324
Gold		D58-57-331	D58-57-334
Titanium	Type12	D58-57-341	D58-57-344
Black		D58-57-351	D58-57-354
Blue		D58-57-411	D58-57-414
Red	D58-57-421	D58-57-424	
Gold	D58-57-431	D58-57-434	
Titanium	D58-57-441	D58-57-444	
Black	D58-57-451	D58-57-454	

ϕ 20 M6 Aluminum Spacer		
Color	size	10 pack
Blue	Type31	D58-58-114
Red		D58-58-124
Gold		D58-58-134
Titanium		D58-58-144
Black		D58-58-154

STAND



TRANSPORT



TOOL



CONTROL



EXHAUST



ELECTRICAL



DRIVE



BODY



ACCESSORIES





Stainless icon



Steel icon

Steel and Stainless M6 Bolts / Nuts



M6 Steel Flange Bolt

Size	5 pack	25 pack
M6X15-P1.0	D58-31-415	D58-31-815
M6X20-P1.0	D58-31-420	D58-31-820
M6X25-P1.0	D58-31-425	D58-31-825
M6X30-P1.0	D58-31-430	D58-31-830
M6X35-P1.0	D58-31-435	D58-31-835
M6X40-P1.0	D58-31-440	D58-31-840
M6X45-P1.0	D58-31-445	D58-31-845



DRC M6 FLANGE BOLT

M6 X (Thread Length) - P1.0

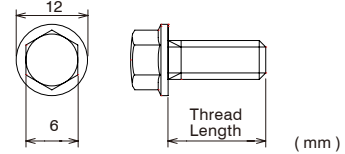

M6 Stainless Flange Bolt

Size	5 pack	15 pack
M6X10-P1.0	D58-35-110	D58-35-210
M6X15-P1.0	D58-35-115	D58-35-215
M6X20-P1.0	D58-35-120	D58-35-220
M6X25-P1.0	D58-35-125	D58-35-225
M6X30-P1.0	D58-35-130	D58-35-230
M6X35-P1.0	D58-35-135	D58-35-235

DRC M6 CAP BOLT

M6 X (Thread Length) = P1.0

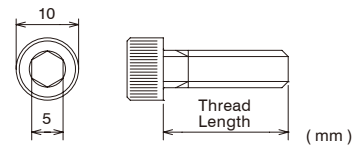

M6 Stainless Cap Bolt

Size	5 pack	15 pack
M6X10-P1.0	D58-35-510	D58-35-610
M6X15-P1.0	D58-35-515	D58-35-615
M6X20-P1.0	D58-35-520	D58-35-620
M6X25-P1.0	D58-35-525	D58-35-625
M6X30-P1.0	D58-35-530	D58-35-630
M6X35-P1.0	D58-35-535	D58-35-635



DRC M6 TAPER BOLT

M6 X (Thread Length) = P1.0

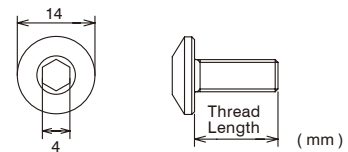

M6 Stainless Taper Bolt

Size	4 pack
M6X10-P1.0	D58-36-010
M6X15-P1.0	D58-36-015
M6X25-P1.0	D58-36-025
M6X30-P1.0	D58-36-030



DRC M6 FLANGE NUT

M6 X - P1.0

M6 nut steel

M6 nut stainless

D58-31-501 5 pack D58-35-801 5 pack
 D58-31-901 25 pack D58-35-901 15 pack



DRC M6 FLANGE LOCK NUT

M6 X - P1.0

D58-31-502 5 pack
 D58-31-902 25 pack



STAND



TRANSPORT



TOOL



CONTROL



EXHAUST



ELECTRICAL



DRIVE



BODY



ACCESSORIES



DRC Steel M6 Bolt / Nut BOX SET

15mm / 20mm / 25mm / 30mm / 35mm / 40mm / 45mm
 (Each x 15 pcs / Nut x 15 pcs)

Part number
 D58-31-098

DRC Stainless M6 Bolt / Nut BOX SET

15mm / 20mm / 25mm / 30mm / 35mm / 40mm / 45mm
 (Each x 15 pcs / Nut x 15 pcs)

Stainless Flange Part number D58-35-001
 Stainless Cap Part number D58-35-401



Make your bike look stylish with anodized aluminum washers and bolts.

* Please check Tightening torque with your service manual.
 Routine screw and bolt torque checking required.
 Please do not use aluminum bolts and nuts in areas of high temperature.



DRC
STAINLESS BRAKE PIN SET

- Features an 8 mm hex head, allowing quick and easy brake pad changes. (Excluding **D58-33-241**)
- Made of SUS304 stainless steel that resists corrosion, heat and galling.
- Comes in a set for each specific configuration.
- Replacement pins are available.

	Bike	Year	Set	Front	Rear
HONDA	CR125R	90-01	D58-33-201	D58-33-072	D58-33-074
		02-07	D58-33-202	D58-33-072	D58-33-093
	CR250R	90-01	D58-33-201	D58-33-072	D58-33-074
		02-07	D58-33-202	D58-33-072	D58-33-093
	CRF250R	04-17	D58-33-202	D58-33-072	D58-33-093
	CRF450R	02-17	D58-33-202	D58-33-072	D58-33-093
	CRF450RX	17	D58-33-202	D58-33-072	D58-33-093
	CRF250X	04-17	D58-33-202	D58-33-072	D58-33-093
	CRF450X	05-16	D58-33-202	D58-33-072	D58-33-093
	XR230	05-12	D58-33-201	D58-33-072	D58-33-074
	XR250/MOTARD	03-07	D58-33-201	D58-33-072	D58-33-074
	SuperXR/Baja	95-02	D58-33-201	D58-33-072	D58-33-074
	XLR250/Baja	89-94	D58-33-201	D58-33-072	D58-33-074
	CRM250R/AR	91-98	D58-33-201	D58-33-072	D58-33-074
	XR400MOTARD	05-07	D58-33-201	D58-33-072	D58-33-074
XR400R	95-04	D58-33-201	D58-33-072	D58-33-074	
XR600R	89-99	D58-33-201	D58-33-072	D58-33-074	
XR650R	00-07	D58-33-201	D58-33-072	D58-33-074	
YAMAHA	YZ125	98-17	D58-33-201	D58-33-072	D58-33-074
	YZ250	98-17	D58-33-201	D58-33-072	D58-33-074
	YZ250F	01-17	D58-33-201	D58-33-072	D58-33-074
	YZ400F	98	D58-33-201	D58-33-072	D58-33-074
	YZ426F	00-02	D58-33-201	D58-33-072	D58-33-074
	YZ450F	03-17	D58-33-201	D58-33-072	D58-33-074
	YZ125X	17	D58-33-201	D58-33-072	D58-33-074
	YZ250X	16-17	D58-33-201	D58-33-072	D58-33-074
	YZ250FX	15-17	D58-33-201	D58-33-072	D58-33-074
	YZ450FX	16-17	D58-33-201	D58-33-072	D58-33-074
	WR250F	01-16	D58-33-201	D58-33-072	D58-33-074
	WR450F	03-16	D58-33-201	D58-33-072	D58-33-074
WR250R	07-17	D58-33-232	D58-33-091	D58-33-074	
WR250X	07-17	D58-33-231	D58-33-074	D58-33-074	
KAWASAKI	KX125	95-96	D58-33-201	D58-33-072	D58-33-074
		97-08	D58-33-221	D58-33-082	D58-33-074
	KX250	95-96	D58-33-201	D58-33-072	D58-33-074
		97-08	D58-33-221	D58-33-082	D58-33-074
	KX250F	04-17	D58-33-221	D58-33-082	D58-33-074
	KX450F	06-17	D58-33-221	D58-33-082	D58-33-074
	KLX450R	06-15	D58-33-221	D58-33-082	D58-33-074
	KLX250/D-TACKER	98-07	D58-33-201	D58-33-072	D58-33-074
SUZUKI	RM125	99-04	D58-33-201	D58-33-072	D58-33-074
		05-08	D58-33-202	D58-33-072	D58-33-093
	RM250	99-04	D58-33-201	D58-33-072	D58-33-074
		05-08	D58-33-202	D58-33-072	D58-33-093
		04-06	D58-33-221	D58-33-082	D58-33-074
	RMZ250	07	D58-33-201	D58-33-072	D58-33-074
		08-17	D58-33-202	D58-33-072	D58-33-093
	RMZ450	05-07	D58-33-201	D58-33-072	D58-33-074
		08-17	D58-33-202	D58-33-072	D58-33-093
	RMX450Z	10-15	D58-33-202	D58-33-072	D58-33-093
RMX250S/R	96-98	D58-33-201	D58-33-072	D58-33-074	
DRZ400S/R	00-05	D58-33-201	D58-33-072	D58-33-074	
DRZ400SM	04-16	D58-33-202	D58-33-072	D58-33-093	
KTM	125-530 SX/SX-F/EXC/EXC-F/XC/XC-W	00-17	D58-33-241	D58-33-096	D58-33-097
HUSQVARNA	CR/WR125	07-12	D58-33-241	D58-33-096	D58-33-097
	TC250	04-13	D58-33-241	D58-33-096	D58-33-097
	TC450	04-10	D58-33-241	D58-33-096	D58-33-097
	TC510	05-10	D58-33-241	D58-33-096	D58-33-097
	TE250	06-13	D58-33-241	D58-33-096	D58-33-097
	TE450	06-10	D58-33-241	D58-33-096	D58-33-097
	TE510	06-10	D58-33-241	D58-33-096	D58-33-097
	TXC250/450/510	08-10	D58-33-241	D58-33-096	D58-33-097
	TC125/250	14-17	D58-33-241	D58-33-096	D58-33-097
	TE125-300	14-17	D58-33-241	D58-33-096	D58-33-097
	FC250-450	14-17	D58-33-241	D58-33-096	D58-33-097
	FE250-501	14-17	D58-33-241	D58-33-096	D58-33-097
	TX125/300	17	D58-33-241	D58-33-096	D58-33-097
FX350/450	17	D58-33-241	D58-33-096	D58-33-097	

Please refer to fitting application below for each configuration.

D58-33-072

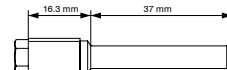

D58-33-074

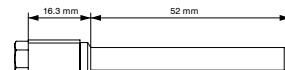

D58-33-082



D58-33-091

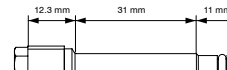

D58-33-093

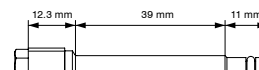

D58-33-096

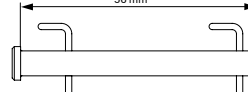

D58-33-097

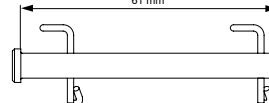

*Clip pin included

Replacement

DRC
KTM BRAKE PIN CLIP SET

Part number **D58-33-095**

Front pin : 2 pcs Rear pin : 2 pcs



DRC
BRAKE SAVER

- Prevents brake pedal from catching on berms, branches and rocks.
- Available colors: Black, Blue and Red.

Part number **D58-19-100** Color Black
D58-19-101 Blue
D58-19-103 Red

DRC
SAFETY WIRE PLATE

- Provides safety wire hooking point on your engine case.
- Place in between engine cover and its bolt near by oil filler or drain bolts.
- Made of stainless steel.
- Comes in 3 plates.

Part number **D58-20-111**



STAND



TRANSPORT



TOOL



CONTROL



EXHAUST



ELECTRICAL



DRIVE



BODY



ACCESSORIES



High heat resistance and durable silicon rubber

Durable mesh fiber

DRC RADIATOR HOSE

- Durable silicone radiator hose for dirt bikes.
- Available for MX, ED racers and street dirt bikes.
- Smooth inner surface allows for increased coolant flow.
- Printed white DRC logo.
- Available in red, blue and orange colors.

Bike	Year	Red	Blue	Hose qty		
HONDA	CR125R	05-07	D47-01-183	-	5	
	CR250R	05-07	D47-01-193	-	5	
	CRF150R	07-17	D47-01-013	-	4	
	CRF250R	04-09	D47-01-043	-	4	
		10-13	D47-01-053	-	4	
		14-15	D47-01-063	-	5	
	CRF250X	16-17	D47-01-033	-	5	
		04-17	D47-01-043	-	4	
		06-08	D47-01-073	-	5	
	CRF450R	09-12	D47-01-083	-	7	
		13-14	D47-01-093	-	6	
	YAMAHA	YZ85	02-17	-	D47-01-602	2
		YZ125	05-17	-	D47-01-782	4
		YZ250	05-17	-	D47-01-792	4
YZ250F		07-09	-	D47-01-642	4	
		10-13	-	D47-01-652	3	
YAMAHA		YZ250F	14-17	-	D47-01-662	4
			06-09	-	D47-01-682	4
	YZ450F	10-13	-	D47-01-692	4	
	WR250F	14-17	-	D47-01-702	4	
		17	-	D47-01-782	4	
KAWASAKI	YZ250X	16-17	-	D47-01-792	4	
	YZ250FX	15-17	-	D47-01-752	4	
	YZ450FX	16-17	-	D47-01-712	4	
	WR250F	07-14	-	D47-01-742	5	
		15-16	-	D47-01-752	4	
	WR450F	07-09	-	D47-01-682	4	
		12-15	-	D47-01-762	4	
	SUZUKI	WR250R/X	16	-	D47-01-712	4
		KX65	07-17	D47-01-723	D47-01-722	3
			01-17	-	D47-01-202	3
KX85		01-13	-	D47-01-212	3	
		14-17	D47-01-223	D47-01-222	3	
SUZUKI		KX100	14-17	D47-01-223	D47-01-222	3
	KX250F	07-08	-	D47-01-232	5	
		09-16	-	D47-01-242	5	
	KX450F	06-08	-	D47-01-272	6	
09-15		-	D47-01-282	6		
SUZUKI	KLX450R	16-17	-	D47-01-292	6	
		08-15	-	D47-01-272	6	
	KLX250/D-TRACKER	93-07	D47-01-313	D47-01-312	5	
		08-16	D47-01-323	D47-01-322	4	
RM85	02-16	D47-01-403	-	2		
RM250	01-08	D47-01-593	D47-01-592	3		
	07-09	D47-01-443	-	5		
RMZ250	10	D47-01-453	-	3		
	11-12	D47-01-463	-	5		
	13-17	D47-01-473	-	6		
RMZ450	08-14	D47-01-483	-	5		
	15-17	D47-01-493	-	5		
RMX450Z	10-15	D47-01-483	-	5		
DRZ400S/SM	00-16	D47-01-523	D47-01-522	3		

Bike	Year	Red	Blue	Orange	Hose qty
KTM	65SX	02-08	-	D47-01-807	3
	65SX	09-15	-	D47-01-827	2
		16-17	-	D47-01-828	2
	85SX	04-12	-	D47-01-817	2
		13-17	-	D47-01-818	2
	125SX	11-15	-	D47-01-988	3
		16-17	-	D47-01-989	3
	150SX	11-15	-	D47-01-988	3
		16-17	-	D47-01-989	3
	250SX	07-10	-	D47-01-997	3
		11-16	-	D47-01-998	3
	250XC	09-10	-	D47-01-997	3
		11-16	-	D47-01-998	3
	300XC	11-16	-	D47-01-998	3
08-10		-	D47-01-837	3	
250SX-F	11-12	-	D47-01-847	3	
	13-15	-	D47-01-957	2	
350SX-F	16-17	-	D47-01-958	3	
	11-15	-	D47-01-957	2	
450SX-F	16-17	-	D47-01-958	3	
	13-15	-	D47-01-878	3	
450SMR	16-17	-	D47-01-879	3	
	08-09	-	D47-01-867	3	
250EXC-F	08-11	-	D47-01-897	2	
	08-11	-	D47-01-927	1	
HUSABERG	WR250/300	06-10	D47-02-193	-	4
	TE, SMR250	10-11	D47-02-053	-	3
	TC250, TXC250	10-11	D47-02-063	-	4
	SMS/TE630	10-11	D47-02-213	-	6
	TC85	14-17	-	D47-01-812	2
	TC125	14-15	-	D47-01-982	3
		16-17	-	D47-01-983	3
	TC250	14-16	-	D47-01-992	3
		14-15	-	D47-01-952	2
	FC250/350	16-17	-	D47-01-953	3
14-15		-	D47-01-872	3	
FC450	16-17	-	D47-01-873	3	

Bike	Year	Red	Blue	Hose qty	
GASGAS	EC200/250/300	07-10	D47-02-233	-	4
	EC200/250/300	11	D47-02-243	-	5
HUSABERG	FE390	10-11	-	D47-02-562	1
	FE450	09-11	-	D47-02-562	1
	FX450	10-11	-	D47-02-562	1
	FE570	09-11	-	D47-02-582	1
APRILIA	FS570	10-11	-	D47-02-582	1
	RXV 450/550	06-11	D47-02-633	-	4
TM	SXV 450/550	06-11	D47-02-633	-	4
	MX, EN, SMR/M 250F 450F/530F	05-11	-	D47-02-462	4

JMX
TEAM SRM

- STAND
- TRANSPORT
- TOOL
- CONTROL
- EXHAUST
- ELECTRICAL
- DRIVE
- BODY
- ACCESSORIES

DRC UNI-FLOW HOSE

- Gas cap hose with one way valve.
- Prevents fuel from flowing out of gas tank.
- Swivel valve design allows smooth removal of gas cap without twisting the gas cap hose.
- Valve is made of A7009-T6 aluminum.
- Available 4 hose colors.

Part number	Color	Part number	Color
D58-08-201	Black	D58-08-203	Blue
D58-08-202	Red	D58-08-206	Orange

DRC RADIATOR CAP

- High pressure radiator cap for racing use.
- High pressure of 1.6 kgf / cm² increases coolant's boiling point.
- Prevents the boiling and vaporization of the coolant during hard riding.
- Protects your engine from overheating.

Part number
D47-31-016



DRC
161 OFF ROAD MIRROR

- Pivot function provides sensitive mirror adjusting.
- Can be folded during hard riding.
- Large viewable mirror body.

Part number	Size
D58-16-110	Right Type
D58-16-120	Left Type
D58-16-140	YAMAHA (Right Type)



STAND



TRANSPORT



TOOL



CONTROL



EXHAUST



ELECTRICAL



DRIVE



BODY



ACCESSORIES



DRC
MIRROR HOLDER

- Universal Mirror holder, best for after market perch or on motorcycles without mirror holes.
- Holder body is Made of A7009 aluminum.
- Stainless steel screws will not rust.
- Available in black and silver colors.

Part number	Color
D41-06-101	Black
D41-06-106	Silver



DRC
MIRROR HOLE PLUG

- Aluminum screw cap to seal your mirror hole.
- Protect your mirror hole thread from water, dust and mud.
- Made of 7009 aluminum, bolt size = M10 - 1.25
- Available in 4 different anodized colors.

Part number	Color	Part number	Color
D41-06-502	Blue	D41-06-508	Titanium
D41-06-503	Red	D41-06-509	Gold



DRC
SKID PLATE FOAM

- Prevents mud from accumulating and adding weight to your machine.
- Installs between your skid plate and engine.

Part number	Size
D58-17-012	300 mm x 150 mm x 40 mm



DRC
KILL SWITCH

- Universal engine kill switch.
- Terminals are included for installation.

Part number
D45-00-100



DRC
GASKET WASHER

- Aluminum gasket washer can be used for drain bolts or gaskets on your bike.
- 6 different washer sizes available.
- Available 5 pcs pack for personal use, 50 pcs pack for shop use.

GASKET WASHER

Parts No	Description	Quantity
D59-52-530	M6	5 pcs
D59-52-540	M8	5 pcs
D59-52-550	M10	5 pcs
D59-52-560	M12	5 pcs
D59-52-565	M12 (KTM)	5 pcs
D59-52-570	M14	5 pcs
D59-52-830	M6	50 pcs
D59-52-840	M8	50 pcs
D59-52-850	M10	50 pcs
D59-52-860	M12	50 pcs
D59-52-865	M12 (KTM)	50 pcs
D59-52-870	M14	50 pcs



DRC
CARGO ANCHOR KNOB

- Provides additional hooking point for your cargo net.
- Easy to mount, just replace with your seat or sub frame bolts.
- Hook body is made of light weight aluminum with anodized finish, bolt is made of stainless steel for less corrosion.
- 2 length of hooks and bolts sizes are available.
- Comes in pairs.

CARGO ANCHOR KNOB

Bolt	A	Parts No
M6	32 mm	D59-51-062
M6	47 mm	D59-51-065
M8	33.5 mm	D59-51-081
M8	48.5 mm	D59-51-085

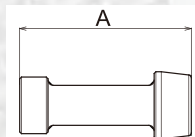

DRC
FOOT PEG HOLDER KLX125/150

- Durable foot peg holder for KLX125/150S.
- Made of 7009 aluminum for extreme strength.
- 25% lighter and 4 times stronger than OE foot peg holder.
- Comes with foot peg pins. Works best with DRC wide foot pegs

Part number
D48-03-211



DRC
FRONT FORK SPRING for KLX125/150

- Hard front fork spring for KLX125/150S.
- Increase spring ratio by 30% more than OE spring.
- Provides more stability for hard off-road riding.
- *Rear suspension adjustment is required. *Can not be used for D-Tracker 125.

Part number
D35-01-113



DRC
ACCESSORIES



DRC
TRACK TAPE

- Track tape for MX and Ed track use.
- Available DF yellow, DRC red.
Width : 75 mm
Length : 200 m per roll

Part number	Description
DF29-7021	DIRTFREAK
DF29-7031	DRC



DRC
PROTECTION CLEAR DECAL

- Clear decals to protect your bikes from scratching, rocks and debris during your ride.
- Thickness : 0.15 mm 3 sheets per package.

Part number	Size
D50-10-010	30 cm (12 inch) x 45 cm (18 inch)

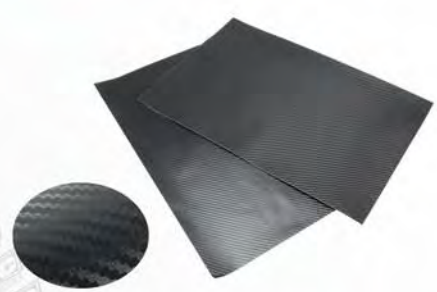

DRC
CARBON LOOK DECAL

- Carbon look decal Sheets. 0.15 mm thick sheet is easy to install even on curved Surfaces.
- Good to use on front outer tube, swing arm, air Box and more. Comes in 2 sheets.

Part number	Size
D50-02-001	30 cm (12 inch) x 45 cm (18 inch)



DRC
BOOTS BAG

Part number	Color
D28-01-020	Black



DRC
EZ MECHANIC BAG

- Compact mechanic bag for race paddock and pit.
- 6 pockets inside of the bag for wrench socket or small tools.
Size W : 35 cm (14 inch) x H : 20 cm (8 inch)

Part number
D27-01-011



DRC
TOOL WRAP

- Easy to carry your tools and other supplies.
- Wrap roll tight and save room when you stow it in your bag.
- Includes small pockets for carrying small things like chain links or fuses.

Part number	Size
D28-05-001	300 mm x 150 mm

*Tools are not included.



DRC
STICKER

Part number	Size
D50-01-102	6 cm (2.3")
D50-01-104	10 cm (4")
D50-01-106	13.5 cm (5.3")



DRC
CAP

Part number	Color
D20-21-111	Black
D20-21-116	Black/White

Size Free (Velcro strap type)

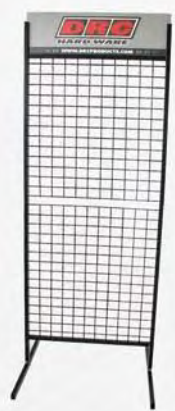

ZETA/DRC
DISPLAY RACK

Size	Part number
70 cm x 190 cm (2.3' x 6.2')	D39-11-111

STAND



TRANSPORT



TOOL



CONTROL



EXHAUST



ELECTRICAL



DRIVE



BODY



ACCESSORIES





COVER
DECAL



MUD
PARTS



EXHAUST



INNER
WEAR



FMX

DAISUKE SUZUKI MX GRIPPER SEAT COVER



MOTION MX GRIPPER SEAT COVER

- Universal seat cover for thin mx type seats.
- Seamless design for better control in hard riding.
- Used by Taka Higashino.

Part number **Color**
MO47-0301 Black

MOTION ALL GRIPPER SEAT COVER

- All gripper design provides excellent seat grip control.
- Simple solid color, fits almost all models.
- Provides excellent no-slip grip.

Part number **Color**
MO47-0101 Black

Detail

Larger seat cover with easy installation material designed to fit most dirt bike models.

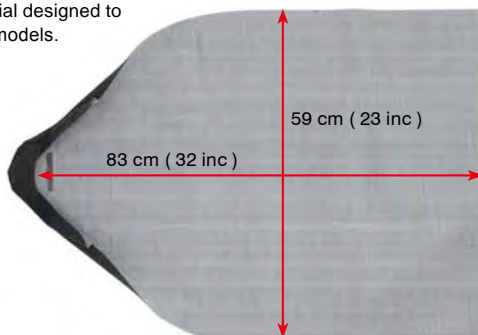

Non-slip, 100% gripper material. Unique shape, and superior sewing, makes installation easy.





MX2

1234567890
1234567890

Full size MX racer For 1 - 2 digit number
Black / White H 16.5 cm (6.5 inch)



ED2

1234567890
1234567890

Head light number plate
Mini MX racer etc. For 1 - 2 digit number
Black / White H 14 cm (5.5 inch)



MN2

1234567890
1234567890

CRF50F / TTR50E etc.
Black / White H 10 cm (4 inch)



MX3

1234567890

Full size MX racer
For 1 - 3 digit number
Black H 16.5 cm (6.5 inch)



ED3

1234567890

Head light number plate
Mini MX racer etc. For 1 - 3 digit number
Black H 14 cm (5.5 inch)



COVER
DECAL

MUD
PARTS

EXHAUST

INNER
WEAR

MOTION

STANDARD NUMBERS

- Standard numbers for number plates.
- Smaller size for recent dirt bikes.
- Available in 3 sizes. Fits MX and pit bike.
- Narrow design for 3 digit numbers. (MX3)
- Cut from 0.1 mm (4 mil) adhesive backed vinyl.
- 3 numbers per pack

Number	MX2 (3 pk)		MX3 (3 pk)		ED2 (3 pk)		ED3 (3 pk)		MN2 (3 pk)	
	Black	White	Black	White	Black	White	Black	White	Black	White
0	MO11-0200	MO11-0210	MO11-0300	MO11-0200	MO11-2200	MO11-2210	MO11-2300	MO11-2310	MO11-3200	MO11-3210
1	MO11-0201	MO11-0211	MO11-0301	MO11-0201	MO11-2201	MO11-2211	MO11-2301	MO11-2311	MO11-3201	MO11-3211
2	MO11-0202	MO11-0212	MO11-0302	MO11-0202	MO11-2202	MO11-2212	MO11-2302	MO11-2312	MO11-3202	MO11-3212
3	MO11-0203	MO11-0213	MO11-0303	MO11-0203	MO11-2203	MO11-2213	MO11-2303	MO11-2313	MO11-3203	MO11-3213
4	MO11-0204	MO11-0214	MO11-0304	MO11-0204	MO11-2204	MO11-2214	MO11-2304	MO11-2314	MO11-3204	MO11-3214
5	MO11-0205	MO11-0215	MO11-0305	MO11-0205	MO11-2205	MO11-2215	MO11-2305	MO11-2315	MO11-3205	MO11-3215
6	MO11-0206	MO11-0216	MO11-0306	MO11-0206	MO11-2206	MO11-2216	MO11-2306	MO11-2316	MO11-3206	MO11-3216
7	MO11-0207	MO11-0217	MO11-0307	MO11-0207	MO11-2207	MO11-2217	MO11-2307	MO11-2317	MO11-3207	MO11-3217
8	MO11-0208	MO11-0218	MO11-0308	MO11-0208	MO11-2208	MO11-2218	MO11-2308	MO11-2318	MO11-3208	MO11-3218
9	MO11-0209	MO11-0219	MO11-0309	MO11-0209	MO11-2209	MO11-2219	MO11-2309	MO11-2319	MO11-3209	MO11-3219

MOTION

FRONT FORK DECAL

- Back printed on high gloss vinyl.
- Uses high quality adhesive.
- Will withstand aggressive riding and pressure washing.
- Sold in pairs.



Clear KYB
Black/White
MO52-0118



Carbon KYB
Red
MO52-0316



Clear Showa
Red/Black
MO52-0112



Carbon Showa
Red/White
MO52-0311

MOTION

FRONT FENDER SIDE DECAL



ZETA Racing
Black
MO33-0701



ZETA Racing
White
MO33-0702



MUD OFF FENDER MAT

- Fender mat set includes mats for front and rear fenders.
- Fender mat keeps your bike lighter in muddy race.
- Easy to install with adhesive back.
- Provides better control by minimizing mud accumulation.
- No need to change suspension ratio because of minimal weight gain.
- Fender mat is very light weight and does not affect motorcycle weight.
- Used by Team HRC, Team SUZUKI, and the Kawasaki Racing Team to get the best race performance result in muddy conditions.

Part number **Mat size**
MD58-0005 Front : 220 mm x 980 mm, Rear : 280 mm x 800 mm



Easy to install, fits on all dirt bikes.

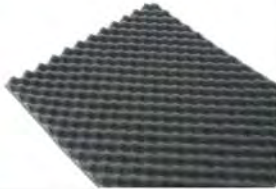

Low water absorption, high elasticity, more than 90 % resilience and a specially finished surface.



Installed FENDER MAT



Not Installed

After a 30 minute ride in muddy conditions, bikes have 23 kgs weight difference in production tests.

COVER DECAL

MUD PARTS

EXHAUST

INNER WEAR

MUD OFF RADIATOR FOAM

- Prevents mud from sticking on the radiator louvers and keeps the radiator cool in a muddy race.
- Provides maximum cooling, and keeps mud and rocks out during a muddy race.
- Easy to install with enclosed zip ties.
- Comes in pairs with zip ties.

Part number **Color**
MD58-1300 Dark Gray



MUD OFF FREE MAT

- Universal mat to prevent sticking mud.
- Easy to install anywhere with the adhesive back.
- Usable on the frame, front fork, swing arm, radiator shroud, upper side of fenders, hand guards, inside of side panel, helmet and more.
- Available in natural white and dark gray.

Part number **Color** **Mat size**
MD58-1001 Natural White 30 cm x 50 cm
MD58-1002 Dark Gray 30 cm x 50 cm

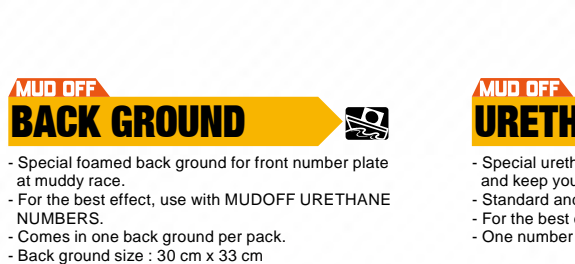

MUD OFF FOOTREST MAT

- Wrap special foam around foot rest movement area to prevent mud getting into this area.
- Keep your step in the right place during muddy race.
- Easy to install, just stick it on your step.
- comes in a pair.

Part number **Color**
MD58-1200 Dark Gray



MUD OFF BACK GROUND

- Special foamed back ground for front number plate at muddy race.
- For the best effect, use with MUDOFF URETHANE NUMBERS.
- Comes in one back ground per pack.
- Back ground size : 30 cm x 33 cm

Part number **Color** **Part number** **Color**
MD50-0001 Red **MD50-0004** Yellow
MD50-0002 Black **MD50-0005** White
MD50-0003 Blue **MD50-0006** Green



MUD OFF URETHANE NUMBERS

- Special urethane foam numbers prevent mud sticking and keep your number viewable during a muddy race.
- Standard and slanted numbers are available.
- For the best effect, use with MUDOFF BACK GROUND.
- One number per pack.

STANDARD



STANDARD part number

Number	Color (size)			
	Black (L)	White (L)	Black (S)	White (S)
#0	MD50-0500	MD50-0600	MD50-0700	MD50-0800
#1	MD50-0501	MD50-0601	MD50-0701	MD50-0801
#2	MD50-0502	MD50-0602	MD50-0702	MD50-0802
#3	MD50-0503	MD50-0603	MD50-0703	MD50-0803
#4	MD50-0504	MD50-0604	MD50-0704	MD50-0804
#5	MD50-0505	MD50-0605	MD50-0705	MD50-0805
#6	MD50-0506	MD50-0606	MD50-0706	MD50-0806
#7	MD50-0507	MD50-0607	MD50-0707	MD50-0807
#8	MD50-0508	MD50-0608	MD50-0708	MD50-0808
#9	MD50-0509	MD50-0609	MD50-0709	MD50-0809

SLANT



SLANT part number

Number	Color (size)			
	Black (L)	White (L)	Black (S)	White (S)
#0	MD50-0100	MD50-0200	MD50-0300	MD50-0400
#1	MD50-0101	MD50-0201	MD50-0301	MD50-0401
#2	MD50-0102	MD50-0202	MD50-0302	MD50-0402
#3	MD50-0103	MD50-0203	MD50-0303	MD50-0403
#4	MD50-0104	MD50-0204	MD50-0304	MD50-0404
#5	MD50-0105	MD50-0205	MD50-0305	MD50-0405
#6	MD50-0106	MD50-0206	MD50-0306	MD50-0406
#7	MD50-0107	MD50-0207	MD50-0307	MD50-0407
#8	MD50-0108	MD50-0208	MD50-0308	MD50-0408
#9	MD50-0109	MD50-0209	MD50-0309	MD50-0409



Comes with a sub visor and 6 tear offs.

MUD OFF RACING SUB VISOR



- Extension sub visor for your helmet.
- Prevents dirt from sticking on your goggles during muddy race or while riding.
- Made of high quality, light weight, clean, low strain, high impact durable, heat resistant, noncombustible plastic.
- Comes with 6 pcs tear offs for the visor.
- Tear off film provides a clear view at once.
- May be used on most helmets for off road riding.

Part number
MD15-0001



MUD OFF HELMET MUDDY COVER



- Prevents mud from sticking on the helmet to keep it light weight.
- Universal fit, can be used for most of off road helmets.
- Comes with visor and chin guard covers.
- Available in blue, red and silver colors.

Part number **Color**
MD15-0101 Red
MD15-0102 Blue
MD15-0103 Silver

COVER
DECAL



MUD
PARTS



EXHAUST



INNER
WEAR



MUD OFF BOOTS COVER



- Boot cover for off road boots.
- Keep the mud out of boots.
- Prevents mud and dirt from entering boot buckle area and inside of the boot.
- Easy to install and remove.
- Available in adult and kids sizes.
- Comes in pairs.

Part number **Description**
MD22-0101 Kids size (M)
MD22-0102 Adult size (L)



MUD OFF MUDDY GROVE



- MUDOFF racing muddy glove is designed for use in a muddy race.
- Knit construction to prevent slippage of your hands from the handlebar grips.
- Wrist belt twisted on the wrist area prevents the glove from coming off during your muddy race.
- Increased handgrip by soaking a little water on the palm. It also can prevent grip slipping when you're running in heavy rain or muddy conditions.
- Tips of index finger and middle finger are made of rubber to increase lever control.

Part number **Size**
MD03-0001 Free Size

MUD OFF TIRE ROLL COVER



- Tire cover helps prevent messing up your truck or van.
- Keep your van clean after the muddy ride.
- Keeps tire clean after washing.
- Used also as a tire cover in the garage.
- Available in 3 different sizes for all dirt bikes.

Part number **Description**
MD58-1010 S (10 - 14 inch)
MD58-1020 M (F 19, R 16 inch)
MD58-1030 L (F 21, R 18-19 inch)



S size M size L size

MUD OFF MECHANIC COLLOID FOAM



- 100% biodegradation soap for Mechanics.
- Liquid soap magically transforms into foam every time you pump.
- Used for hand washing after wrenching, and also on dirty parts.
- One push provides only 1 ml soap.

Part number **Description**
MD51-0050 Mechanic colloid Foam bottle 400 ml
MD51-0051 Mechanic colloid Form refill 400 ml



Pump 400ml

MUD OFF WEAR SHAMPOO



- Detergent for MX wear and gear.
- Pine oil cleaning component cleans all mud and dirt.
- No fluorine, No bleach, No petrochemicals in this detergent.
- Biodegradable.
- Easy to dissolve liquid detergent.

Part number **Description**
MD51-0040 Wear shampoo Bottle 400 ml
MD51-0041 Wear shampoo Form refill 400 ml



Bottle 400 ml

MUD OFF CLEAN DOWN



- Mud cleaner for dirt bikes, cleans all mud on motorcycles.
- Superfine particle colloids in cleaner helps to remove greasy mud and dirt.
- Very high detergency, but it is safe against metal surfaces, plastic and rubber material.
- Made of 100% Brazilian pine sap for biodegradation.
- Available in spray type.

Part number **Description**
MD51-0031 Clean Down Spray 400 ml
MD51-0032 Clean Down Form refill 400 ml



Spray 400 ml



DELTA
BARREL 4 SILENCER

- Improved emission efficiency and exhaust pressure. DELTA BARREL 4 silencer provides high power in the entire power band.
- Special inner silencer body and multi-stage expanding mid pipe design provides power at the high end, and rich torque at bottom and middle bands.

Mid pipe is made of stainless steel. Silencer body is light weight aluminum. Exhaust center of gravity is positioned for motorcycle control performance. The best silencer for street or trail.

Designed for street, enduro, super motard use.

Sound output : **94 db**

FIM approved end-cap design

Use with stock or DELTA head pipe.

Gasket not included. Use stock gasket.

DELTA
BARREL 4-S SILENCER



- JMCA (JAPAN MOTORCYCLE ACCESSORIES ASSOCIATION) approved low noise and emission gas silencer, and provides high power and torque.
- Light weight construction, but quiet and provides more horsepower and torque.

Mid pipe is made of stainless steel. Silencer body is light weight aluminum. Exhaust center of gravity is positioned for motorcycle control performance. The best silencer for street or trail.

Designed for street, enduro, super motard use.

Sound output : **92 db**

Use with stock or DELTA head pipe.

Gasket not included. Use stock gasket.

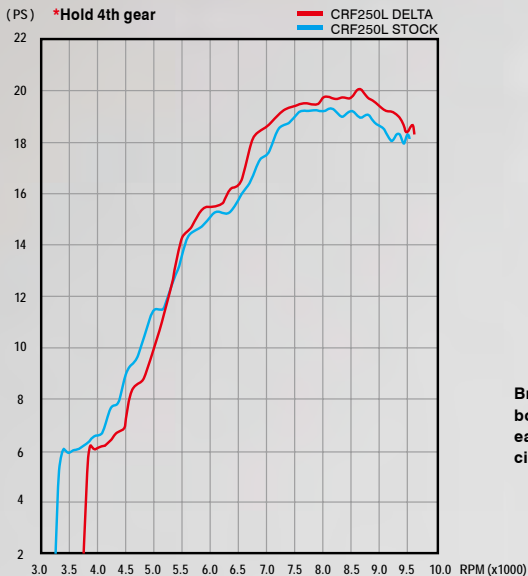

Provides more power and torque than stock pipes
Dyno graph for CRF250L as shown above.

FIM approved aluminum die-cast end cap.

Brushed aluminum finish, light weight silencer body. Uses the best inside restrictor specific for each model. This provide a smooth exhaust gas circulation and increases horse power.

Silencer body and mid pipe are clamped in place by springs.

Multi-stage expanding mid pipe design provides more torque at the middle and bottom ranges.

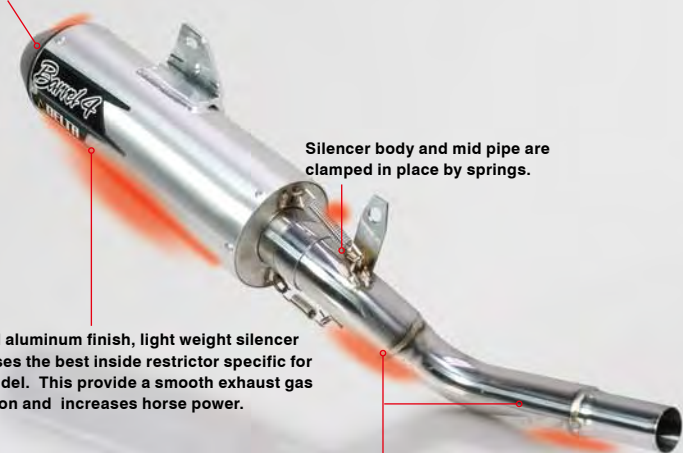



DELTA TORQ HEAD PIPE

- DELTA head pipe for more power and torque when using DELTA silencers.
- Developed for characteristics specific to each bike for more performance.
- Provides better power, acceleration and engine traction than stock head pipe.
- Upgrades performance characteristics for each model.
- Made of SUS304 stainless.

*See below fitting application for part no.

DELTA CARBON TAIL PIECE

- Carbon tail piece for DELTA silencers.
- Made of high quality durable and light weight carbon.
- Perfect fit with DELTA silencer.

Part number
DL99-9813

DELTA SILENCER HEAT PROTECTOR

- Carbon heat protector for DELTA silencers for WR250R/X, Tricker, Serow250, XT250X, and CRF250L/M.
- Helps to prevent burning yourself during your ride.
- Attached with adjustable stainless steel bands.

Part number
DL32-5031

BARREL4 (BARREL4-S) & TORQ HEAD PIPE

DR-Z400SM

D-Tracker X

WR250X

CRF250L

XR230

XR50 Motard

BARREL4 MINI FULL EXHAUST

BIKE	Year	BARREL4	BARREL4-S (JMCA)	TORQ HEAD PIPE
HONDA				
XR50MOTARD	05-07	DL30-4102	DL30-5102	-
XR230	05-07	-	-	DL30-2106
XR230	08-12	DL30-6106	DL30-7106	-
XLR250R/BAJA	89-94	DL30-6109	-	-
XR250/Motard/BAJA	95-07	DL30-6101	DL30-7101	-
CRF250L/M	12-16	DL30-6111	DL30-7111	DL30-2110
YAMAHA				
SEROW225/W/WE	89-04	DL30-6201	-	-
TRICKER	04-07	-	DL30-7202	-
	08-16	-	DL30-7206	-
SEROW250	05-07	DL30-6205	DL30-7202	DL30-2202
	08-16	-	DL30-7207	-
XT250X	06-07	-	DL30-7202	-
	08-16	-	DL30-7207	-
WR250R/X	07-17	DL30-6204	DL30-7204	DL30-2204
KAWASAKI				
KLX125	10-16	DL30-6410	DL30-7411	DL30-2410
D-TRACKER125	10-16	-	DL30-7412	-
KLX250R/SR/ES/D-TRACKER	93-99	-	-	DL30-2401
KLX250/D-TRACKER	01-07	DL30-6402	DL30-7402	-
KLX250	08-16	DL30-6404	DL30-7405	DL30-2402
D-TRACKER X	08-16	-	DL30-7406	-
SUZUKI				
250SB	02-06	DL30-6402	-	DL30-2402
DRZ400S	00-08	DL30-6303	-	DL30-2301
DRZ400SM	05-16	-	DL30-7303	-

* marked part number are full exhaust system

LOW NOISE INNER

- Low noise inner for DELTA Barrel 4 silencer.
- Reduced sound without reduced horsepower.
- Easy to install and remove stock restrictor for replacement.
- Can not be used for Barrel S-4 and Barrel 4 Mini

Part number
DL99-9819

TAIL PIECE

- FIM approved end cap.
- Can not be used for Barrel 4 Mini silencer.

Part number
DL99-9811

RESTRICTOR

Part number
DL99-9817

Size
22 mm



COVER DECAL

MUD PARTS

EXHAUST

INNER WEAR



Mesh Panel

Elbow pad

COVER DECAL

MUD PARTS

EXHAUST

INNER WEAR

DFG NEO FIT SHIRT **COOL MAX*** Vented

- Excellent sweat absorption and quick dry material keeps your body cool by evaporating sweat. Provides comfort during your ride.
- Larger mesh panel used under shoulders and back for efficient ventilation.
- For all season use, even in a hard riding in cold weather conditions.

Part number	size	Color	Material
DG1202-0103	S	Gray	Polyester
DG1202-0104	M		
DG1202-0105	L		
DG1202-0106	XL		

DFG NEO FIT SHIRT **COOL MAX*** Vented-Longsleeve

- Long sleeve shirt using COOL MAX designed for all season.
- Four line fibers provide cooling effect by quick absorption and quick dry.
- Tight fit, shaped shirt used for MX wear and inner jacket.
- Easy to wear with neck brace.
- Mesh material for breathable under arms.
- Breathable to under shoulders in mesh material.
- Light foam sleeve is detachble.
- Compatible with inner pad for sealed layer arm cover.

Part number	size	Color	Material
DG1202-0123	S	Black	Polyester
DG1202-0124	M		
DG1202-0125	L		
DG1202-0126	XL		

DFG NEO FIT SHIRT **THERMOLITE*** Thermal

- Long sleeve inner shirt made of THERMOLITE for warmth, moisture absorption and quick drying in cold weather condition.
- Keeps your body warm by removing moisture during your ride.
- Breathable raised fabric on the back keeps your body warm and dry.
- Lightweight padded elbows, the best under shirt to use in cold weather riding.

Part number	size	Color	Material
DG1202-0013	S	Black	Polyester
DG1202-0014	M		
DG1202-0015	L		
DG1202-0016	XL		



COOL MAX Pad



COOL MAX Pad



Mesh construction

Microfiber fabric for sweat absorption



DFG NEO FIT PANTS **Dry-EX** Vented

- Constructed of superior moisture-absorbing, quick-drying material for comfort during your hard ride.
- Mesh panel on thigh and back side of knee for maximum ventilation.
- For all season use.

Part number	size	Color	Material
DG1201-0113	S	Black	Nylon
DG1201-0114	M		
DG1201-0115	L		
DG1201-0116	XL		

DFG NEO FIT PANTS **THERMOLITE*** Thermal

- Constructed of thermal, quick drying material for winter riding.
- Material keeps dry to prevent cooling by body perspiration.
- Thick wind-proof material and raised lining fabric keeps your body warm on winter rides.

Part number	size	Color	Material
DG1201-1113	S	Black	Polyester
DG1201-1114	M		
DG1201-1115	L		
DG1201-1116	XL		

DFG SWEAT CAP Vented

- Sweat cap especially designed for MX and motorsport riding.
- Wear the sweat cap under your helmet to prevent sweat from getting inside your goggles and/or eyes.
- High water absorption microfiber fabric is placed inside the head band to absorb sweat during your ride.
- Cap body is made of high breathable mesh for comfort.
- Best to use for hard riding in summer and winter seasons.

Part number	size	Color	Material
DG1205-0023	S / M	Black	Polyester
DG1205-0024	L / XL		

Dry-EX
DFG Original functional clothing fabric. Dry-EX. Excellent sweat absorption and quick dry material, keeps your body cool by evaporating heat. Provides good wear comfort during your ride.

SIZE CHART

NEO FIT SHIRT/SHIELD LAYER	(cm)			
	S	M	L	XL
height	155-165	165-175	175-	
chest	82-87	87-92	92-97	97-102
waist	68-73	73-78	78-83	83-88

NEO FIT PANTS	(inch)			
	S	M	L	XL
waist	-30	30-32	32-34	34-

SWEAT CAP	S / M	L / XL
Part A	15 cm	16 cm
Part B	48 cm	52 cm
Stretched width	-58 cm	-62 cm

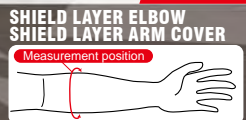
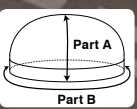



Mesh construction

DFG
SHIELD LAYER *Vented*

- Inner riding shirt integrated with foam pad protection. Developed to be worn under motocross jerseys. Padded abdomen, chest and shoulder area protects your body from small rocks and mud.
- Ergonomic draping design provides comfort as well as a good fit in the riding position.
- Foam pad is designed to be light weight, yet provide protection and mobility along with ventilation for breathability.
- Constructed of superior moisture-absorbent and quick drying material to provide comfort, and to keep your body cool.

Part number	size	chest
DG0201-0101	S / M	80-96 cm (32-38.5 US)
DG0201-0102	L / XL	94-120 cm (37.5-48 US)

SIZE CHART
P 152
material
Nylon / Polyester



DFG
AXIS KNEE SHIN GUARD

- Hard shell type.
- 3 straps hold tightly on your legs.
- Inner soft shell protects knee and shin.
- Vented holes for breathability and comfort.
- 2 piece AXIS SHIN GUARD helps body action.
- Passed EN1621-1

Part number	size	material
DG0803-3101	Adult	Polypropylene
DG0803-3105	Youth / Women	



DFG
AXIS ELBOW GUARD

- Hard shell type.
- Comfort fit design.
- Inner soft shell guards your arm.
- Slits helps remove heat.
- Breathable vented holes.
- Cross type strap attaches tightly on your arm.
- Passed EN1621-1

Part number	size	material
DG0803-1101	Adult	Polypropylene
DG0803-1105	Youth / Women	

COVER
DECAL

MUD
PARTS

EXHAUST

INNER
WEAR



DFG
SHIELD LAYER ELBOW

- Arm sleeve with elbow pad. Stays in place without constriction.
- Light weight and compact design to fit under jersey.
- Made of quick-drying and elasticized material for comfort.
- Available 2 sizes, S/M and L/XL size.
- Comes in pairs.

Part number	size	material
DG0801-1201	S / M 23-28cm (9-11 inch)	Nylon/Polyester
DG0801-1202	L / XL 28cm- (10.5 inch)	

SIZE CHART
P 152

DFG
SHIELD LAYER ARM COVER

- Arm sleeve type elbow guard with CE elbow protector.
- Detachable elbow foam pad passed EN1621-1
- 3 straps hold tightly on your legs.
- Three-dimensional shape sleeve improves comfort fitness.
- Mesh keeps arms breathable.
- Soft foam helps rider's body action.
- Silicon grip and adjustable system prevents slippage.
- Modest design fits any style.
- Less pressure on your body protects from tiredness.
- Protects rider from UV with UPF50+ in long hot weather ride.
- Stretchability and quick dry lasts long in comfortable conditions.
- Works well in hard riding situation.

Part number	size	material
DG0801-4201	S / M	Nylon
DG0801-4203	L / XL	

SIZE CHART
P 152



DFG AIR FLOW SOCKS

- Knee high type socks for MX and dirt bike riding.
- Coolmax fabric keeps your feet comfortable during your ride.
- Cushion construction design for absorbing shocks
- The best socks to use with DFG Neo Fit Pants.
- One size (25 cm - 29 cm)

Part number	color	Part number	color	material
DG1101-1092	Blue	DG1101-1095	Yellow	Polyester
DG1101-1093	Red	DG1101-1096	White	



Poliyou® material

DFG RIDE TECH BOOTS INSOLE

- Developed to use with off road riding boots.
- Made of high elasticity polyurethane insole absorbs shock and vibration during your ride.
- Ergonomic sole design supports your foot, provide better foot control.
- Used Poliyou® material for antibacterial and deodorize insole.
- Surface mesh cloth provides better breathability and fast dry.
- Comes in pairs.
- Free size 25.5cm – 30.0cm / 7 inch – 12 inch

Part number	material
DG0901-0101	Polyurethane/Polyester



DFG RACING TABI SOCKS

- Japanese traditional socks "Tabi," are socks in which the toes are bifurcated where one toe gusset is used for first toe, provides better traction and foot sensitive control.
- "Tabi" socks are developed for motorcycles using these advantages for smooth weight shifting and sensitive brake and shift pedal control.
- Short length design is best used with DFG inner pants to prevent the socks from slipping down and prevent uncomfortable layer build up with the inner pants.
- Long length type is designed to use with short inner pants.
- The material thickness provides a natural fit feel.

SHORT TYPE	size	material
part number		
DG1102-1041	S / M 25.0-27.0cm (7.0-9.0US)	Polyester
DG1102-1042	L / XL 27.5-29.5cm (9.5-11.5US)	

LONG TYPE	size	material
part number		
DG1102-2041	S / M 25.0-27.0cm (7.0-9.0US)	Polyester
DG1102-2042	L / XL 27.5-29.5cm (9.5-11.5US)	

DFG DG5031-1000 size S (6cm)

DFG DG5031-1100 size M (10cm)

DFG STICKERS



JMX TEAM SUZUKI
YOHEI KOJIMA

COVER DECAL

MUD PARTS

EXHAUST

INNER WEAR

DISTRIBUTORS

Region	Country	Company	Web site
Africa	South Africa	Langston Motorsports SA	www.langstonmotorsports.co.za
Asia	China	Perfect Moto China	
Asia	Hongkong	MOTO MART	www.motomartco.com
Asia	Japan	DIRTFREAK	www.dirtfreak.co.jp
Asia	Korea	KR MOTORSPORTS	www.krmotors.co.kr
Asia	Korea	PLOT KOREA	www.plotkorea.com
Asia	Macau	Rider Square	www.ridersquare.com/
Central America	Costa Rica	Motoshop VRC	www.motoshopvrc.com
Central America	El Sarvador	Motoshop VRC	www.motoshopvrc.com
Central America	Guatemala	Motoshop VRC	www.motoshopvrc.com
Central America	Honduras	Motoshop VRC	www.motoshopvrc.com
Central America	Nicaragua	Motoshop VRC	www.motoshopvrc.com
Europe	Andorra	Dream Machine S.L.	www.dream-machine.net
Europe	Austria	AUNER	www.auner.at
Europe	Belgium	Rino Trading	www.rinotrading.be
Europe	Bulgaria	BobI MX	www.bobimx.com
Europe	Cyprus	Japan Motor show	www.japan-motorshow.com
Europe	Czech republic	MTZ Mototechnika s.r.o.	www.mototechnika.cz
Europe	Denmark	EMX Racing	www.emx.se
Europe	Finland	EMX Racing	www.emx.se
Europe	France	MAD	www.mad.fr
Europe	Germany	DIRTFREAK GERMANY (Moto Studio)	www.dirtfreak.de
Europe	Greece	TZORTZOPOULOS	www.tzortzopoulos.gr
Europe	Hungary	AUNER	www.auner.at
Europe	Iceland	NITRO	www.nitro.is
Europe	Italy	RINOLFI	www.rinolfi.it
Europe	Latvia	VILDERS	www.vilders.lv
Europe	Netherlands	HOCO PARTS	www.hocoparts.com
Europe	Norway	RUCO	www.ruco.no
Europe	Poland	MEFO Sport Polska	www.mefo.pl
Europe	Belarus	MEFO Sport Polska	www.mefo.pl
Europe	Portugal	MULTIMOTO	www.multimoto.pt
Europe	Russia	FOKSMOTO	www.foksmoto.ru
Europe	Romania	AUNER	www.auner.at
Europe	Spain	Dream Machine S.L.	www.dream-machine.net
Europe	Sweden	EMX Racing AB	www.emx.se
Europe	Switzerland	Hostettler AG	www.hostettler.com
Europe	UK	MADISON	www.madison.co.uk
Europe	Ukraine	Motoequip company	www.motoequip.com.ua/
Middle East	Israel	DR Mania	https://www.facebook.com/DR.MANIA.MC?fref=photo
Middle East	UAE	SRG Motorsports	www.srg-motorsports.com
Middle East	UAE	Fastos	www.fastos.net
North America	Canada	Kimpex	www.kimpex.com
North America	USA	Advantage Peformance Distributing	www.orderapd.com
North America	USA	Langstonmotorsports	www.langstonracing.com
North America	USA	Wheeling Cycle Supply	www.wheelingcyclesupply.com
North America	USA	Moto Heaven	www.moto-heaven.com
North America	USA	Western Power Sports	www.wps-inc.com
Oceania	Australia	Steve Cramer Products	www.stevecramerproducts.com
Oceania	New Caledonia	SUD MOTORS	sudmotor@offratel.nc
Oceania	New Zealand	Northern Accessories	www.northern.co.nz
South America	Brazil	Jarva Imports	www.jarvaimports.com.br
South America	Chile	PALMAX	www.palmax.cl
South East Asia	Malaysia	RGC SDN. BHD	www.rgcsb.com
South East Asia	Singapore	Ideal Motor Sport	www.idealmotorsport.com.sg
South East Asia	Singapore	SPEED ZONE SUPPLY (DELTA)	www.facebook.com/speedzone.supply
South East Asia	Thailand	DIRTSHOP THAILAND	www.dirtshophailand.com



YAMAHA YSP Racing

ZETA
HIGH PERFORMANCE PRODUCTS

WWW.ZETA-RACING.COM

DRC
HARDWARE

WWW.DRCPRODUCTS.COM

DF DIRT FREAK

2-30 Nakamizno Seto Aichi 489-0005 JAPAN

PHONE : 81-561-86-8390

FAX : 81-561 86-8302

Printed in china DF00-2017

Follow us on   

